

SINAMICS DCM Converter Units

Catalog D 23.1 · 2010















SINAMICS Drives

Answers for industry.

SIEMENS

Related catalogs

<p>SINAMICS G110, SINAMICS G120 D 11.1 Standard Inverters SINAMICS G110D, SINAMICS G120D Distributed Inverters</p> <p>E86060-K5511-A111-A6-7600</p>		<p>SITRAIN ITC Training for Automation and Industrial Solutions Language: German</p> <p>E86060-K6850-A101-B9</p>	
<p>SINAMICS G130 D 11 Drive Converter Chassis Units SINAMICS G150 Drive Converter Cabinet Units</p> <p>E86060-K5511-A101-A4-7600</p>		<p>Interactive Catalog CA 01 Products for Automation and Drives</p> <p>E86060-D4001-A510-C8-7600</p>	
<p>SINAMICS GM150, SINAMICS SM150 D 12 Medium-Voltage Converters</p> <p>E86060-K5512-A101-A2-7600</p>		<p>Industry Mall Information and ordering platform in the Internet: www.siemens.com/industrymall</p>	
<p>SINAMICS S120 D 21.3 Chassis Format Units and Cabinet Modules SINAMICS S150 Converter Cabinet Units</p> <p>E86060-K5521-A131-A2-7600</p>		<p>DVD-ROM included with Catalog D 23.1 · 2010</p> <p>On the DVD-ROM included with Catalog D 23.1 · 2010, you will find:</p> <ul style="list-style-type: none"> • Manuals, SINAMICS DCM and SICROWBAR AC/DC • GSD files • Function block diagrams in the VSD format • Dimension drawings of the DC Converter and Control Module in the DXF and PDF formats • STARTER commissioning tool • Spare parts list in the XLS format • Catalog D 23.1 · 2010 in the PDF format • Information about service and support 	
<p>SIMOREG DC-MASTER DA 21.1 Digital Chassis Converters</p> <p>E86060-K5321-A111-A2-7600</p>			
<p>DC motors DA 12 Sizes 160 to 630 31.5 kW to 1610 kW</p> <p>E86060-K5312-A101-A2-7600</p>			
<p>DC motors DA 12 T Engineering information for Catalog DA 12</p> <p>E86060-T5312-A101-A2-7600</p>			
<p>Motion Control PM 21 SIMOTION, SINAMICS S120 and Motors for Production Machines</p> <p>E86060-K4921-A101-A1-7600 News: E86060-K4921-E101-A1-7600</p>			
<p>SINAMICS S110 PM 22 The Basic Positioning Drive</p> <p>E86060-K4922-A101-A1-7600</p>			

SINAMICS Drives

SINAMICS DCM

Converter Units

Catalog D 23.1 · 2010



The products and systems described in this catalog are manufactured and marketed using a certified quality management system in accordance with ISO 9001/ISO 14001 (Certificate Registration No. AT-00257/1 and AT-00355/1). The certificates are recognized in all IQNet countries.

Refer to the Industry Mall for current updates of this catalog:

www.siemens.com/industrymall

© Siemens AG 2010

Introduction	1
Highlights	2
DC Converter and Control Module	3
Accessories and supplementary components	4
Engineering information	5
Tools and engineering	6
Services and documentation	7
Appendix	8

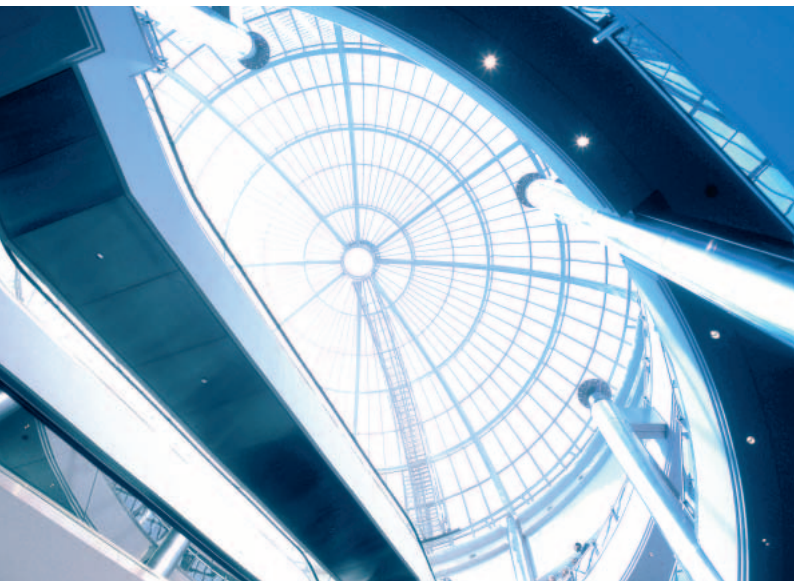
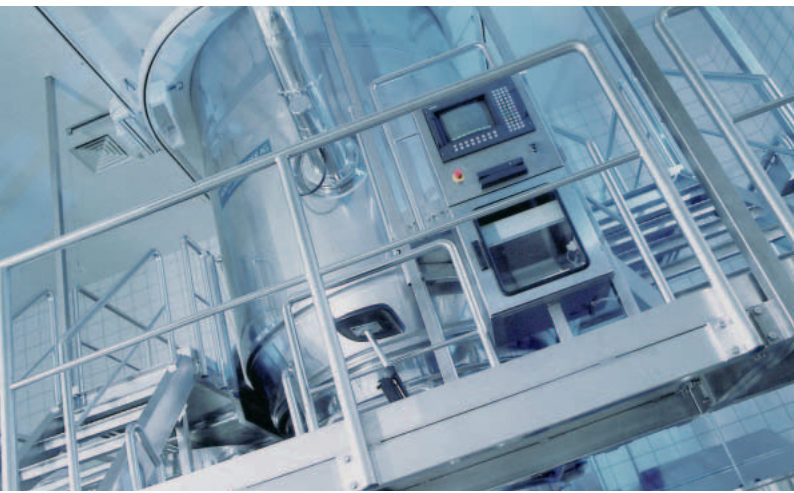

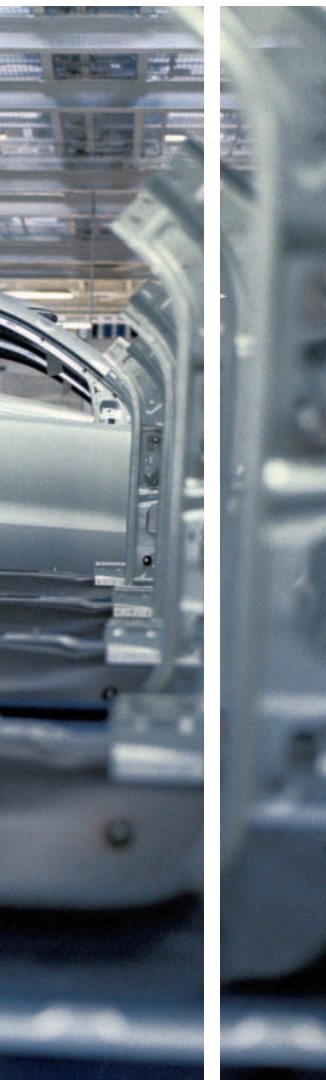

Answers for industry.

Siemens Industry answers the challenges in the manufacturing and the process industry as well as in the building automation business. Our drive and automation solutions based on Totally Integrated Automation (TIA) and Totally Integrated Power (TIP) are employed in all kinds of industry. In the manufacturing and the process industry. In industrial as well as in functional buildings.

Siemens offers automation, drive, and low-voltage switching technology as well as industrial software from standard products up to entire industry solutions. The industry software enables our industry customers to optimize the entire value chain – from product design and development through manufacture and sales up to after-sales service. Our electrical and mechanical components offer integrated technologies for the entire drive train – from couplings to gear units, from motors to control and drive solutions for all engineering industries. Our technology platform TIP offers robust solutions for power distribution.

The high quality of our products sets industry-wide benchmarks. High environmental aims are part of our eco-management, and we implement these aims consistently. Right from product design, possible effects on the environment are examined. Hence many of our products and systems are RoHS compliant (Restriction of Hazardous Substances). As a matter of course, our production sites are certified according to DIN EN ISO 14001, but to us, environmental protection also means most efficient utilization of valuable resources. The best example are our energy-efficient drives with energy savings up to 60 %.

Check out the opportunities our automation and drive solutions provide. And discover how you can sustainably enhance your competitive edge with us.

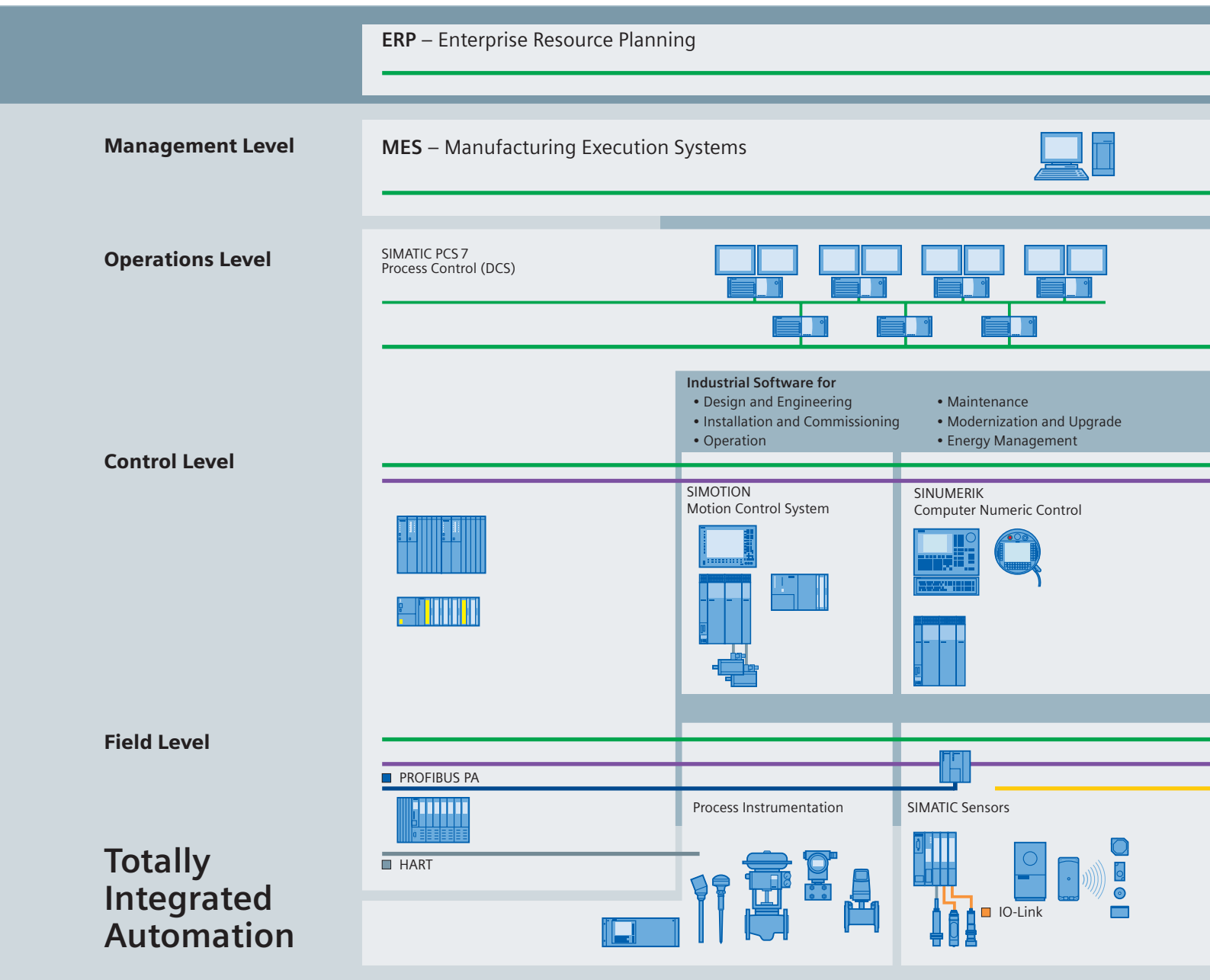

Setting standards in productivity and competitiveness.

Totally Integrated Automation.

Thanks to Totally Integrated Automation, Siemens is the only provider of an integrated basis for implementation of customized automation solutions – in all industries from inbound to outbound.

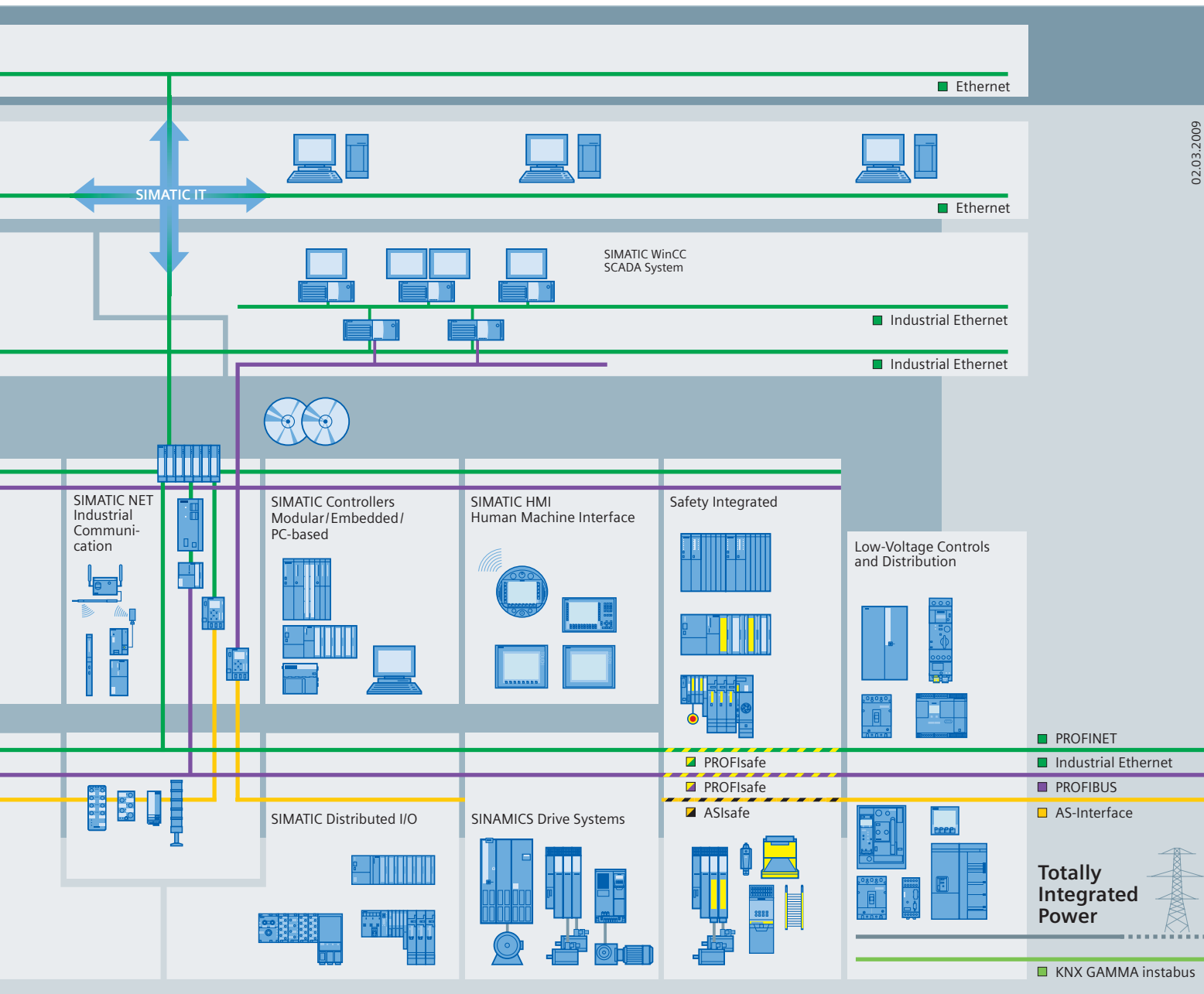

TIA is characterized by its unique continuity.

It provides maximum transparency at all levels with reduced interfacing requirements – covering the field level, production control level, up to the corporate management level. With TIA you also profit throughout the complete life cycle of your plant – starting with the initial planning steps through operation up to modernization, where we offer a high measure of investment security resulting from continuity in the further development of our products and from reducing the number of interfaces to a minimum.

The unique continuity is already a defined characteristic at the development stage of our products and systems.

The result: maximum interoperability – covering the controller, HMI, drives, up to the process control system. This reduces the complexity of the automation solution in your plant. You will experience this, for example, in the engineering phase of the automation solution in the form of reduced time requirements and cost, or during operation using the continuous diagnostics facilities of Totally Integrated Automation for increasing the availability of your plant.



Much more than a catalog. The Industry Mall.

You have a catalog in your hands that will serve you well for selecting and ordering your products. But have you heard of the electronic online catalog (the Industry Mall) and all its benefits? Take a look around it sometime:

www.siemens.com/industrymall



Selecting

Find your products in the structure tree, in the new "Bread-crum" navigation or with the integral search machine with expert functions. Electronic configurators are also integrated into the Mall. Enter the various characteristic values and the appropriate product will be displayed with the relevant order numbers. You can save configurations, load them and reset them to their initial status.

Ordering

You can load the products that you have selected in this way into the shopping basket at a click of the mouse. You can create your own templates and you will be informed about the availability of the products in your shopping cart. You can load the completed parts lists directly into Excel or Word.

Delivery status

When you have sent the order, you will receive a short e-mail confirmation which you can print out or save. With a click on "Carrier", you will be directly connected to the website of the carrier where you can easily track the delivery status.

Added value due to additional information

So you have found your product and want more information about it? In just a few clicks of the mouse, you will arrive at the image data base, manuals and operating instructions. Create your own user documentation with My Documentation Manager. Also available are FAQs, software downloads, certificates and technical data sheets as well as our training programs. In the image database you will find, depending on the product, 2D/3D graphics, dimension drawings and exploded drawings, characteristic curves or circuit diagrams which you can download.

Convinced? We look forward to your visit!

Introduction



1/2	The SINAMICS drive family
1/2	Area of application
1/2	Variants
1/2	Platform concept and Totally Integrated Automation
1/3	Quality according to DIN EN ISO 9001
1/6	The members of the SINAMICS drive family
1/6	<u>SINAMICS DC converters</u>
1/6	• SINAMICS DCM
1/7	<u>SINAMICS low-voltage converters</u>
1/7	• SINAMICS G110
1/7	• SINAMICS G120
1/7	• SINAMICS G110D
1/7	• SINAMICS G120D
1/8	• SINAMICS G130, SINAMICS G150
1/8	• SINAMICS S110
1/8	• SINAMICS S120
1/8	• SINAMICS S150
1/9	<u>SINAMICS medium-voltage converters</u>
1/9	• SINAMICS GM150
1/9	• SINAMICS SM150
1/9	• SINAMICS GL150
1/9	• SINAMICS SL150
1/10	SINAMICS DCM series of converters
1/10	Overview
1/11	The system components of a DC drive
1/11	Overview
1/12	Configuration

SINAMICS DCM

Introduction

The SINAMICS drive family

SINAMICS G

SINAMICS S

SINAMICS DCM



Mixer/mills



Pumps/fans/
compressors



Conveyor systems



Extrusion



Textiles

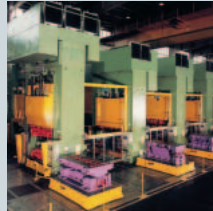

Metal forming
technology

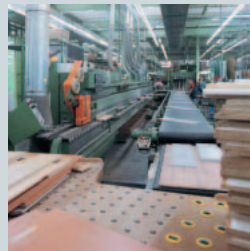

Woodworking

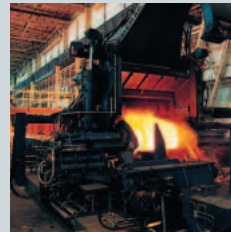

Rolling mills



Packaging



Machine tools

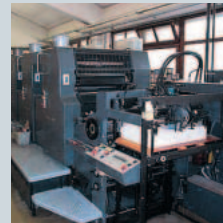

Printing and paper
machines

G_D211_EN_00137

SINAMICS range applications

Area of application

SINAMICS is the new family of drives from Siemens designed for mechanical and plant engineering applications. SINAMICS offers solutions for all drive tasks:

- Simple pump and fan applications in the process industry
- Complex single drives in centrifuges, presses, extruders, elevators, as well as conveyor and transport systems
- Drive line-ups in textile, plastic film, and paper machines, as well as in rolling mill plants
- Highly dynamic servo drives for machine tools, as well as packaging and printing machines

Variants

Depending on the application, the SINAMICS range offers the ideal variant for any drive task.

- SINAMICS G is designed for standard applications with induction motors. These applications have less stringent requirements regarding the dynamic performance of the motor speed.
- SINAMICS S handles complex drive tasks with synchronous/induction motors and fulfills stringent requirements regarding
 - the dynamic performance and accuracy
 - the integration of extensive technological functions in the drive control system
- SINAMICS DC MASTER is the DC drive belonging to the SINAMICS family. As a result of its standard expandability, it fulfills both basic as well as demanding requirements relating to drive technology and complementary markets.

Platform concept and Totally Integrated Automation

All SINAMICS versions are based on a platform concept. Common hardware and software components, as well as standardized tools for design, configuration and commissioning tasks, ensure high-level integration across all components. SINAMICS handles a wide variety of drive tasks without system gaps. The different SINAMICS versions can be easily combined with each other.

SINAMICS is a part of the Siemens "Totally Integrated Automation" concept. Integrated SINAMICS systems covering engineering, data management and communication at the automation level, result in extremely cost-effective solutions based on SIMOTION, SINUMERIK and SIMATIC control systems.

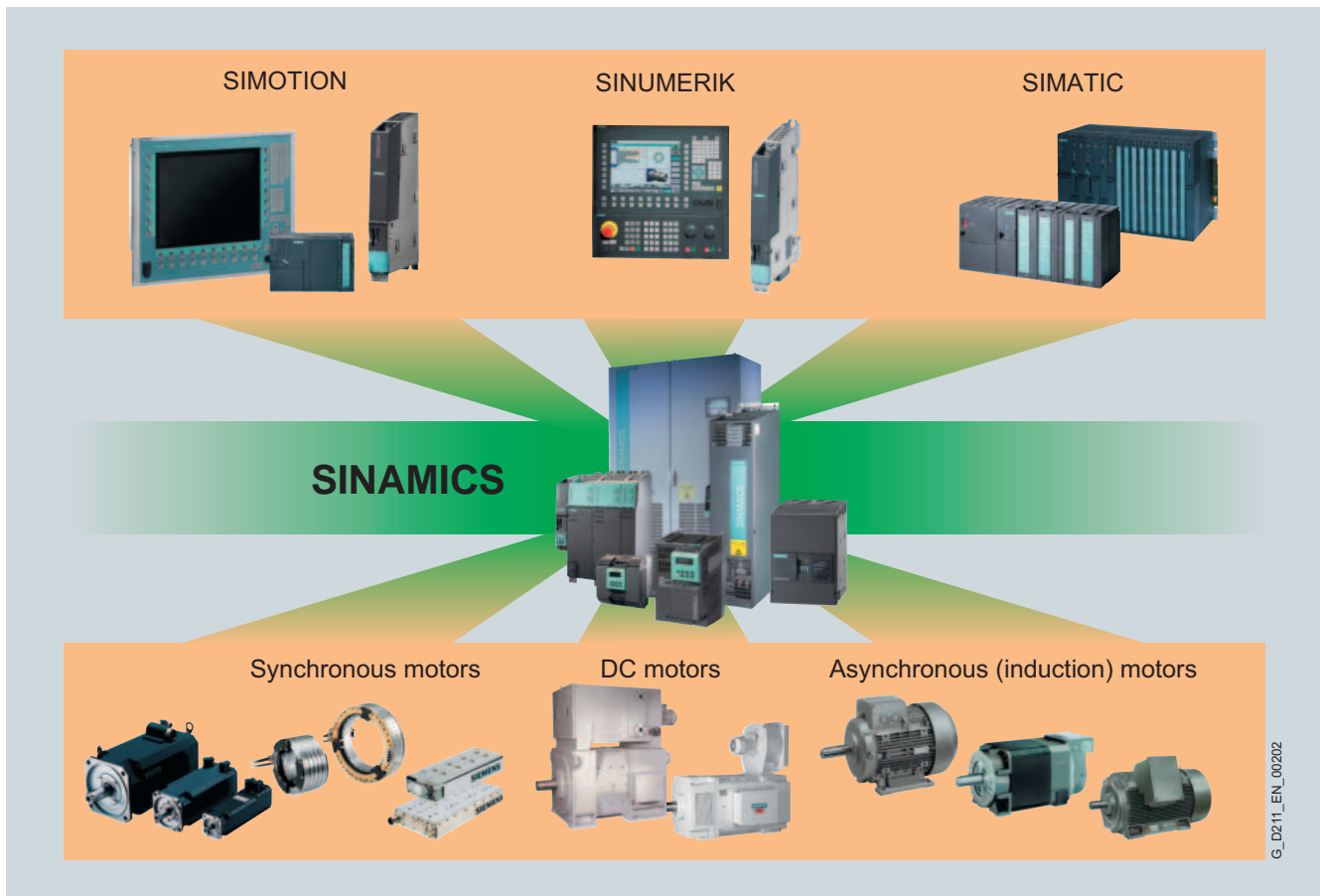

SINAMICS as part of the Siemens modular automation system

Quality according to DIN EN ISO 9001

SINAMICS is able to meet the highest requirements in terms of quality. Comprehensive quality assurance measures in all development and production processes ensure a consistently high level of quality.



Of course, our quality assurance system is certified by an independent authority in accordance with DIN EN ISO 9001.

SINAMICS DCM

Introduction

The SINAMICS drive family

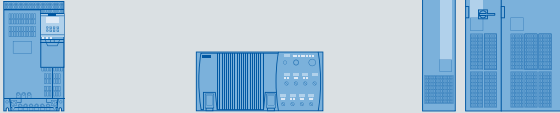
1

Low-Voltage AC Converters					
For basic applications		For high-quality applications			For basic servo drives
 SINAMICS G110 SINAMICS G110D		 SINAMICS G120 SINAMICS G120D SINAMICS G130/G150			 SINAMICS S110
V/f Control	V/f Control/FCC	V/f Control / Vector Control			Servo Control
0.12 ... 3 kW	0.75 ... 7.5 kW	0.37 ... 250 kW	0.75 ... 7.5 kW	75 ... 1 500 kW	0.12 ... 90 kW
Pumps, fans, conveyor belts	Conveyor technology	Pumps, fans, conveyor belts, compressors, mixers, mills, extruders			Single-axis positioning applications for machine and plant engineering
Common Engineering Tools					
SIZER – for simple planning and configuration			STARTER – for fast commissioning, optimization and diagnostics		

Tailored to suit different application areas, the SINAMICS range encompasses the following products:

DC converters (line supply voltage < 1 000 V)

- **SINAMICS DC MASTER** – the scalable drive system for basic and demanding applications

AC low-voltage converters (line supply voltage < 1 000 V)

- **SINAMICS G110** – the versatile drive for low power ratings
- **SINAMICS G120** – the modular single-motor drive for low to medium power ratings
- **SINAMICS G110D** – the distributed, compact single-motor drive in a high degree of protection for basic applications
- **SINAMICS G120D** – the distributed, modular single-motor drive in a high degree of protection for sophisticated applications
- **SINAMICS G130** and **SINAMICS G150** – the universal drive solution for high-performance single-motor drives
- **SINAMICS S110** – the basic positioning drive for single-axis applications
- **SINAMICS S120** – the flexible, modular drive system for demanding drive tasks
- **SINAMICS S150** – the drive solution for demanding high-performance single-motor drives



Medium-voltage converters (line supply voltage > 1 000 V)

- **SINAMICS GM150** – the universal drive solution for single-motor drives
- **SINAMICS SM150** – the drive solution for demanding single-motor and multi-motor drives
- **SINAMICS GL150** – the drive solution for synchronous motors up to 120 MW
- **SINAMICS SL150** – the drive solution for slow speed motors with the highest torques and overloads

The SINAMICS range is characterized by the following system properties:

- Uniform functionality based on a platform concept
- Standardized engineering
- High degree of flexibility and combination capability
- Wide range of performance
- Designed for global use
- SINAMICS Safety Integrated
- Increased economic efficiency and effectiveness
- Versatile interfacing facilities to higher-level controllers
- Totally Integrated Automation

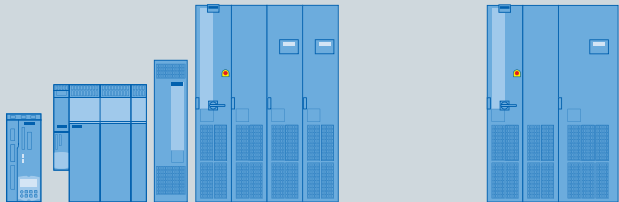
The SINAMICS drive family

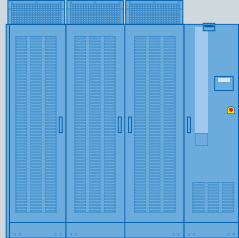
Low-Voltage AC Converters For demanding applications		DC Converters For basic and demanding applications	Medium-Voltage AC Converters For high-power applications
 <p>SINAMICS S120 SINAMICS S150</p>		 <p>SINAMICS DCM</p>	 <p>SINAMICS GM150/SM150/GL150/SL150</p>
V/f Control / Vector Control / Servo Control		Closed-loop speed control / torque control	V/f Control / Vector Control
0.12 ... 4 500 kW	75 ... 1 200 kW	6 kW ... 30 MW	0.8 ... 120 MW
Motion Control applications in production machines (packaging, textile, printing, paper, plastic), machine tools, plants and process lines	Test stands, cross cutters, centrifuges	Rolling mills, cross cutters and shears, wire-drawing machines, extruders and kneaders, presses, elevator and crane installations, cableways and lifts, mining hoists, test stand drives	Pumps, fans, compressors, mixers, extruders, mills, rolling mills, mining hoist drives, excavators, test stands

G_D023_EN_00068

Common Engineering Tools

SIZER – for simple planning and configuration STARTER – for fast commissioning, optimization and diagnostics

SINAMICS DCM

Introduction

The members of the SINAMICS drive family

1

SINAMICS DC converters

SINAMICS DCM



The scalable drive system for basic and demanding applications

Main applications

- Machines and plants in the industrial environment (steel/aluminum, plastics, printing, paper, cranes, mining, oil and gas, excitation equipment) in the new plant and retrofit businesses

Application examples

- Rolling mills
- Cross cutters and shears
- Wire-drawing machines
- Extruders and kneaders
- Presses
- Elevators and cranes
- Cableways and lifts
- Mine hoists
- Test stand drives

Highlights

- PROFIBUS as standard, PROFINET optional
- Variance of the Control Units
- Field power supply in line with requirements
- Electronics power supply for connection to 24 V DC
- Power section isolated with respect to ground
- Free function blocks and Drive Control Chart
- Expandable functionality using SINAMICS components
- Single-phase connection possible
- Coated PCBs and nickel-plated copper busbars
- Wide temperature range

Catalog D 23.1

SINAMICS low-voltage converters

SINAMICS G110



The versatile drive for low power ratings

SINAMICS G120



The modular single-motor drive for low to medium power ratings

SINAMICS G110D



The distributed, compact single-motor drive in a high degree of protection for basic applications

SINAMICS G120D



The distributed, modular single-motor drive in a high degree of protection for sophisticated applications

Main applications

- Machines and plants for industrial and commercial applications
- Machines and plants for industrial and commercial applications (machinery construction, automobile, textiles, chemical industry, printing, steel)
- Horizontal conveyor applications in the industrial environment, with the main focus on distribution and logistics in airports; generally suitable for basic conveyor-related tasks with local control or connected to a bus via AS-Interface
- Conveyor drive applications in industrial environments, main focus on the automotive industry; also suitable for high-performance applications e.g. at airports and in the food, beverage and tobacco industry (without tenside)

Application examples

- Pumps and fans
- Auxiliary drives
- Conveyor systems
- Billboards
- Door/gate operating mechanisms
- Centrifuges
- Pumps and fans
- Compressors
- Conveyor systems
- Conveyor systems
- Conveyor systems
- Airports
- Distribution logistics
- Conveyor systems
- Electric monorail system in distribution logistics

Highlights

- Compact
- Can be flexibly adapted to different applications
- Simple and fast commissioning
- Clear terminal layout
- Optimum interaction with SIMATIC and LOGO!
- Modular
- Can be flexibly expanded
- Simple and fast commissioning
- Regenerative feedback
- Innovative cooling concept
- Optimum interaction with SIMOTION and SIMATIC
- SINAMICS Safety Integrated
- Low profile design with standard drilling dimensions (standard footprint) in IP65 degree of protection
- Simple and fast commissioning
- Versions with and without a maintenance switch
- Optional key-operated switch
- AS-Interface with bus parameterization
- Quick stop function
- Integrated brake control, 180 V DC
- Optimum interaction with SIMATIC and LOGO!
- Low profile design with standard drilling dimensions (standard footprint) in IP65 degree of protection
- Modular
- Can be flexibly expanded
- Simple and fast commissioning
- Regenerative feedback
- Optimum interaction with SIMOTION and SIMATIC
- SINAMICS Safety Integrated

Catalog D 11.1

Catalog D 11.1

Catalog D 11.1

Catalog D 11.1

SINAMICS DCM

Introduction

The members of the SINAMICS drive family

1

SINAMICS low-voltage converters

SINAMICS G130, SINAMICS G150



The universal drive solution for high-performance single-motor drives

SINAMICS S110



The basic positioning drive for single-axis applications

SINAMICS S120



The flexible, modular drive system for demanding drive tasks

SINAMICS S150



The drive solution for demanding high-performance single-motor drives

Main applications

- Machines and plants in the process and production industry, water/waste, power stations, oil and gas, petrochemicals, chemical raw materials, paper, cement, stone, steel
- Machines and plants in the industrial environment, where machine axes should be quickly and precisely positioned in the simplest possible way
- Machines and plants for industrial applications (packaging, plastics, textile, printing, wood, glass, ceramics, presses, paper, lifting equipment, semiconductors, automated assembly and testing equipment, handling, machine tools)
- Machines and plants in the process and production industry, food, beverages and tobacco, automotive and steel industry, mining/open-cast mining, ship-building, lifting equipment, conveyors

Application examples

- Pumps and fans
- Compressors
- Extruders and mixers
- Crushers
- Handling equipment
- Feed and withdrawal devices
- Stacking units
- Automatic assembly machines
- Laboratory automation
- Metalworking
- Woodworking, glass and ceramic industries
- Printing machines
- Plastics processing machines
- Motion Control applications (positioning, synchronous operation)
- Numerical control, interpolating motion control
- Converting
- Technological applications
- Test stand drives
- Centrifuges
- Elevators and cranes
- Cross cutters and shears
- Conveyor belts
- Presses
- Cable winches

Highlights

- Space-saving
- Low noise
- Simple and fast commissioning
- SINAMICS G130: Modular components
- SINAMICS G150: Ready-to-connect cabinet unit
- Optimum interaction with SIMATIC
- Can be universally used
- Flexible and modular
- Scalable in terms of power, functionality, number of axes, performance
- Simple and fast commissioning, auto-configuration
- Innovative, system architecture fit for the future
- (graded infeed / regenerative feedback concepts)
- Wide range of motors
- (Optimum interaction with SIMOTION, SIMATIC and SINUMERIK)
- SINAMICS Safety Integrated
- Can be universally used
- Flexible and modular
- Scalable in terms of power, functionality, number of axes, performance
- Simple and fast commissioning, auto-configuration
- Innovative, system architecture fit for the future
- Graded infeed / regenerative feedback concepts
- Wide range of motors
- Optimum interaction with SIMOTION, SIMATIC and SINUMERIK
- SINAMICS Safety Integrated
- Four-quadrant operation as standard
- High control accuracy and dynamic response
- Minimum harmonic effects on the supply system, considerably lower than the limits specified in IEEE 519 THD
- Tolerant to line voltage fluctuations
- Reactive power compensation option
- Simple and fast commissioning
- Ready-to-connect cabinet unit
- Optimum interaction with SIMATIC

Catalog D 11

Catalog PM 22

Catalogs PM 21, D 11.1 and D 21.3

Catalog D 21.3

SINAMICS medium-voltage converters

SINAMICS GM150



The universal drive solution for single-motor drives

SINAMICS SM150



The drive solution for demanding single-motor and multi-motor drives

SINAMICS GL150

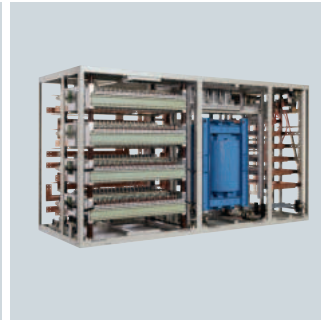

The drive solution for synchronous motors up to 120 MW

SINAMICS SL150



The drive solution for slow speed motors with the highest torques and overloads

Main applications

- Machines and plants in the process industry
- Machines and plants in the steel industry sector (rolling mills) and mining industry
- Machines and plants in the process industry, especially in the oil, gas and petrochemicals sectors
- Machines and plants in the basic materials industry, especially in the steel and mining sectors

Application examples

- Pumps and fans
- Compressors
- Extruders and mixers
- Crushers
- Marine drives
- Hot and cold rolling mill stands
- Mining hoists
- Test stand drives
- Ore conveyor belts
- Compressors
- Pumps and fans
- Extruders and kneaders
- Marine drives
- Blast furnace blowers
- Hot rolling mill roughing stands
- Mine hoists
- Ore and cement mills
- Excavators

Highlights

- Space-saving
- Simple and fast commissioning
- Ready-to-connect cabinet unit
- Optimum interaction with SIMATIC
- Four-quadrant operation as standard
- High degree of efficiency and operation that reduces the stress on the motor
- High control accuracy and dynamic response
- Almost no line harmonics
- Reactive power compensation option
- Simple and fast commissioning
- Ready-to-connect cabinet unit
- Optimum interaction with SIMATIC
- Compact design and high power density
- Simple operator control and monitoring
- Extremely rugged, reliable in operation and almost maintenance-free
- Two directions of rotation by reversing the rotating field
- Can be seamlessly integrated into higher-level automation systems
- Low output frequency/motor speed
- High short-time overload capability
- Four-quadrant operation as standard
- Extremely rugged, reliable in operation and almost maintenance-free
- High efficiency
- Can be seamlessly integrated into higher-level automation systems

Catalog D 12

Catalog D 12

–

–

Overview

SINAMICS DC MASTER is the new generation of DC converters from Siemens. The name SINAMICS DC MASTER – briefly: SINAMICS DCM – embodies the strengths of this new generation. It combines the advantages of its predecessor SIMOREG DC-MASTER, with the advantages of the SINAMICS family.

When it comes to quality, reliability and functionality, SINAMICS DC MASTER is not only on par with its predecessor – but especially in the area of functionality – offers new features and includes useful functions from its predecessor as standard.

SINAMICS DC MASTER is the new member of the SINAMICS family that now makes many of the SINAMICS tools and components known from AC technology available to DC technology.

As scalable drive system, the SINAMICS DC MASTER series of converters is convincing both for basic as well as demanding applications. The DC Converter is equipped with a standard Control Unit (Standard CUD) for standard closed-loop control. The option of combining Standard CUD and Advanced CUD is used to address applications demanding a higher computational performance and more interfaces.

The DC Converter of the SINAMICS DC MASTER series combines the open-loop and closed-loop control and power sections in one device. It especially sets itself apart as a result of the compact, space-saving design.

The AOP30 Advanced Operator Panel and the BOP20 Basic Operator Panel can be used for commissioning and local operation.

The interfaces of the CUD and the number of digital inputs and outputs can be supplemented using additional modules – such as the TM15 and TM31 Terminal Modules.

The components of a DC drive system and how these are logically interlinked are shown in the following diagram. A flow diagram on pages 1/12 and 1/13 provides support when selecting and dimensioning the required components.

The system components of a DC drive

Overview

Motors (see Catalog DA 12)



Motor-side components (see Catalogs D 23.1, LV 60, ET B1-BETA)

Fuses
 SICROWBAR DC
 Smoothing reactors
 (for retrofit for motors with solid yoke and single-phase operation)



SINAMICS DC MASTER components

SINAMICS DC MASTER



Advanced CUD

SINAMICS accessories

For example:
 Terminal Modules,
 Sensor Module,
 Advanced
 Operator Panel,
 PROFINET Board

SIMOREG CCP

Connection system

Line-side components (see Catalogs D 23.1, LV 1, LV 60, ET B1-BETA)

For example:
 Commutating reactor
 Line fuses
 Circuit breaker or contactor
 Radio interference
 suppression filter
 SICROWBAR AC



3 AC line supply

G_D023_EN_00070

SINAMICS DCM

Introduction

The system components of a DC drive

1

Configuration

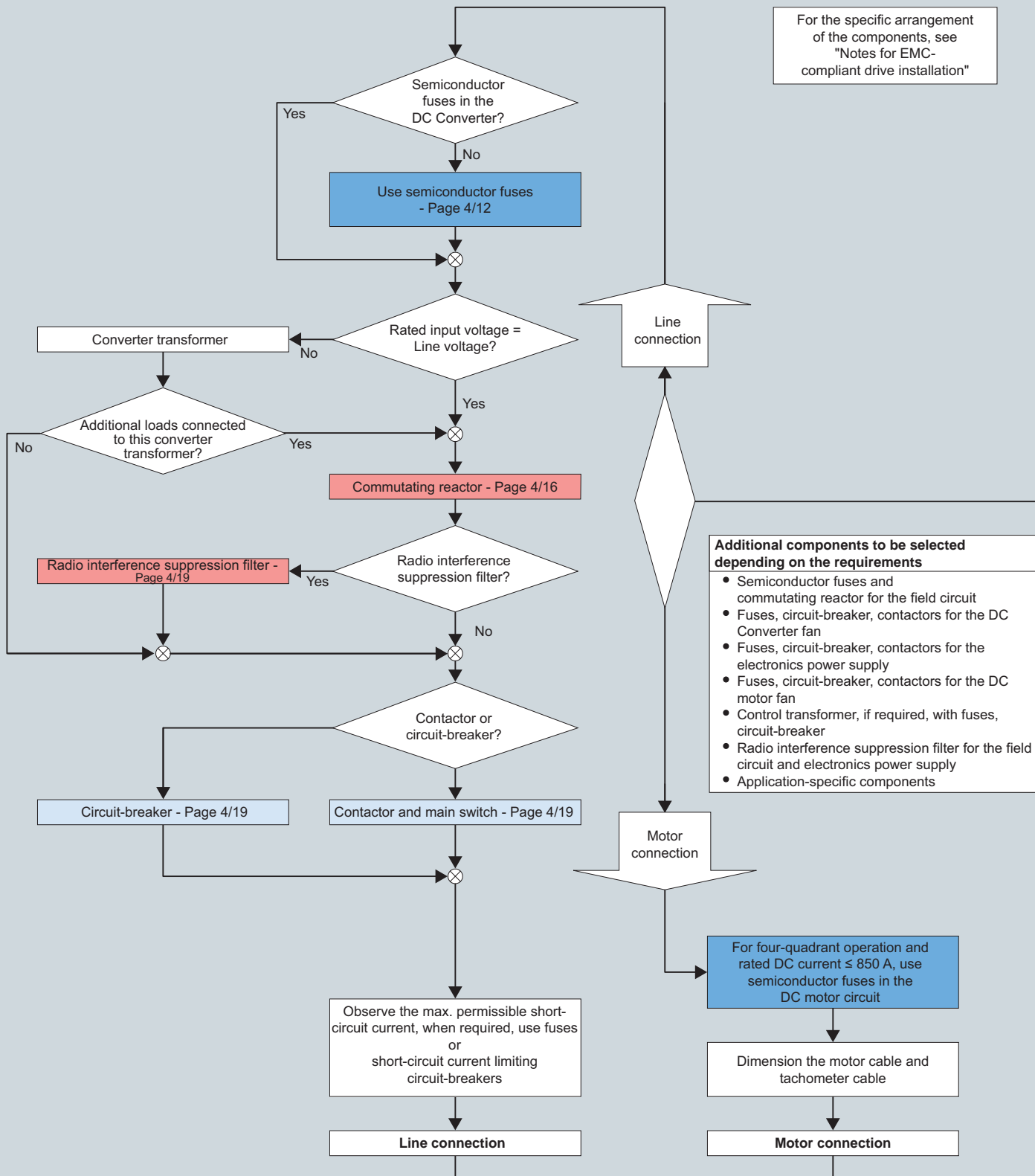

The system components of a DC drive

Configuration (continued)

Configuration start

Motor selection according to the requirements of the driven machine or data of an existing motor

DC armature current
DC armature voltage
Duty cycle
Two-quadrant or four-quadrant operation
Field current and voltage
Select the rated input voltage¹⁾

Determine the DC Converter according to the power data
Pages 3/30 and 3/31

<http://www.siemens.com/dt-configurator>

DC Converter
Data according to the Catalog

Power components

Open-loop & closed-loop control

Electrical and mechanical options

Extended computational performance DC Converter and/or additional options?
Selected according to the table

No → Standard CUD

Yes → Extended

Version	Lefthand slot	Righthand slot	Functionality	Description
1	Standard CUD		Basic functions/PROFIBUS	Page 3/35
2	Advanced CUD		Basic functions + PROFINET with accessory CBE20 + additional inp./outp. with accessory TM31, TM15 + DRIVE-CLiQ	Page 3/35
3	Advanced CUD	Standard CUD	As for version 2 + Expansion of the computational performance	Page 3/35
4	Advanced CUD	Advanced CUD	As for twice version 2 + Expansion of the computational performance	Page 3/35

Select the options

Select the options with the order codes from the option list, Page 3/32

DC Converter with options

Configuration end

- Catalog DA 12 (Page 3/2) and/or SIZER
- Catalog D 23.1 and/or SIZER
- Catalog ET B1 Beta and Catalog D 23.1 and/or SIZER
- Catalog LV 60 and Catalog D 23.1 and/or SIZER
- Catalog LV 1

¹⁾ Directive for selecting the rated input voltage:
a) Voltage is given (e.g. modernization/retrofit)
b) The secondary voltage of the converter transformer can be freely selected corresponding to the requirements of the load or the selected motor (take into account the rated supply voltages of the converter that are available)

G_D023_EN_00059a

SINAMICS DCM

Introduction

Notes

1

Highlights



2/2

2/2

2/2

2/2

2/2

2/3

2/3

2/3

2/3

2/3

2/4

2/4

Overview

- The SINAMICS drive family
- PROFIBUS as standard, PROFINET optional
- Variance of the Control Units
- Field power supply in line with requirements
- 24 V DC electronics power supply
- Power section isolated with respect to ground
- Free function blocks and Drive Control Chart
- Expandable functionality using SINAMICS components
- Single-phase connection is possible
- Coated PCBs and nickel-plated copper busbars
- Wide temperature range

SINAMICS DCM

Highlights

Overview

SINAMICS DC MASTER is the drive system for basic applications and demanding DC applications. The use in a wide range of different sectors and complementary markets demands a high degree of scalability and the ability to expand the converter series over a wide range.

In order to be able to guarantee this versatile use, SINAMICS DC MASTER has a whole raft of new features:

The SINAMICS drive family



SINAMICS DC MASTER is a member of the SINAMICS drive family. The individual SINAMICS versions are based on a common platform, especially in the area of interfaces, tools and operator control & monitoring. All of the SINAMICS drives support the TIA philosophy and share common ways of engineering, communication and data management with the SIMATIC, SIMOTION and SINUMERIK automation systems from Siemens. When using these systems, automation solutions can be very simply generated using SINAMICS. As a result of the standard and seamless integration into the automation environment of Siemens, customers also profit from faster engineering and commissioning of the complete machine automation and drive technology. Further, training-related costs are reduced and support, service & maintenance and spare parts stocking are simplified.

PROFIBUS as standard, PROFINET optional

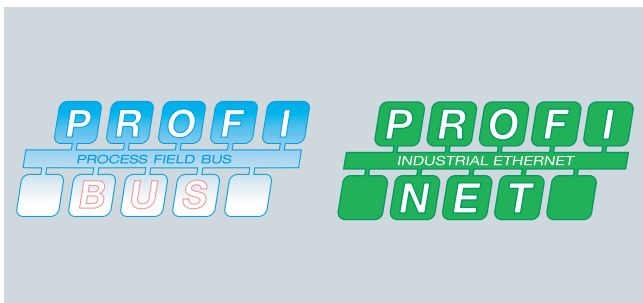

The units are equipped as standard with PROFIBUS – the industry standard. PROFINET is available as option. Communication to other fieldbus systems can be realized using external adapters.

Variance of the Control Units

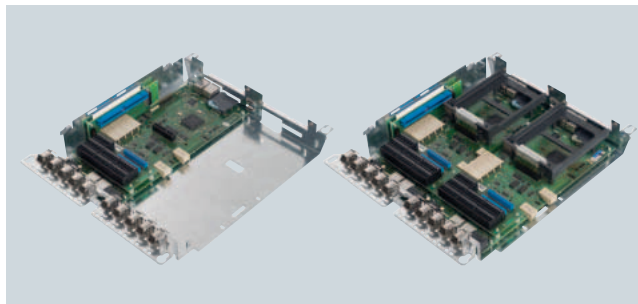

In order to optimally fulfill the requirements relating to interfaces and computational performance for technology functions, a Standard or Advanced CUD or a combination can be selected. It is also possible to use two CUDs to increase the performance for technological open-loop and closed-loop control tasks. This allows optimum adaptation to the wide range of requirements relating to drive technology and complementary markets – both technically and economically.

Field power supply in line with requirements

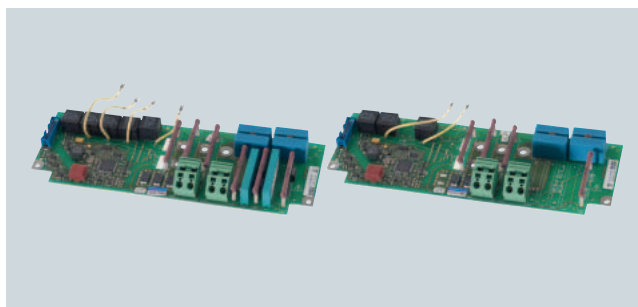

With the introduction of SINAMICS DC MASTER, you have the option of selecting the optimum field power supply for your particular requirements.

SINAMICS DC MASTER is always the optimum choice:

- For units without field (from a rated DC current of 60 A and higher)
- For units with a 1Q field (with integrated free-wheeling circuit)
- For units with a 2Q field to actively reduce the current for high-speed field current changes and integrated field overvoltage protection (from a rated DC current of 60 A and higher)

For units from 1 500 A and higher, it is also possible to select a version with 85 A rated field current in a 1Q or 2Q version instead of the 40 A field power supply.

It goes without saying that an external field power supply unit can also be connected – if the application demands it.

Overview (continued)

24 V DC electronics power supply



The electronics power supply of the DC Converter will be available in two versions:

- For connection to 230 V/400 V AC or
- For connection to 24 V DC (protected against polarity reversal).

Using a 24 V supply, a UPS function can be simply implemented – and therefore the availability of the plant or system increased.

The figure above shows a 24 V DC power supply SITOP smart.

Power section isolated with respect to ground



The power section voltage sensing inside the unit is floating with respect to the electronics (electrically isolated).

This is the reason that in the future it will not be necessary to disconnect/connect the motor cable to measure the insulation resistance of DC motors. In order to secure the availability of the plant or system and to avoid severe damage to the motor, it is absolutely mandatory that the insulation resistance of DC motors is regularly checked.

Free function blocks and Drive Control Chart

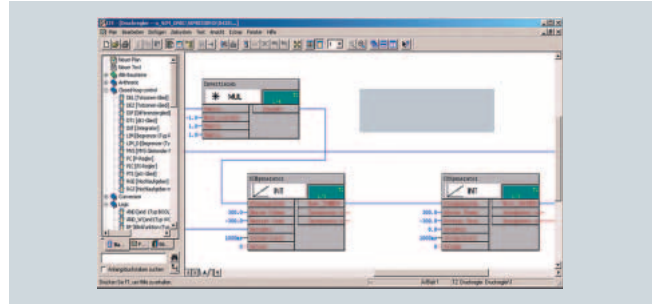

A sufficient number of free function blocks for various applications is included as standard. Optionally, the functional scope can be subsequently extended using free function blocks from Drive Control Chart (DCC). This allows the drive to be optimally adapted to the particular application – both technically and economically.

Expandable functionality using SINAMICS components



Additional inputs and outputs are available by coupling supplementary modules from the SINAMICS range to the DRIVE-CLIQ interface (Advanced CUD). As a consequence, the flexibility when engineering the plant or system is increased and at the same time costs are optimized.

Single-phase connection is possible

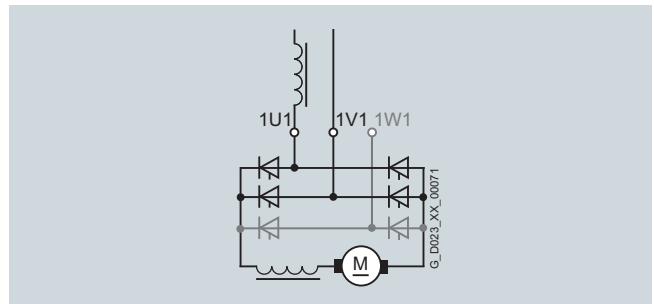

For units up to 125 A and up to 575 V AC, the full functionality is available even when supplied through just two conductors. This means, for example, that when retrofitting a converter with single-phase connection, it is not necessary to make any changes to the existing machine or plant – and the retrofitted drive system can be integrated into state-of-the-art communication concepts (TIA).

SINAMICS DCM

Highlights

Overview (continued)

Coated PCBs and nickel-plated copper busbars

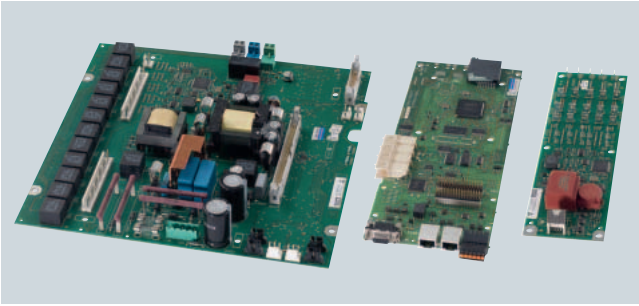

PCBs coated on both sides and nickel-plated copper busbars are two options to improve the reliability for increased degrees of pollution and climatic stressing – as well as for increased environmental stressing (e.g. for aggressive atmospheres).

Wide temperature range



Use in regions with high climatic stressing is made simpler as a result of the -40 °C to $+70\text{ °C}$ temperature range for storage and transport.

DC Converter and Control Module



3/2	General information	3/30	Selection and ordering data
3/2	Overview	3/30	• DC Converters for two-quadrant operation
3/3	Benefits	3/31	• DC Converters for four-quadrant operation
3/3	Application	3/32	Options
3/4	Function	3/32	• Available options
3/4	• Functions of the closed-loop control in the armature circuit	3/33	• Option selection matrix
3/6	• Functions of the closed-loop control in the field circuit	3/34	• Ordering examples
3/6	• Communication between drive components	3/35	• Description of options
3/8	• Single-phase operation	3/37	Schematics
3/8	• Coolant temperature and installation altitude	3/37	• Control Units
3/9	More information	3/38	• DC Converters
3/9	• Documentation	3/39	• Assignment of terminals and connectors
3/10	DC Converter	3/44	More information
3/10	Overview	3/44	• Free function blocks
3/10	Technical specifications	3/45	• Drive Control Chart (DCC)
3/11	• General technical data	3/45	• Power section and cooling
3/12	• SINAMICS DC MASTER converters for:	3/45	• Parameterizing devices
3/12	- 400 V 3 AC, 60 to 280 A, two-quadrant operation	3/46	• Closed-loop control and open-loop drive control
3/13	- 400 V 3 AC, 400 to 1 200 A, two-quadrant operation	3/47	• Optimization run
3/14	- 400 V 3 AC, 1 600 to 3 000 A, two-quadrant operation	3/47	• Monitoring and diagnostics
3/15	- 480 V 3 AC, 60 to 280 A, two-quadrant operation	3/48	• Functions of the inputs and outputs
3/16	- 480 V 3 AC, 450 to 1 200 A, two-quadrant operation	3/49	• Safety shutdown (E-STOP)
3/17	- 575 V 3 AC, 60 to 800 A, two-quadrant operation	3/49	• Serial interfaces
3/18	- 575 V 3 AC, 1 100 to 2 800 A, two-quadrant operation	3/49	• Control terminal block
3/19	- 690 V 3 AC, 720 to 2 600 A, two-quadrant operation	3/50	• Interface to the motor
3/20	- 830 V 3 AC, 950 to 1 900 A and 950 V 3 AC, 2 200 A, two-quadrant operation	3/50	• Siemens DC motors
3/21	- 400 V 3 AC, 15 to 125 A, four-quadrant operation	3/51	Control Module
3/22	- 400 V 3 AC, 210 to 850 A, four-quadrant operation	3/51	Application
3/23	- 400 V 3 AC, 1 200 to 3 000 A, four-quadrant operation	3/51	Design
3/24	- 480 V 3 AC, 15 to 210 A, four-quadrant operation	3/52	Technical specifications
3/25	- 480 V 3 AC, 280 to 1 200 A, four-quadrant operation	3/52	Selection and ordering data
3/26	- 575 V 3 AC, 60 to 850 A, four-quadrant operation	3/52	Options
3/27	- 575 V 3 AC, 1 100 to 2 800 A, four-quadrant operation	3/53	Accessories
3/28	- 690 V 3 AC, 760 to 2 600 A, four-quadrant operation	3/54	Schematics
3/29	- 830 V 3 AC, 950 to 1 900 A and 950 V 3 AC, 2 200 A, four-quadrant operation		

SINAMICS DCM

DC Converter and Control Module

General information

Overview



SINAMICS DC MASTER converter

The SINAMICS DC MASTER series of converters includes the DC Converter and Control Module product versions.

The DC Converter includes built-in units for connection to a three-phase supply. These are used to supply the armature and field of variable-speed DC drives. The rated DC current range of the units extends from 15 to 3 000 A and can be increased by connecting DC Converters in parallel.

Depending on the application, there are units for two-quadrant and four-quadrant operation. The units are autonomous as a result of the integrated parameterization device and do not require any additional equipment for parameterization. All functions associated with open-loop and closed-loop control, as well as all monitoring and auxiliary functions, are handled by a microprocessor system. Setpoints and actual values can either be entered as analog or digital values.

The SINAMICS DC MASTER Control Module is the successor of the SIMOREG CM and is mainly used to retrofit and modernize DC drives.

SINAMICS DC MASTER converters are available in the following sizes (self-ventilated up to 125 A):



DC Converter						Control Module
Rated DC current A						
≤ 30	≤ 280	≤ 600	≤ 850	≤ 1 200	≤ 3 000	–
Dimensions (W × H × D) mm						
268 × 385 × 221	268 × 385 × 252	268 × 625 × 275	268 × 700 × 311	268 × 785 × 435	453 × 883 × 505	271 × 388 × 253

Detailed dimension drawings in the PDF and DXF formats are available on the DVD-ROM supplied with this catalog and in the Internet under www.siemens.com/sinamics-dcm (information material).

Benefits

- Less training time and costs and maximum number of identical parts through the extensive product range of the SINAMICS DC MASTER.
The standard and seamless series of SINAMICS DC MASTER units addresses a wide current and voltage range. The series of units is designed for connection to three-phase line supplies. Furthermore, the units can also be connected to single-phase line supplies up to and including a rated DC current of 125 A.
- Flexible expandability regarding functionality and performance.
The extensive product range and the many options allow the DC Converter to be optimally adapted to customer requirements – both technically and economically. Different customer requirements, the type and number of interfaces as well as the computational performance and speed can be precisely fulfilled by selecting between either a Standard CUD, an Advanced CUD or a combination of both.
- Plant and system availability are increased by being able to quickly and simply replace components.
Replaceable components have been designed so that they can be quickly and simply replaced. The spare parts that are available can be viewed at any time, assigned to the serial number of the unit.
- Easy commissioning and parameterization using interactive menus on the AOP30 Advanced Operator Panel with graphic LCD and plain-text display, or PC-supported using the STARTER commissioning tool (see “Tools and engineering”).
- During the complete production process, all of the components are subject to comprehensive tests and checks. This guarantees a high functional safety.
- Can be easily integrated into automation solutions, e.g. using a standard PROFIBUS communication interface and various analog and digital interfaces.

Application

DC drive technology: Dynamic, rugged and cost effective

Depending on the application, DC drives are frequently the most favorably-priced drive solution. They have many advantages when it comes to reliability, operator friendliness and operating characteristics. Just as before, there are some good technical and economic reasons for still using DC drives in many industrial areas:

- Favorably-priced four-quadrant operation
- Continuous operation at a low speed
- Full torque even at low speeds
- High starting torque
- Wide speed control range with constant power
- Low space requirement and low weight
- Reliability

Main applications for DC drives include:

- Rolling mill drives
- Wire-drawing machines
- Extruders and kneaders
- Presses
- Elevators and cranes
- Cableways and lifts
- Mine hoists
- Test stand drives

SINAMICS DCM

DC Converter and Control Module

General information

Function

Function	Description
Functions of the closed-loop control in the armature circuit	
Speed setpoint	<p>The source of the speed setpoint and additional setpoints can be freely selected by making the appropriate parameter settings:</p> <ul style="list-style-type: none"> • Entered using analog values 0 to ± 10 V, 0 to ± 20 mA, 4 to 20 mA • Using the integrated motorized potentiometer • Using binectors with the functions: Fixed setpoint, jogging, crawl • Entered via serial interfaces of the SINAMICS DC MASTER • Entered via supplementary modules <p>The scaling is realized so that 100 % setpoint (formed from the main setpoint and supplementary setpoints) corresponds to the maximum motor speed.</p> <p>The setpoint can be limited to a minimum and maximum value via a parameter or connector. Further, additional points are provided in the software e.g. in order to be able to enter supplementary setpoints before or after the ramp-function generator. The "setpoint enable function" can be selected using a binector. After a parameterizable filter function (PT1 element), the summed setpoint is transferred to the setpoint input of the speed controller. In this case, the ramp-function generator is also active.</p>
Actual speed	<p>One of four sources can be selected as signal for the speed actual value.</p> <ul style="list-style-type: none"> • <i>Analog tachometer</i> The voltage of the tachogenerator at maximum speed can be between 8 and 270 V. Adaptation to the voltage is realized using parameters. • <i>Pulse encoder</i> The pulse encoder type, the number of pulses per revolution and the maximum speed are set using parameters. Encoder signals (symmetrical: with additional inverted track, unsymmetrical: referred to ground) up to a maximum differential voltage of 27 V can be processed by the evaluation electronics. The rated voltage range (5 or 15 V) for the encoder is selected via parameter. The power supply for the pulse encoder can be taken from the DC Converter for a rated voltage of 15 V. 5 V encoders require an external power supply. The pulse encoder is evaluated across the three tracks: Track 1, track 2 and zero mark. However, pulse encoders without zero mark can also be used. A position actual value can be sensed using the zero mark. The maximum frequency of the encoder pulses can be 300 kHz. It is recommended that pulse encoders with at least 1 024 pulses per revolution are used (due to the smooth running operation at low speeds). • <i>Operation without tachometer with EMF control</i> A speed actual value encoder is not required for closed-loop EMF control. In this case, the output voltage of the device is measured in the DC Converter. The measured armature voltage is compensated by the internal voltage drop across the motor (IR compensation). The level of compensation is automatically determined during the current controller optimization run. The accuracy of this control method, which is defined by the temperature-dependent change in the motor armature circuit resistance, is approximately 5 %. We recommend that the current controller optimization run is repeated when the motor is in the warm operating condition to achieve a higher degree of precision. The closed-loop EMF control can be used if the requirements on the precision are not so high, if it is not possible to mount an encoder and the motor is operated in the armature voltage control range. Notice: In this mode, EMF-dependent field weakening is not possible. • <i>Freely selectable speed actual value signal</i> For this mode, any connector number can be selected as speed actual value signal. This setting is especially selected if the speed actual value sensing is implemented on a supplementary technology module. Before the speed actual value is transferred to the speed controller, it can be smoothed using a parameterizable smoothing element (PT1 element) and two adjustable bandstop filters. Bandstop filters are used primarily for the purpose of filtering out resonant frequencies caused by mechanical resonance. The resonant frequency and the filter quality factor can be set.
Ramp-function generator	<p>When there is a step change in the setpoint applied at its input, the ramp-function generator converts the setpoint into a signal with a steady rate of rise. Ramp-up time and ramp-down time can be selected independently of one another. In addition, the ramp-function generator has initial and final rounding-off (jerk limiting) that are effective at the beginning and end of the ramp-up time.</p> <p>All of the times for the ramp-function generator can be set independently of one another.</p> <p>Three parameter sets are available for the ramp-function generator times; these can be selected via binary select inputs or a serial interface (via binectors). The ramp-up function generator parameters can be switched over in operation. In addition, a multiplication factor can be applied to the value of parameter set 1 via a connector (to change the ramp-function generator data via a connector). When entering ramp-function generator times with the value zero, the speed setpoint is directly input into the speed controller.</p>

Function (continued)

Function	Description
Functions of the closed-loop control in the armature circuit (continued)	
Speed controller	<p>The speed controller compares the setpoint and actual value of the speed and if there is a deviation, enters an appropriate current setpoint into the current controller (principle: Speed control with lower-level current controller). The speed controller is implemented as PI controller with additional D component that can be selected. Further, a switchable droop function can be parameterized. All of the controller parameters can be adjusted independently of one another. The value for K_p (gain) can be adapted depending on a connector signal (external or internal).</p> <p>In this case, the P gain of the speed controller can be adapted depending on the speed actual value, current actual value, setpoint-actual value distance or the wound roll diameter. This can be precontrolled in order to achieve a high dynamic performance in the speed control loop. For this purpose, e.g. depending on the friction and the moment of inertia of the drive, a torque setpoint signal can be added after the speed controller. The friction and moment of inertia compensation are determined using an automatic optimization run.</p> <p>The output quantity of the speed controller can be directly adjusted via parameter after the controller has been enabled.</p> <p>Depending on the parameterization, the speed controller can be bypassed and the converter controlled either with closed-loop torque or current control. In addition, it is also possible to switch between speed control/torque control in operation using the "leading/following switchover" selection function. The function can be selected as binector using a binary user-assignable terminal or a serial interface. The torque setpoint is input via a selectable connector and can therefore come from an analog user-assignable terminal or via a serial interface.</p> <p>A limiting controller is active in the following drive state (torque or current controlled operation). In this case, depending on a speed limit that can be selected using parameters, the limiting controller can intervene in order to prevent the drive accelerating in an uncontrolled fashion. In this case, the drive is limited to an adjustable speed deviation.</p>
Torque limiting	<p>The speed controller output represents the torque setpoint or current setpoint depending on what has been parameterized. In torque-controlled operation, the speed controller output is weighted with the machine flux Φ and transferred to a current limiting stage as a current setpoint. Torque control is applied primarily in field weakening operation in order to limit the maximum motor torque independent of the speed.</p> <p>The following functions are available:</p> <ul style="list-style-type: none"> • Independent setting of positive and negative torque limits using parameters. • Switchover of the torque limit using a binector as a function of a parameterizable switchover speed. • Free input of a torque limit by means of a connector signal, e.g. via an analog input or via serial interface. <p>The lowest specified quantity should always be effective as the actual torque limit. Additional torque setpoints can be added after the torque limit.</p>
Current limiting	<p>The current limit that can be adjusted after the torque limit is used to protect the converter and the motor. The lowest specified quantity is always effective as the actual current limit.</p> <p>The following current limit values can be set:</p> <ul style="list-style-type: none"> • Independent setting of positive and negative current limits using parameters (maximum motor current setting). • Free input of a current limit using a connector, e.g. from an analog input or via a serial interface. • Separate setting of current limit using parameters for stopping and quick stop. • Speed-dependent current limiting: An automatically initiated, speed-dependent reduction of the current limit at high speeds can be parameterized (commutation limit curve of the motor). <p>I^2t monitoring of the power section: The thermal state of the thyristors is calculated for all current values. When the thyristor limit temperature is reached, the unit responds as a function of parameter settings, i.e. the converter current is reduced to the rated DC current or the unit is shut down with a fault message. This function is used to protect the thyristors.</p>
Current controller	<p>The current controller is implemented as PI controller with P gain and integral time that can be set independently from one another. The P and I components can also be deactivated (pure P controller or pure I controller). The current actual value is sensed using a current transformer on the three-phase side and is fed to the current controller via a load resistor and rectification after analog-digital conversion. The resolution is 10 bits for the converter related current. The current limit output is used as current setpoint.</p> <p>The current controller output transfers the firing angle to the gating unit – the precontrol function is effective in parallel.</p>
Precontrol	<p>The precontrol in the current control loop improves the dynamic performance of the closed-loop control. This allows rise times of between 6 and 9 ms in the current control loop. The precontrol is effective dependent on the current setpoint and EMF of the motor and ensures – for intermittent and continuous current or when the torque direction is reversed – that the required firing angle is quickly transferred as setpoint to the gating unit.</p>
Auto-reversing module	<p>In conjunction with the current control loop, the auto-reversing module (only for units with four-quadrant drives) ensures the logical sequence of all of the operations and processes required to change the torque direction. The torque direction can also be disabled when required via parameter.</p>
Gating unit	<p>The gating unit generates the firing pulses for the power section thyristors in synchronism with the line supply voltage. The synchronization is independent of the speed and the electronics supply and is sensed at the power section. The timing of the firing pulses is defined by the output values of the current controller and the precontrol. The firing angle limit can be set using parameters.</p> <p>In a frequency range from 45 to 65 Hz, the gating unit automatically adapts itself to the actual line frequency.</p>

SINAMICS DCM

DC Converter and Control Module

General information

Function (continued)

Function	Description
Functions of the closed-loop control in the field circuit	
EMF controller	The EMF controller compares setpoint and actual value of the EMF (induced motor voltage) and enters the setpoint for the field current controller. This therefore permits field weakening control that is dependent on the EMF. The EMF controller operates as PI controller; P and I components can be adjusted independently of one another and/or the controller can be operated as pure P controller or pure I controller. A precontrol function operates in parallel to the EMF controller. Depending on the speed, it precontrols the field current setpoint using an automatically recorded field characteristic (refer to the optimization runs). There is an adding point after the EMF controller, where the supplementary field current setpoints can be entered either via a connector, via an analog input or a serial interface. The limit is then effective for the field current setpoint. In this case, the field current setpoint can be limited to a minimum and a maximum value that can be set independently from one another. The limit is realized using a parameter or a connector. The minimum for the upper limit or the maximum for the lower limit is effective.
Field current controller	The field current controller is a PI controller – where K_p and T_n can be independently set. It can also be operated as pure P and I controller. A precontrol function operates in parallel to the field current controller. This calculates and sets the firing angle for the field circuit as a function of current setpoint and line supply voltage. The precontrol supports the current controller and ensures that the field circuit has the appropriate dynamic performance.
Gating unit	The gating unit generates the firing pulses for the power section thyristors in synchronism with the line supply voltage in the field circuit. The synchronization is detected in the power section and is therefore independent of the electronics power supply. The timing of the firing pulses is defined by the output values of the current controller and the precontrol. The firing angle limit can be set using parameters. In a frequency range from 45 to 65 Hz, the gating unit automatically adapts itself to the actual line supply voltage.

Communication between drive components

DRIVE-CLiQ	<p>Communication between SINAMICS components is realized using the standard internal SINAMICS interface DRIVE-CLiQ (this is an abbreviation for Drive Component Link with IQ). This couples the Control Unit with the connected drive components (e.g. DC Converter, Terminal Modules etc.).</p> <p>DRIVE-CLiQ provides standard digital interfaces for all SINAMICS drives. This permits modularization of the drive functions and thus increased flexibility for customized solutions (allows power and intelligence to be separated).</p> <p>The DRIVE-CLiQ hardware is based on the Industrial Ethernet standard and uses twisted-pair cables. The DRIVE-CLiQ line provides the transmit and receive signals and also the 24 V power supply.</p> <p>Setpoints and actual values, control commands, status feedback signals and electronic rating plate data of the drive components are transferred via DRIVE-CLiQ. Only original Siemens cables must be used for DRIVE-CLiQ cables. As a result of the special transfer and damping properties, only these cables can guarantee that the system functions perfectly.</p>
SINAMICS Link	<p>SINAMICS Link allows data to be directly exchanged between several (2 to 64) Control Units. A higher-level master is not required.</p> <p>The following Control Units support SINAMICS Link:</p> <ul style="list-style-type: none"> • CU320-2 • Advanced CUD <p>For use of SINAMICS Link, all of the Control Units must be equipped with the CBE20 Communication Board (option G20). In addition, a memory card (options S01, S02) is required for the Advanced CUD. Communication can either be synchronous (only CU320-2) or non-synchronous or a combination of both. Each participant can send and receive up to 16 process data words.</p> <p>For instance, SINAMICS Link can be used for the following applications:</p> <ul style="list-style-type: none"> • Torque distribution for n drives • Setpoint cascading for n drives • Load distribution of drives coupled through a material web • Master/slave function for infeed units • Couplings between SINAMICS units

Function (continued)

Overview, closed-loop control structure

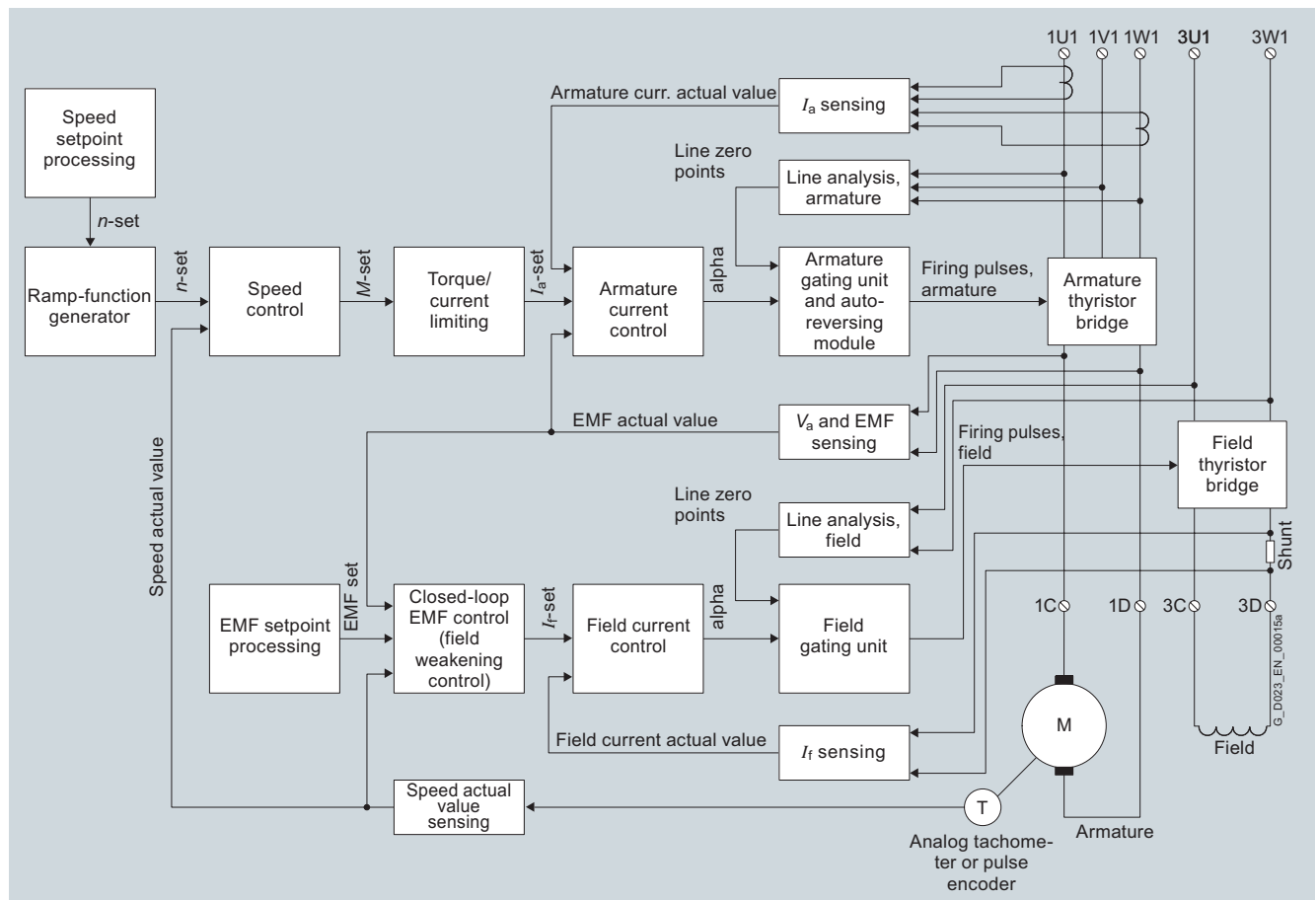

SINAMICS DCM

DC Converter and Control Module

General information

Function (continued)

Single-phase operation

For DC Converters up to 125 A and up to 575 V AC, the full functionality of the devices is available even when supplied through only two conductors.

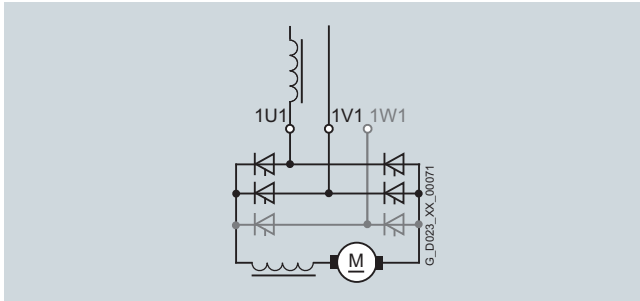

This means, that in a retrofit project for example, a converter with a single-phase connection can be integrated into state-of-the-art communication concepts (TIA) without requiring any changes to the existing machine or plant.

The unit is connected to the line supply via terminals 1U1 and 1W1. It is mandatory that a single-phase commutating reactor or a transformer with 4 % u_k is provided, which only supplies the DC Converter involved.

Commutating reactor and transformer should be selected according to the rated motor current of the armature circuit.

In this B2 circuit, the line current is equal to the DC current in the armature circuit. All of the other line-side drive components should be dimensioned according to this.

Further, due to the higher current ripple when compared to six-pulse operation, a smoothing reactor must be provided in the DC circuit. Please contact the motor manufacturer when dimensioning the smoothing reactor.

The associated technical data of the three-phase converter in single-phase operation is provided in section "Technical specifications" under DC Converter. (Compared to three-phase operation, a derating factor 0.7 must be taken into account for the rated DC current.)

Rated output voltage for single-phase operation

Line supply V	Rated output voltage for single-phase operation	
	Two-quadrant operation V	Four-quadrant operation V
230	180	160
400	320	280
480	385	335
575	460	400

Coolant temperature and installation altitude

Current derating

The permissible coolant temperatures and installation altitudes for SINAMICS DC MASTER as well as the associated maximum permissible load of the DC Converters in continuous operation can be taken from the following table (the load is specified as a % of the rated DC current).

Ambient or coolant temperature	Maximum permissible load of the DC Converter in continuous operation (the load is specified as a % of the rated DC current)									
	Installation altitude above sea level (The derating factors for values in between can be determined using linear interpolation.)									
	1 000 m		2 000 m		3 000 m		4 000 m		5 000 m	
	Units up to 125 A	Units from 210 A and higher	Units up to 125 A	Units from 210 A and higher	Units up to 125 A	Units from 210 A and higher	Units up to 125 A	Units from 210 A and higher	Units up to 125 A	Units from 210 A and higher
30 °C	100 %			98 %	96 %	88 %	86 %	78 %	78 %	70 %
35 °C	100 %			93 %	90 %	83 %	80 %	73 %		
40 °C	100 %			94 %	88 %	84 %	78 %			
45 °C	100 %		95 %	88 %	83 %					
50 °C	94 %	90 %	82 %	78 %						
55 °C	88 %									

Voltage derating

The units can be operated up to an installation altitude of 4 000 m above sea level with the specified rated supply voltages. The line supply voltages may have overvoltage category III with respect to ground. For installation altitudes above 4 000 m, in some cases, it will be necessary to reduce the supply voltage or ensure that overvoltage category II is maintained. Detailed information is provided in the Operating Instructions.

More information

Documentation

The technical documentation includes the following manuals:

- SINAMICS DC MASTER DC Converter Operating Instructions
- SINAMICS DC MASTER Control Module Operating Instructions
- List Manual (parameter lists and function diagrams)
- Function Manual SINAMICS Free function blocks

Documentation is provided on a DVD when the converter is supplied. German, English, French, Spanish, Italian and Russian are the standard languages. The documentation can be separately ordered as hard copy in the languages specified above.

The manuals include all of the data relevant to SINAMICS DC MASTER units:

- Description
- Technical data
- Installation instructions
- Commissioning guide
- Maintenance information
- Function diagrams
- Description of faults and alarms
- Parameter list
- List of connectors and binectors
- Dimension drawings

Documentation on DVD

The product DVD contains all of the operating instructions, both for DC Converters as well as the Control Module in electronic form as PDF files.

The DVD also includes application documents about the use and application of DC drives, on topics such as

- Axial winders
- 12-pulse applications
- Leading-following switchover (MASTER slave operation)
- SINAMICS DC MASTER as field supply unit
- Engineering tips

These documents are being continually supplemented and expanded.

Additional information and ordering data for the various documents are provided in the catalog section "Services and documentation".

SINAMICS DCM

DC Converter and Control Module

DC Converter

Overview



The series of SINAMICS DC MASTER DC Converters includes:

- The electronics module with the Control Unit (CUD) and the slot for expansion using another CUD (in a cradle that can be swiveled out),
- The power section with thyristors in a fully-controlled three-phase bridge circuit configuration (two-quadrant drive: B6C or four-quadrant drive: (B6) A (B6) C),
- A fan (up to 125 A: self-ventilated),
- A single-quadrant field power section with integrated free-wheeling circuit (optionally, also without field or as two-quadrant field with integrated field overvoltage protection),
- The electronics power supply,
- A standard BOP20 operator panel (AOP30 Advanced Operator Panel as accessory).

Technical specifications

General technical data

Relevant standards

EN 50178	Electronic equipment for use in power installations
EN 50274	Low-voltage switchgear and controlgear assemblies: Protection against electric shock – Protection against unintentional direct contact with hazardous live parts
EN 60146-1-1	Semiconductor converters: General requirements and line-commutated converters; specification of basic requirements
EN 61800-1	Adjustable speed electrical power drive systems, Part 1 – (DC drives) General requirements – Rating specifications for low-voltage DC power drive systems
EN 61800-3	Adjustable speed electrical power drive systems, Part 3 – EMC product standard including specific test methods
EN 61800-5-1	Adjustable speed electrical power drive systems – Part 5-1: Requirements regarding safety – electrical, thermal, and energy requirements
IEC 62103 (identical to EN 50178)	Electronic equipment for use in power installations
UBC 97	Uniform Building Code

Electrical specifications

Overvoltage category	Category II acc. to EN 61800-5-1 within the line supply circuits Category III acc. to EN 61800-5-1 for line supply circuits with respect to the environment (other line supply circuits, housing, electronics)
Overvoltage strength	Class 1 acc. to EN 50178
Radio interference suppression	No radio interference suppression according to EN 61800-3

Mechanical data

Degree of protection	IP00 acc. to EN 60529; IP20 with accessories "Mounting kit to upgrade to IP20" for units up to 850 A
Protection class	Class 1 acc. to EN 61140
Cooling method	<ul style="list-style-type: none"> • Units \leq 125 A rated DC current: Permissible ambient temperature in operation 0 ... 45 °C – for higher ambient temperature, refer to current derating on page 3/8 • Units \geq 210 A rated DC current: Permissible ambient temperature in operation 0 ... 40 °C – for higher ambient temperature, refer to current derating on page 3/8
Closed-loop control stability	<ul style="list-style-type: none"> • for pulse encoder operation and digital setpoint $\Delta n = 0.006$ % of the rated motor speed • for analog tachometer and analog setpoint ¹⁾ $\Delta n = 0.1$ % of the rated motor speed
MTBF	> 170 000 h

¹⁾ Conditions:

The closed-loop control (PI control) stability is referred to the rated motor speed and applies when the SINAMICS DC MASTER is in the warm operating condition. This is based on the following preconditions:

- Temperature changes of ± 10 °C
- Line supply voltage changes of +10 % / -5 % of the rated input voltage
- Temperature coefficient of the tachometer generator with temperature compensation 0.15 ‰ every 10 °C (for analog tachometer generators only)
- Constant setpoint

Technical specifications (continued)

General technical data

Environmental conditions

Permissible ambient temperature during storage and transport	-40 ... +70 °C
Permissible humidity	Relative humidity ≤ 95 % (75 % at 17 °C average annual value, 95 % at 24 °C max., condensation not permissible)
Climate class	3K3 acc. to EN 60721-3-3
Insulation	Pollution degree 2 according to EN 61800-5-1 Condensation not permissible
Installation altitude	≤ 1 000 m above sea level (100 % load capability) > 1 000 ... 5 000 m above sea level (see under "Coolant temperature and installation altitude" on page 3/8)

Mechanical strength

	Storage	Transport	Operation
Vibratory load	1M2 acc. to EN 60721-3-1 (dropping not permissible)	2M2 acc. to EN 60721-3-2 (dropping not permissible)	Constant deflection: 0.075 mm at 10 to 58 Hz Constant acceleration: 10 m/s ² at > 58 to 200 Hz (testing and measuring techniques acc. to EN 60068-2-6, Fc)
Shock load			100 m/s ² at 11 ms (testing and measuring techniques acc. to EN 60068-2-27, Ea)

Approvals

UL/cUL	UL file No.: E203250
UL 508 C (UL Standard for Power Conversion Equipment)	Certification of the units up to and including 575 V
GOST	
Lloyd's Register	In order to maintain the important limit values for marine certification, radio interference suppression filters should be used (see "Accessories and supplementary components") and option M08 should be selected (coated PCBs).
Det Norske Veritas	
American Bureau of Shipping	
Germanische Lloyd	

SINAMICS DCM

DC Converter and Control Module

DC Converter

Technical specifications (continued)

SINAMICS DC MASTER converters for 400 V 3 AC, 60 to 280 A, two-quadrant operation

	Type	Type				
		6RA8025-6DS22-0AA0	6RA8028-6DS22-0AA0	6RA8031-6DS22-0AA0	6RA8075-6DS22-0AA0	6RA8078-6DS22-0AA0
Rated armature supply voltage ¹⁾	V	400 V 3 AC (+15/-20 %)				
Rated armature input current	A	50	75	104	174	232
Rated supply voltage, electronics power supply	V	380 (-25 %) ... 480 V (+10 %) 2 AC; $I_n = 1$ A or 190 (-25 %) ... 240 V (+10 %) 2 AC; $I_n = 2$ A				
Rated fan supply voltage	V	Self-ventilated			24 V DC internal	
Rated fan current	A				Internal supply	
Air flow	m ³ /h				300	
Sound pressure level ²⁾	dB (A)				52.4	
Rated field supply voltage ¹⁾	V	400 V 2 AC (+15/-20 %)				
Rated frequency	Hz	45 ... 65				
Rated DC voltage ¹⁾	V	485				
Rated DC current	A	60	90	125	210	280
Overload capability	$x \times I_n$	1.8				
Rated power	kW	29	44	61	102	136
Power loss at rated DC current	kW	0.25	0.36	0.41	0.69	0.81
Rated DC field voltage ¹⁾	V	max. 325				
Rated DC field current	A	10			15	
Normal ambient temperature in operation ³⁾	°C	0 ... +45			0 ... +40	
Storage and transport temperature	°C	-40 ... +70				
Installation altitude above sea level ³⁾		≤ 1 000 m for rated DC current				
Dimensions						
• Width	mm	268				
• Height	mm	385				
• Depth	mm	252				
Weight, approx.	kg	10	14			15

Note:

Detailed dimension drawings in the PDF and DXF formats are available on the DVD-ROM supplied with this catalog and in the Internet under www.siemens.com/sinamics-dcm (information material).

Data for single-phase operation

	Type	Type		
		6RA8025-6DS22-0AA0	6RA8028-6DS22-0AA0	6RA8031-6DS22-0AA0
Rated DC voltage	V	320		
Rated DC current	A	42.0	63.0	87.5

¹⁾ The armature/field supply voltage may be lower than the rated armature/field voltage (set via parameter; in the case of units with a 400 V rated voltage, an input voltage of up to 85 V is permitted). The output voltage decreases accordingly. The specified DC output voltage can be maintained up to an undervoltage of 5 % of the line supply voltage (rated armature/field supply voltage).

²⁾ Fan noise for a unit installed in an IP20 electrical cabinet (door closed, 50 Hz operation or operation at 24 V DC for units with an internal supply).

³⁾ Derating factors for higher temperatures and installation altitudes, see page 3/8.

Technical specifications (continued)

SINAMICS DC MASTER converters for 400 V 3 AC, 400 to 1 200 A, two-quadrant operation

	Type	Type			
		6RA8081-6DS22-0AA0	6RA8085-6DS22-0AA0	6RA8087-6DS22-0AA0	6RA8091-6DS22-0AA0
Rated armature supply voltage ¹⁾	V	400 V 3 AC (+15/-20 %)			
Rated armature input current	A	332	498	706	996
Rated supply voltage, electronics power supply	V	380 (-25 %) ... 480 V (+10 %) 2 AC; $I_n = 1$ A or 190 (-25 %) ... 240 V (+10 %) 2 AC; $I_n = 2$ A			
Rated fan supply voltage	V	400 V 3 AC ± 10 % (50 Hz) 460 V 3 AC ± 10 % (60 Hz)			
Rated fan current	A	0.23 ³⁾			0.3 ³⁾
Air flow	m ³ /h	600			1 000
Sound pressure level ²⁾	dB (A)	64.5			
Rated field supply voltage ¹⁾	V	400 V 2 AC (+15/-20 %)			480 V 2 AC (+10/-20 %)
Rated frequency	Hz	45 ... 65			
Rated DC voltage ¹⁾	V	485			
Rated DC current	A	400	600	850	1 200
Overload capability	$x \times I_n$	1.8			
Rated power	kW	194	291	412	582
Power loss at rated DC current	kW	1.37	1.84	2.47	4.11
Rated DC field voltage ¹⁾	V	max. 325			max. 390
Rated DC field current	A	25			40
Normal ambient temperature in operation ⁴⁾	°C	0 ... +40			
Storage and transport temperature	°C	-40 ... +70			
Installation altitude above sea level ⁴⁾		≤ 1 000 m for rated DC current			
Dimensions					
• Width	mm	268			
• Height	mm	625		700	783
• Depth	mm	275		311	435
Weight, approx.	kg	26	28	38	78

Note:

Detailed dimension drawings in the PDF and DXF formats are available on the DVD-ROM supplied with this catalog and in the Internet under www.siemens.com/sinamics-dcm (information material).

¹⁾ The armature/field supply voltage may be lower than the rated armature/field voltage (set via parameter; in the case of units with a 400 V rated voltage, an input voltage of up to 85 V is permitted). The output voltage decreases accordingly. The specified DC output voltage can be maintained up to an undervoltage of 5 % of the line supply voltage (rated armature/field supply voltage).

²⁾ Fan noise for a unit installed in an IP20 electrical cabinet (door closed, 50 Hz operation or operation at 24 V DC for units with an internal supply).

³⁾ For fan motor type R2D220-AB02-19 in units 6RA8081, 6RA8085, and 6RA8087 with a rated voltage of 400 V or 575 V, UL systems require a Siemens motor circuit-breaker of type 3RV1011-0DA1 or 3RV1011-0EA1, set to 0.3 A.

⁴⁾ Derating factors for higher temperatures and installation altitudes, see page 3/8.

SINAMICS DCM

DC Converter and Control Module

DC Converter

Technical specifications (continued)

SINAMICS DC MASTER converters for 400 V 3 AC, 1 600 to 3 000 A, two-quadrant operation

	Type	6RA8093-4DS22-0AA0			6RA8095-4DS22-0AA0			6RA8098-4DS22-0AA0		
		6RA8093-4DS22-0AA0	6RA8095-4DS22-0AA0	6RA8098-4DS22-0AA0	6RA8093-4DS22-0AA0	6RA8095-4DS22-0AA0	6RA8098-4DS22-0AA0	6RA8093-4DS22-0AA0	6RA8095-4DS22-0AA0	6RA8098-4DS22-0AA0
Rated armature supply voltage ¹⁾	V	400 V 3 AC (+15/-20 %)			400 V 3 AC (+15/-20 %)			400 V 3 AC (+10/-20 %)		
Rated armature input current	A	1 328			1 660			2 490		
Rated supply voltage, electronics power supply	V	380 (-25 %) ... 480 V (+10 %) 2 AC; $I_n = 1$ A or 190 (-25 %) ... 240 V (+10 %) 2 AC; $I_n = 2$ A								
Rated fan supply voltage	V	400 V 3 AC ± 10 % (50 Hz) 460 V 3 AC ± 10 % (60 Hz)								
Rated fan current	A	1 ³⁾								
Air flow	m ³ /h	2 400								
Sound pressure level ²⁾	dB (A)	75.6								
Rated field supply voltage ¹⁾	V	480 V 2 AC (+10/-20 %)								
Rated frequency	Hz	45 ... 65								
Rated DC voltage ¹⁾	V	485								
Rated DC current	A	1 600			2 000			3 000		
Overload capability	$x \times I_n$	1.8								
Rated power	kW	776			970			1 455		
Power loss at rated DC current	kW	5.68			6.78			10.64		
Rated DC field voltage ¹⁾	V	max. 390								
Rated DC field current	A	40								
Normal ambient temperature in operation ⁴⁾	°C	0 ... +40								
Storage and transport temperature	°C	-40 ... +70								
Installation altitude above sea level ⁴⁾		≤ 1 000 m for rated DC current								
Dimensions										
• Width	mm	453								
• Height	mm	883								
• Depth	mm	505								
Weight, approx.	kg	135						165		

Note:

Detailed dimension drawings in the PDF and DXF formats are available on the DVD-ROM supplied with this catalog and in the Internet under www.siemens.com/sinamics-dcm (information material).

¹⁾ The armature/field supply voltage may be lower than the rated armature/field voltage (set via parameter; in the case of units with a 400 V rated voltage, an input voltage of up to 85 V is permitted). The output voltage decreases accordingly. The specified DC output voltage can be maintained up to an undervoltage of 5 % of the line supply voltage (rated armature/field supply voltage).

²⁾ Fan noise for a unit installed in an IP20 electrical cabinet (door closed, 50 Hz operation or operation at 24 V DC for units with an internal supply).

³⁾ For fan motor type RH28M-2DK.3F.1R in units 6RA8090, 6RA8091, 6RA8093, and 6RA8095 with a rated voltage of 400 V or 575 V, UL systems require a Siemens motor circuit-breaker of type 3RV1011-0KA1 or 3RV1011-1AA1, set to 1.25 A.

⁴⁾ Derating factors for higher temperatures and installation altitudes, see page 3/8.

Technical specifications (continued)

SINAMICS DC MASTER converters for 480 V 3 AC, 60 to 280 A, two-quadrant operation

	Type	Type				
		6RA8025-6FS22-0AA0	6RA8028-6FS22-0AA0	6RA8031-6FS22-0AA0	6RA8075-6FS22-0AA0	6RA8078-6FS22-0AA0
Rated armature supply voltage ¹⁾	V	480 V 3 AC (+10/-20 %)				
Rated armature input current	A	50	75	104	174	232
Rated supply voltage, electronics power supply	V	380 (-25 %) ... 480 V (+10 %) 2 AC; $I_n = 1$ A or 190 (-25 %) ... 240 V (+10 %) 2 AC; $I_n = 2$ A				
Rated fan supply voltage	V	Self-ventilated			24 V DC internal	
Rated fan current	A				Internal supply	
Air flow	m ³ /h				300	
Sound pressure level ²⁾	dB (A)				52.4	
Rated field supply voltage ¹⁾	V	480 V 2 AC (+10/-20 %)				
Rated frequency	Hz	45 ... 65				
Rated DC voltage ¹⁾	V	575				
Rated DC current	A	60	90	125	210	280
Overload capability	$x \times I_n$	1.8				
Rated power	kW	35	52	72	121	161
Power loss at rated DC current	kW	0.30	0.38	0.43	0.72	0.81
Rated DC field voltage ¹⁾	V	max. 390				
Rated DC field current	A	10			15	
Normal ambient temperature in operation ³⁾	°C	0 ... +45			0 ... +40	
Storage and transport temperature	°C	-40 ... +70				
Installation altitude above sea level ³⁾		≤ 1 000 m for rated DC current				
Dimensions						
• Width	mm	268				
• Height	mm	385				
• Depth	mm	252				
Weight, approx.	kg	11	14			15

Note:

Detailed dimension drawings in the PDF and DXF formats are available on the DVD-ROM supplied with this catalog and in the Internet under www.siemens.com/sinamics-dcm (information material).

Data for single-phase operation

	Type	Type		
		6RA8025-6FS22-0AA0	6RA8028-6FS22-0AA0	6RA8031-6FS22-0AA0
Rated DC voltage	V	385		
Rated DC current	A	42.0	63.0	87.5

¹⁾ The armature/field supply voltage may be lower than the rated armature/field voltage (set via parameter; in the case of units with a 400 V rated voltage, an input voltage of up to 85 V is permitted). The output voltage decreases accordingly. The specified DC output voltage can be maintained up to an undervoltage of 5 % of the line supply voltage (rated armature/field supply voltage).

²⁾ Fan noise for a unit installed in an IP20 electrical cabinet (door closed, 50 Hz operation or operation at 24 V DC for units with an internal supply).

³⁾ Derating factors for higher temperatures and installation altitudes, see page 3/8.

SINAMICS DCM

DC Converter and Control Module

DC Converter

Technical specifications (continued)

SINAMICS DC MASTER converters for 480 V 3 AC, 450 to 1 200 A, two-quadrant operation

	Type	6RA8082-6FS22-0AA0				6RA8085-6FS22-0AA0				6RA8087-6FS22-0AA0				6RA8091-6FS22-0AA0			
		480 V 3 AC (+10/-20 %)				498				706				996			
Rated armature supply voltage ¹⁾	V	480 V 3 AC (+10/-20 %)															
Rated armature input current	A	374				498				706				996			
Rated supply voltage, electronics power supply	V	380 (-25 %) ... 480 V (+10 %) 2 AC; $I_n = 1$ A or 190 (-25 %) ... 240 V (+10 %) 2 AC; $I_n = 2$ A															
Rated fan supply voltage	V	400 V 3 AC ± 10 % (50 Hz) 460 V 3 AC ± 10 % (60 Hz)															
Rated fan current	A	0.23 ³⁾								0.3 ³⁾							
Air flow	m ³ /h	600								1 000							
Sound pressure level ²⁾	dB (A)	64.5															
Rated field supply voltage ¹⁾	V	480 V 2 AC (+10/-20 %)															
Rated frequency	Hz	45 ... 65															
Rated DC voltage ¹⁾	V	575															
Rated DC current	A	450				600				850				1 200			
Overload capability	$x \times I_n$	1.8															
Rated power	kW	259				345				489				690			
Power loss at rated DC current	kW	1.58				1.91				2.60				4.24			
Rated DC field voltage ¹⁾	V	max. 390															
Rated DC field current	A	25								30							
Normal ambient temperature in operation ⁴⁾	°C	0 ... +40															
Storage and transport temperature	°C	-40 ... +70															
Installation altitude above sea level ⁴⁾		≤ 1 000 m for rated DC current															
Dimensions																	
• Width	mm	268															
• Height	mm	625								700				783			
• Depth	mm	275															
Weight, approx.	kg	28								38				78			

Note:

Detailed dimension drawings in the PDF and DXF formats are available on the DVD-ROM supplied with this catalog and in the Internet under www.siemens.com/sinamics-dcm (information material).

¹⁾ The armature/field supply voltage may be lower than the rated armature/field voltage (set via parameter; in the case of units with a 400 V rated voltage, an input voltage of up to 85 V is permitted). The output voltage decreases accordingly. The specified DC output voltage can be maintained up to an undervoltage of 5 % of the line supply voltage (rated armature/field supply voltage).

²⁾ Fan noise for a unit installed in an IP20 electrical cabinet (door closed, 50 Hz operation or operation at 24 V DC for units with an internal supply).

³⁾ For fan motor type R2D220-AB02-19 in units 6RA8081, 6RA8085, and 6RA8087 with a rated voltage of 400 V or 575 V, UL systems require a Siemens motor circuit-breaker of type 3RV1011-0DA1 or 3RV1011-0EA1, set to 0.3 A.

⁴⁾ Derating factors for higher temperatures and installation altitudes, see page 3/8.

Technical specifications (continued)

SINAMICS DC MASTER converters for 575 V 3 AC, 60 to 800 A, two-quadrant operation

	Type	Type					
		6RA8025-6GS22-0AA0	6RA8031-6GS22-0AA0	6RA8075-6GS22-0AA0	6RA8081-6GS22-0AA0	6RA8085-6GS22-0AA0	6RA8087-6GS22-0AA0
Rated armature supply voltage ¹⁾	V	575 V 3 AC (+10/-20 %)					
Rated armature input current	A	50	104	174	332	498	664
Rated supply voltage, electronics power supply	V	380 (-25 %) ... 480 V (+10 %) 2 AC; $I_n = 1$ A or 190 (-25 %) ... 240 V (+10 %) 2 AC; $I_n = 2$ A					
Rated fan supply voltage	V	Self-ventilated		24 V DC internal	400 V 3 AC ± 10 % (50 Hz) 460 V 3 AC ± 10 % (60 Hz)		
Rated fan current	A			Internal supply	0.23 ³⁾		
Air flow	m ³ /h			300	600		
Sound pressure level ²⁾	dB (A)			52.4	64.5		
Rated field supply voltage ¹⁾	V	480 V 2 AC (+10/-20 %)					
Rated frequency	Hz	45 ... 65					
Rated DC voltage ¹⁾	V	690					
Rated DC current	A	60	125	210	400	600	800
Overload capability	$x \times I_n$	1.8					
Rated power	kW	41	86	145	276	414	552
Power loss at rated DC current	kW	0.27	0.46	0.74	1.60	2.00	2.69
Rated DC field voltage ¹⁾	V	max. 390					
Rated DC field current	A	10	15		25	30	
Normal ambient temperature in operation ⁴⁾	°C	0 ... +45		0 ... +40			
Storage and transport temperature	°C	-40 ... +70					
Installation altitude above sea level ⁴⁾		≤ 1 000 m for rated DC current					
Dimensions							
• Width	mm	268					
• Height	mm	385			625		700
• Depth	mm	252			275		311
Weight, approx.	kg	11	14		26	28	38

Note:

Detailed dimension drawings in the PDF and DXF formats are available on the DVD-ROM supplied with this catalog and in the Internet under www.siemens.com/sinamics-dcm (information material).

Data for single-phase operation

	Type	Type	
		6RA8025-6GS22-0AA0	6RA8031-6GS22-0AA0
Rated DC voltage	V	460	
Rated DC current	A	42.0	87.5

¹⁾ The armature/field supply voltage may be lower than the rated armature/field voltage (set via parameter; in the case of units with a 400 V rated voltage, an input voltage of up to 85 V is permitted). The output voltage decreases accordingly. The specified DC output voltage can be maintained up to an undervoltage of 5 % of the line supply voltage (rated armature/field supply voltage).

²⁾ Fan noise for a unit installed in an IP20 electrical cabinet (door closed, 50 Hz operation or operation at 24 V DC for units with an internal supply).

³⁾ For fan motor type R2D220-AB02-19 in units 6RA8081, 6RA8085, and 6RA8087 with a rated voltage of 400 V or 575 V, UL systems require a Siemens motor circuit-breaker of type 3RV1011-0DA1 or 3RV1011-0EA1, set to 0.3 A.

⁴⁾ Derating factors for higher temperatures and installation altitudes, see page 3/8.

SINAMICS DCM

DC Converter and Control Module

DC Converter

Technical specifications (continued)

SINAMICS DC MASTER converters for 575 V 3 AC, 1 100 to 2 800 A, two-quadrant operation

	Type	6RA8090-6GS22-0AA0				
		6RA8093-4GS22-0AA0	6RA8095-4GS22-0AA0	6RA8096-4GS22-0AA0	6RA8097-4GS22-0AA0	
Rated armature supply voltage ¹⁾	V	575 V 3 AC (+10/-20 %)				
Rated armature input current	A	913	1 328	1 660	1 826	2 324
Rated supply voltage, electronics power supply	V	380 (-25 %) ... 480 V (+10 %) 2 AC; $I_n = 1$ A or 190 (-25 %) ... 240 V (+10 %) 2 AC; $I_n = 2$ A				
Rated fan supply voltage	V	400 V 3 AC ± 10 % (50 Hz) 460 V 3 AC ± 10 % (60 Hz)				
Rated fan current	A	0.3 ³⁾	1 ⁴⁾			
Air flow	m ³ /h	1 000	2 400			
Sound pressure level ²⁾	dB (A)	64.5	75.6			
Rated field supply voltage ¹⁾	V	480 V 2 AC (+10/-20 %)				
Rated frequency	Hz	45 ... 65				
Rated DC voltage ¹⁾	V	690				
Rated DC current	A	1 100	1 600	2 000	2 200	2 800
Overload capability	$x \times I_n$	1.8				
Rated power	kW	759	1 104	1 380	1 518	1 932
Power loss at rated DC current	kW	4.02	6.04	7.07	7.39	10.53
Rated DC field voltage ¹⁾	V	max. 390				
Rated DC field current	A	40				
Normal ambient temperature in operation ⁵⁾	°C	0 ... +40				
Storage and transport temperature	°C	-40 ... +70				
Installation altitude above sea level ⁵⁾		≤ 1 000 m for rated DC current				
Dimensions						
• Width	mm	268	453			
• Height	mm	785	883			
• Depth	mm	435	505			
Weight, approx.	kg	78	135		165	

Note:

Detailed dimension drawings in the PDF and DXF formats are available on the DVD-ROM supplied with this catalog and in the Internet under www.siemens.com/sinamics-dcm (information material).

¹⁾ The armature/field supply voltage may be lower than the rated armature/field voltage (set via parameter; in the case of units with a 400 V rated voltage, an input voltage of up to 85 V is permitted). The output voltage decreases accordingly. The specified DC output voltage can be maintained up to an undervoltage of 5 % of the line supply voltage (rated armature/field supply voltage).

²⁾ Fan noise for a unit installed in an IP20 electrical cabinet (door closed, 50 Hz operation or operation at 24 V DC for units with an internal supply).

³⁾ For fan motor type R2D220-AB02-19 in units 6RA8081, 6RA8085, and 6RA8087 with a rated voltage of 400 V or 575 V, UL systems require a Siemens motor circuit-breaker of type 3RV1011-0DA1 or 3RV1011-0EA1, set to 0.3 A.

⁴⁾ For fan motor type RH28M-2DK.3F.1R in units 6RA8090, 6RA8091, 6RA8093, and 6RA8095 with a rated voltage of 400 V or 575 V, UL systems require a Siemens motor circuit-breaker of type 3RV1011-0KA1 or 3RV1011-1AA1, set to 1.25 A.

⁵⁾ Derating factors for higher temperatures and installation altitudes, see page 3/8.

Technical specifications (continued)

SINAMICS DC MASTER converters for 690 V 3 AC, 720 to 2 600 A, two-quadrant operation

	Type	Type				
		6RA8086-6KS22-0AA0	6RA8090-6KS22-0AA0	6RA8093-4KS22-0AA0	6RA8095-4KS22-0AA0	6RA8097-4KS22-0AA0
Rated armature supply voltage ¹⁾	V	690 V 3 AC (+10/-20 %)				
Rated armature input current	A	598	830	1 245	1 660	2 158
Rated supply voltage, electronics power supply	V	380 (-25 %) ... 480 V (+10 %) 2 AC; $I_n = 1$ A or 190 (-25 %) ... 240 V (+10 %) 2 AC; $I_n = 2$ A				
Rated fan supply voltage	V	400 V 3 AC ± 10 % (50 Hz) 460 V 3 AC ± 10 % (60 Hz)				
Rated fan current	A	0.23 ³⁾	0.3 ³⁾	1 ⁴⁾		
Air flow	m ³ /h	600	1 000	2 400		
Sound pressure level ²⁾	dB (A)	64.5			75.6	
Rated field supply voltage ¹⁾	V	480 V 2 AC (+10/-20 %)				
Rated frequency	Hz	45 ... 65				
Rated DC voltage ¹⁾	V	830				
Rated DC current	A	720	1 000	1 500	2 000	2 600
Overload capability	$x \times I_n$	1.8				
Rated power	kW	598	830	1 245	1 660	2 158
Power loss at rated DC current	kW	2.77	3.96	6.67	8.16	10.30
Rated DC field voltage ¹⁾	V	max. 390				
Rated DC field current	A	30	40			
Normal ambient temperature in operation ⁵⁾	°C	0 ... +40				
Storage and transport temperature	°C	-40 ... +70				
Installation altitude above sea level ⁵⁾		≤ 1 000 m for rated DC current				
Dimensions						
• Width	mm	268		453		
• Height	mm	700	785	883		
• Depth	mm	311	435	505		
Weight, approx.	kg	38	78	135		165

Note:

Detailed dimension drawings in the PDF and DXF formats are available on the DVD-ROM supplied with this catalog and in the Internet under www.siemens.com/sinamics-dcm (information material).

¹⁾ The armature/field supply voltage may be lower than the rated armature/field voltage (set via parameter; in the case of units with a 400 V rated voltage, an input voltage of up to 85 V is permitted). The output voltage decreases accordingly. The specified DC output voltage can be maintained up to an undervoltage of 5 % of the line supply voltage (rated armature/field supply voltage).

²⁾ Fan noise for a unit installed in an IP20 electrical cabinet (door closed, 50 Hz operation or operation at 24 V DC for units with an internal supply).

³⁾ For fan motor type R2D220-AB02-19 in units 6RA8081, 6RA8085, and 6RA8087 with a rated voltage of 400 V or 575 V, UL systems require a Siemens motor circuit-breaker of type 3RV1011-0DA1 or 3RV1011-0EA1, set to 0.3 A.

⁴⁾ For fan motor type RH28M-2DK.3F.1R in units 6RA8090, 6RA8091, 6RA8093, and 6RA8095 with a rated voltage of 400 V or 575 V, UL systems require a Siemens motor circuit-breaker of type 3RV1011-0KA1 or 3RV1011-1AA1, set to 1.25 A.

⁵⁾ Derating factors for higher temperatures and installation altitudes, see page 3/8.

SINAMICS DCM

DC Converter and Control Module

DC Converter

Technical specifications (continued)

SINAMICS DC MASTER converters for 830 V 3 AC, 950 to 1 900 A and 950 V 3 AC, 2 200 A, two-quadrant operation

	Type	Type			
		6RA8088-6LS22-0AA0	6RA8093-4LS22-0AA0	6RA8095-4LS22-0AA0	6RA8096-4MS22-0AA0
Rated armature supply voltage ¹⁾	V	830 V 3 AC (+10/-20 %)			950 V 3 AC (+15/-20 %)
Rated armature input current	A	789	1 245	1 577	1 826
Rated supply voltage, electronics power supply	V	380 (-25 %) ... 480 V (+10 %) 2 AC; $I_n = 1$ A or 190 (-25 %) ... 240 V (+10 %) 2 AC; $I_n = 2$ A			
Rated fan supply voltage	V	400 V 3 AC ± 10 % (50 Hz) 460 V 3 AC ± 10 % (60 Hz)			
Rated fan current	A	0.3 ³⁾	1 ⁴⁾		
Air flow	m ³ /h	1 000	2 400		
Sound pressure level ²⁾	dB (A)	64.5	75.6		
Rated field supply voltage ¹⁾	V	480 V 2 AC (+10/-20 %)			
Rated frequency	Hz	45 ... 65			
Rated DC voltage ¹⁾	V	1 000			1 140
Rated DC current	A	950	1 500	1 900	2 200
Overload capability	$x \times I_n$	1.8			
Rated power	kW	950	1 500	1 900	2 508
Power loss at rated DC current	kW	4.22	7.12	8.67	11.34
Rated DC field voltage ¹⁾	V	max. 390			
Rated DC field current	A	40			
Normal ambient temperature in operation ⁵⁾	°C	0 ... +40			
Storage and transport temperature	°C	-40 ... +70			
Installation altitude above sea level ⁵⁾		≤ 1 000 m for rated DC current			
Dimensions					
• Width	mm	268	453		
• Height	mm	785	883		
• Depth	mm	435	505		
Weight, approx.	kg	78	135		165

Note:

Detailed dimension drawings in the PDF and DXF formats are available on the DVD-ROM supplied with this catalog and in the Internet under www.siemens.com/sinamics-dcm (information material).

¹⁾ The armature/field supply voltage may be lower than the rated armature/field voltage (set via parameter; in the case of units with a 400 V rated voltage, an input voltage of up to 85 V is permitted). The output voltage decreases accordingly. The specified DC output voltage can be maintained up to an undervoltage of 5 % of the line supply voltage (rated armature/field supply voltage).

²⁾ Fan noise for a unit installed in an IP20 electrical cabinet (door closed, 50 Hz operation or operation at 24 V DC for units with an internal supply).

³⁾ For fan motor type R2D220-AB02-19 in units 6RA8081, 6RA8085, and 6RA8087 with a rated voltage of 400 V or 575 V, UL systems require a Siemens motor circuit-breaker of type 3RV1011-0DA1 or 3RV1011-0EA1, set to 0.3 A.

⁴⁾ For fan motor type RH28M-2DK.3F.1R in units 6RA8090, 6RA8091, 6RA8093, and 6RA8095 with a rated voltage of 400 V or 575 V, UL systems require a Siemens motor circuit-breaker of type 3RV1011-0KA1 or 3RV1011-1AA1, set to 1.25 A.

⁵⁾ Derating factors for higher temperatures and installation altitudes, see page 3/8.

Technical specifications (continued)

SINAMICS DC MASTER converters for 400 V 3 AC, 15 to 125 A, four-quadrant operation

		Type				
		6RA8013-6DV62-0AA0	6RA8018-6DV62-0AA0	6RA8025-6DV62-0AA0	6RA8028-6DV62-0AA0	6RA8031-6DV62-0AA0
Rated armature supply voltage ¹⁾	V	400 V 3 AC (+15/-20 %)				
Rated armature input current	A	12	25	50	75	104
Rated supply voltage, electronics power supply	V	380 (-25 %) ... 480 V (+10 %) 2 AC; $I_n = 1$ A or 190 (-25 %) ... 240 V (+10 %) 2 AC; $I_n = 2$ A				
Rated fan supply voltage	V	Self-ventilated				
Rated fan current	A					
Air flow	m ³ /h					
Sound pressure level ²⁾	dB (A)					
Rated field supply voltage ¹⁾	V	400 V 2 AC (+15/-20 %)				
Rated frequency	Hz	45 ... 65				
Rated DC voltage ¹⁾	V	420				
Rated DC current	A	15	30	60	90	125
Overload capability	$x \times I_n$	1.8				
Rated power	kW	6.3	12.6	25	38	53
Power loss at rated DC current	kW	0.13	0.18	0.25	0.32	0.41
Rated DC field voltage ¹⁾	V	max. 325				
Rated DC field current	A	3	5	10		
Normal ambient temperature in operation ³⁾	°C	0 ... +45				
Storage and transport temperature	°C	-40 ... +70				
Installation altitude above sea level ³⁾		≤ 1 000 m for rated DC current				
Dimensions						
• Width	mm	268				
• Height	mm	385				
• Depth	mm	221		252		
Weight, approx.	kg	11			14	

Note:

Detailed dimension drawings in the PDF and DXF formats are available on the DVD-ROM supplied with this catalog and in the Internet under www.siemens.com/sinamics-dcm (information material).

Data for single-phase operation

		Type				
		6RA8013-6DV62-0AA0	6RA8018-6DV62-0AA0	6RA8025-6DV62-0AA0	6RA8028-6DV62-0AA0	6RA8031-6DV62-0AA0
Rated DC voltage	V	280				
Rated DC current	A	10.5	21.0	42.0	63.0	87.5

¹⁾ The armature/field supply voltage may be lower than the rated armature/field voltage (set via parameter; in the case of units with a 400 V rated voltage, an input voltage of up to 85 V is permitted). The output voltage decreases accordingly. The specified DC output voltage can be maintained up to an undervoltage of 5 % of the line supply voltage (rated armature/field supply voltage).

²⁾ Fan noise for a unit installed in an IP20 electrical cabinet (door closed, 50 Hz operation or operation at 24 V DC for units with an internal supply).

³⁾ Derating factors for higher temperatures and installation altitudes, see page 3/8.

SINAMICS DCM

DC Converter and Control Module

DC Converter

Technical specifications (continued)

SINAMICS DC MASTER converters for 400 V 3 AC, 210 to 850 A, four-quadrant operation

	Type	Type				
		6RA8075-6DV62-0AA0	6RA8078-6DV62-0AA0	6RA8081-6DV62-0AA0	6RA8085-6DV62-0AA0	6RA8087-6DV62-0AA0
Rated armature supply voltage ¹⁾	V	400 V 3 AC (+15/-20 %)				
Rated armature input current	A	174	232	332	498	706
Rated supply voltage, electronics power supply	V	380 (-25 %) ... 480 V (+10 %) 2 AC; $I_n = 1$ A or 190 (-25 %) ... 240 V (+10 %) 2 AC; $I_n = 2$ A				
Rated fan supply voltage	V	24 V DC internal		400 V 3 AC ± 10 % (50 Hz) 460 V 3 AC ± 10 % (60 Hz)		
Rated fan current	A	Internal supply		0.23 ³⁾		
Air flow	m ³ /h	300		600		
Sound pressure level ²⁾	dB (A)	52.4		64.5		
Rated field supply voltage ¹⁾	V	400 V 2 AC (+15/-20 %)				
Rated frequency	Hz	45 ... 65				
Rated DC voltage ¹⁾	V	420				
Rated DC current	A	210	280	400	600	850
Overload capability	$x \times I_n$	1.8				
Rated power	kW	88	118	168	252	357
Power loss at rated DC current	kW	0.69	0.81	1.37	1.84	2.47
Rated DC field voltage ¹⁾	V	max. 325				
Rated DC field current	A	15		25		30
Normal ambient temperature in operation ⁴⁾	°C	0 ... +40				
Storage and transport temperature	°C	-40 ... +70				
Installation altitude above sea level ⁴⁾		≤ 1 000 m for rated DC current				
Dimensions						
• Width	mm	268				
• Height	mm	385		625		700
• Depth	mm	252		275		311
Weight, approx.	kg	15		26		31
				31		42

Note:

Detailed dimension drawings in the PDF and DXF formats are available on the DVD-ROM supplied with this catalog and in the Internet under www.siemens.com/sinamics-dcm (information material).

¹⁾ The armature/field supply voltage may be lower than the rated armature/field voltage (set via parameter; in the case of units with a 400 V rated voltage, an input voltage of up to 85 V is permitted). The output voltage decreases accordingly. The specified DC output voltage can be maintained up to an undervoltage of 5 % of the line supply voltage (rated armature/field supply voltage).

²⁾ Fan noise for a unit installed in an IP20 electrical cabinet (door closed, 50 Hz operation or operation at 24 V DC for units with an internal supply).

³⁾ For fan motor type R2D220-AB02-19 in units 6RA8081, 6RA8085, and 6RA8087 with a rated voltage of 400 V or 575 V, UL systems require a Siemens motor circuit-breaker of type 3RV1011-0DA1 or 3RV1011-0EA1, set to 0.3 A.

⁴⁾ Derating factors for higher temperatures and installation altitudes, see page 3/8.

Technical specifications (continued)

SINAMICS DC MASTER converters for 400 V 3 AC, 1 200 to 3 000 A, four-quadrant operation

	Type	Type			
		6RA8091-6DV62-0AA0	6RA8093-4DV62-0AA0	6RA8095-4DV62-0AA0	6RA8098-4DV62-0AA0
Rated armature supply voltage ¹⁾	V	400 V 3 AC (+15/-20 %)			400 V 3 AC (+10/-20 %)
Rated armature input current	A	996	1 328	1 660	2 490
Rated supply voltage, electronics power supply	V	380 (-25 %) ... 480 V (+10 %) 2 AC; $I_n = 1$ A or 190 (-25 %) ... 240 V (+10 %) 2 AC; $I_n = 2$ A			
Rated fan supply voltage	V	400 V 3 AC ± 10 % (50 Hz) 460 V 3 AC ± 10 % (60 Hz)			
Rated fan current	A	0.3 ³⁾	1 ⁴⁾		
Air flow	m ³ /h	1 000	2 400		
Sound pressure level ²⁾	dB (A)	64.5	75.6		
Rated field supply voltage ¹⁾	V	480 V 2 AC (+10/-20 %)			
Rated frequency	Hz	45 ... 65			
Rated DC voltage ¹⁾	V	420			
Rated DC current	A	1 200	1 600	2 000	3 000
Overload capability	$x \times I_n$	1.8			
Rated power	kW	504	672	840	1 260
Power loss at rated DC current	kW	4.11	5.68	6.78	10.64
Rated DC field voltage ¹⁾	V	max. 390			
Rated DC field current	A	40			
Normal ambient temperature in operation ⁴⁾	°C	0 ... +40			
Storage and transport temperature	°C	-40 ... +70			
Installation altitude above sea level ⁴⁾		≤ 1 000 m for rated DC current			
Dimensions					
• Width	mm	268	453		
• Height	mm	785	883		
• Depth	mm	435	505		
Weight, approx.	kg	78	155		185

Note:

Detailed dimension drawings in the PDF and DXF formats are available on the DVD-ROM supplied with this catalog and in the Internet under www.siemens.com/sinamics-dcm (information material).

¹⁾ The armature/field supply voltage may be lower than the rated armature/field voltage (set via parameter; in the case of units with a 400 V rated voltage, an input voltage of up to 85 V is permitted). The output voltage decreases accordingly. The specified DC output voltage can be maintained up to an undervoltage of 5 % of the line supply voltage (rated armature/field supply voltage).

²⁾ Fan noise for a unit installed in an IP20 electrical cabinet (door closed, 50 Hz operation or operation at 24 V DC for units with an internal supply).

³⁾ For fan motor type R2D220-AB02-19 in units 6RA8081, 6RA8085, and 6RA8087 with a rated voltage of 400 V or 575 V, UL systems require a Siemens motor circuit-breaker of type 3RV1011-0DA1 or 3RV1011-0EA1, set to 0.3 A.

⁴⁾ Derating factors for higher temperatures and installation altitudes, see page 3/8.

SINAMICS DCM

DC Converter and Control Module

DC Converter

Technical specifications (continued)

SINAMICS DC MASTER converters for 480 V 3 AC, 15 to 210 A, four-quadrant operation

	Type	Type						
		6RA8013-6FV62-0AA0	6RA8018-6FV62-0AA0	6RA8025-6FV62-0AA0	6RA8028-6FV62-0AA0	6RA8031-6FV62-0AA0	6RA8075-6FV62-0AA0	
Rated armature supply voltage ¹⁾	V	480 V 3 AC (+15/-20 %)		480 V 3 AC (+10/-20 %)				
Rated armature input current	A	12	25	50	75	104	174	
Rated supply voltage, electronics power supply	V	380 (-25 %) ... 480 V (+10 %) 2 AC; $I_n = 1$ A or 190 (-25 %) ... 240 V (+10 %) 2 AC; $I_n = 2$ A						
Rated fan supply voltage	V	Self-ventilated						24 V DC internal
Rated fan current	A							Internal supply
Air flow	m ³ /h							300
Sound pressure level ²⁾	dB (A)							52.4
Rated field supply voltage ¹⁾	V	480 V 2 AC (+10/-20 %)						
Rated frequency	Hz	45 ... 65						
Rated DC voltage ¹⁾	V	500						
Rated DC current	A	15	30	60	90	125	210	
Overload capability	$x \times I_n$	1.8						
Rated power	kW	6	15	30	45	63	105	
Power loss at rated DC current	kW	0.13	0.19	0.30	0.34	0.43	0.72	
Rated DC field voltage ¹⁾	V	max. 390						
Rated DC field current	A	3	5	10	10	10	15	
Normal ambient temperature in operation ³⁾	°C	0 ... +45						0 ... +40
Storage and transport temperature	°C	-40 ... +70						
Installation altitude above sea level ³⁾		≤ 1 000 m for rated DC current						
Dimensions								
• Width	mm	268						
• Height	mm	385						
• Depth	mm	221		252				
Weight, approx.	kg	11			14		15	

Note:

Detailed dimension drawings in the PDF and DXF formats are available on the DVD-ROM supplied with this catalog and in the Internet under www.siemens.com/sinamics-dcm (information material).

Data for single-phase operation

	Type	Type				
		6RA8013-6FV62-0AA0	6RA8018-6FV62-0AA0	6RA8025-6FV62-0AA0	6RA8028-6FV62-0AA0	6RA8031-6FV62-0AA0
Rated DC voltage	V	335				
Rated DC current	A	10.5	21.0	42.0	63.0	87.5

¹⁾ The armature/field supply voltage may be lower than the rated armature/field voltage (set via parameter; in the case of units with a 400 V rated voltage, an input voltage of up to 85 V is permitted). The output voltage decreases accordingly. The specified DC output voltage can be maintained up to an undervoltage of 5 % of the line supply voltage (rated armature/field supply voltage).

²⁾ Fan noise for a unit installed in an IP20 electrical cabinet (door closed, 50 Hz operation or operation at 24 V DC for units with an internal supply).

³⁾ Derating factors for higher temperatures and installation altitudes, see page 3/8.

Technical specifications (continued)

SINAMICS DC MASTER converters for 480 V 3 AC, 280 to 1 200 A, four-quadrant operation

	Type	Type				
		6RA8078-6FV62-0AA0	6RA8082-6FV62-0AA0	6RA8085-6FV62-0AA0	6RA8087-6FV62-0AA0	6RA8091-6FV62-0AA0
Rated armature supply voltage ¹⁾	V	480 V 3 AC (+10/-20 %)				
Rated armature input current	A	232	374	498	706	996
Rated supply voltage, electronics power supply	V	380 (-25 %) ... 480 V (+10 %) 2 AC; $I_n = 1$ A or 190 (-25 %) ... 240 V (+10 %) 2 AC; $I_n = 2$ A				
Rated fan supply voltage	V	24 V DC internal	400 V 3 AC ± 10 % (50 Hz) 460 V 3 AC ± 10 % (60 Hz)			
Rated fan current	A	Internal supply	0.23 ³⁾		0.3 ³⁾	
Air flow	m ³ /h	300	600		1 000	
Sound pressure level ²⁾	dB (A)	52.4	64.5			
Rated field supply voltage ¹⁾	V	480 V 2 AC (+10/-20 %)				
Rated frequency	Hz	45 ... 65				
Rated DC voltage ¹⁾	V	500				
Rated DC current	A	280	450	600	850	1 200
Overload capability	$x \times I_n$	1.8				
Rated power	kW	140	225	300	425	600
Power loss at rated DC current	kW	0.81	1.58	1.91	2.60	4.24
Rated DC field voltage ¹⁾	V	max. 390				
Rated DC field current	A	15	25	25	30	40
Normal ambient temperature in operation ⁴⁾	°C	0 ... +40				
Storage and transport temperature	°C	-40 ... +70				
Installation altitude above sea level ⁴⁾		$\leq 1\ 000$ m for rated DC current				
Dimensions						
• Width	mm	268				
• Height	mm	385	625		700	785
• Depth	mm	252	275		311	435
Weight, approx.	kg	15	31		42	78

Note:

Detailed dimension drawings in the PDF and DXF formats are available on the DVD-ROM supplied with this catalog and in the Internet under www.siemens.com/sinamics-dcm (information material).

¹⁾ The armature/field supply voltage may be lower than the rated armature/field voltage (set via parameter; in the case of units with a 400 V rated voltage, an input voltage of up to 85 V is permitted). The output voltage decreases accordingly. The specified DC output voltage can be maintained up to an undervoltage of 5 % of the line supply voltage (rated armature/field supply voltage).

²⁾ Fan noise for a unit installed in an IP20 electrical cabinet (door closed, 50 Hz operation or operation at 24 V DC for units with an internal supply).

³⁾ For fan motor type R2D220-AB02-19 in units 6RA8081, 6RA8085, and 6RA8087 with a rated voltage of 400 V or 575 V, UL systems require a Siemens motor circuit-breaker of type 3RV1011-0DA1 or 3RV1011-0EA1, set to 0.3 A.

⁴⁾ Derating factors for higher temperatures and installation altitudes, see page 3/8.

SINAMICS DCM

DC Converter and Control Module

DC Converter

Technical specifications (continued)

SINAMICS DC MASTER converters for 575 V 3 AC, 60 to 850 A, four-quadrant operation

	Type	Type					
		6RA8025-6GV62-0AA0	6RA8031-6GV62-0AA0	6RA8075-6GV62-0AA0	6RA8081-6GV62-0AA0	6RA8085-6GV62-0AA0	6RA8087-6GV62-0AA0
Rated armature supply voltage ¹⁾	V	575 V 3 AC (+10/-20 %)					
Rated armature input current	A	50	104	174	332	498	706
Rated supply voltage, electronics power supply	V	380 (-25 %) ... 480 V (+10 %) 2 AC; $I_n = 1$ A or 190 (-25 %) ... 240 V (+10 %) 2 AC; $I_n = 2$ A					
Rated fan supply voltage	V	Self-ventilated		24 V DC internal	400 V 3 AC ± 10 % (50 Hz) 460 V 3 AC ± 10 % (60 Hz)		
Rated fan current	A			Internal supply	0.23 ³⁾		
Air flow	m ³ /h			300	600		
Sound pressure level ²⁾	dB (A)			52.4	64.5		
Rated field supply voltage ¹⁾	V	480 V 2 AC (+10/-20 %)					
Rated frequency	Hz	45 ... 65					
Rated DC voltage ¹⁾	V	600					
Rated DC current	A	60	125	210	400	600	850
Overload capability	$x \times I_n$	1.8					
Rated power	kW	36	75	126	240	360	510
Power loss at rated DC current	kW	0.27	0.46	0.74	1.60	2.00	2.83
Rated DC field voltage ¹⁾	V	max. 390					
Rated DC field current	A	10	10	15	25	25	30
Normal ambient temperature in operation ⁴⁾	°C	0 ... +45		0 ... +40			
Storage and transport temperature	°C	-40 ... +70					
Installation altitude above sea level ⁴⁾		≤ 1 000 m for rated DC current					
Dimensions							
• Width	mm	268					
• Height	mm	385			65		700
• Depth	mm	252			275		311
Weight, approx.	kg	11	14	15	26	31	42

Note:

Detailed dimension drawings in the PDF and DXF formats are available on the DVD-ROM supplied with this catalog and in the Internet under www.siemens.com/sinamics-dcm (information material).

Data for single-phase operation

	Type	Type	
		6RA8025-6GV62-0AA0	6RA8031-6GV62-0AA0
Rated DC voltage	V	400	
Rated DC current	A	42.0	87.5

¹⁾ The armature/field supply voltage may be lower than the rated armature/field voltage (set via parameter; in the case of units with a 400 V rated voltage, an input voltage of up to 85 V is permitted). The output voltage decreases accordingly. The specified DC output voltage can be maintained up to an undervoltage of 5 % of the line supply voltage (rated armature/field supply voltage).

²⁾ Fan noise for a unit installed in an IP20 electrical cabinet (door closed, 50 Hz operation or operation at 24 V DC for units with an internal supply).

³⁾ For fan motor type R2D220-AB02-19 in units 6RA8081, 6RA8085, and 6RA8087 with a rated voltage of 400 V or 575 V, UL systems require a Siemens motor circuit-breaker of type 3RV1011-0DA1 or 3RV1011-0EA1, set to 0.3 A.

⁴⁾ Derating factors for higher temperatures and installation altitudes, see page 3/8.

Technical specifications (continued)

SINAMICS DC MASTER converters for 575 V 3 AC, 1 100 to 2 800 A, four-quadrant operation

	Type	Type				
		6RA8090-6GV62-0AA0	6RA8093-4GV62-0AA0	6RA8095-4GV62-0AA0	6RA8096-4GV62-0AA0	6RA8097-4GV62-0AA0
Rated armature supply voltage ¹⁾	V	575 V 3 AC (+10/-20 %)				
Rated armature input current	A	913	1 328	1 660	1 826	2 324
Rated supply voltage, electronics power supply	V	380 (-25 %) ... 480 V (+10 %) 2 AC; $I_n = 1$ A or 190 (-25 %) ... 240 V (+10 %) 2 AC; $I_n = 2$ A				
Rated fan supply voltage	V	400 V 3 AC ± 10 % (50 Hz) 460 V 3 AC ± 10 % (60 Hz)				
Rated fan current	A	0.3 ³⁾	1 ⁴⁾			
Air flow	m ³ /h	1 000	2 400			
Sound pressure level ²⁾	dB (A)	64.5	75.6			
Rated field supply voltage ¹⁾	V	480 V 2 AC (+10/-20 %)				
Rated frequency	Hz	45 ... 65				
Rated DC voltage ¹⁾	V	600				
Rated DC current	A	1 100	1 600	2 000	2 200	2 800
Overload capability	$x \times I_n$	1.8				
Rated power	kW	660	960	1 200	1 320	1 680
Power loss at rated DC current	kW	4.02	6.04	7.07	7.39	10.53
Rated DC field voltage ¹⁾	V	max. 390				
Rated DC field current	A	40				
Normal ambient temperature in operation ⁵⁾	°C	0 ... +40				
Storage and transport temperature	°C	-40 ... +70				
Installation altitude above sea level ⁵⁾		≤ 1 000 m for rated DC current				
Dimensions						
• Width	mm	268	453			
• Height	mm	785	883			
• Depth	mm	435	505			
Weight, approx.	kg	78	155		185	

Note:

Detailed dimension drawings in the PDF and DXF formats are available on the DVD-ROM supplied with this catalog and in the Internet under www.siemens.com/sinamics-dcm (information material).

¹⁾ The armature/field supply voltage may be lower than the rated armature/field voltage (set via parameter; in the case of units with a 400 V rated voltage, an input voltage of up to 85 V is permitted). The output voltage decreases accordingly. The specified DC output voltage can be maintained up to an undervoltage of 5 % of the line supply voltage (rated armature/field supply voltage).

²⁾ Fan noise for a unit installed in an IP20 electrical cabinet (door closed, 50 Hz operation or operation at 24 V DC for units with an internal supply).

³⁾ For fan motor type R2D220-AB02-19 in units 6RA8081, 6RA8085, and 6RA8087 with a rated voltage of 400 V or 575 V, UL systems require a Siemens motor circuit-breaker of type 3RV1011-0DA1 or 3RV1011-0EA1, set to 0.3 A.

⁴⁾ For fan motor type RH28M-2DK.3F.1R in units 6RA8090, 6RA8091, 6RA8093, and 6RA8095 with a rated voltage of 400 V or 575 V, UL systems require a Siemens motor circuit-breaker of type 3RV1011-0KA1 or 3RV1011-1AA1, set to 1.25 A.

⁵⁾ Derating factors for higher temperatures and installation altitudes, see page 3/8.

SINAMICS DCM

DC Converter and Control Module

DC Converter

Technical specifications (continued)

SINAMICS DC MASTER converters for 690 V 3 AC, 760 to 2 600 A, four-quadrant operation

	Type	Type				
		6RA8086-6KV62-0AA0	6RA8090-6KV62-0AA0	6RA8093-4KV62-0AA0	6RA8095-4KV62-0AA0	6RA8097-4KV62-0AA0
Rated armature supply voltage ¹⁾	V	690 V 3 AC (+10/-20 %)				
Rated armature input current	A	631	830	1 245	1 660	2 158
Rated supply voltage, electronics power supply	V	380 (-25 %) ... 480 V (+10 %) 2 AC; $I_n = 1$ A or 190 (-25 %) ... 240 V (+10 %) 2 AC; $I_n = 2$ A				
Rated fan supply voltage	V	400 V 3 AC \pm 10 % (50 Hz) 460 V 3 AC \pm 10 % (60 Hz)				
Rated fan current	A	0.23 ³⁾	0.3 ³⁾	1 ⁴⁾		
Air flow	m ³ /h	600	1 000	2 400		
Sound pressure level ²⁾	dB (A)	64.5			75.6	
Rated field supply voltage ¹⁾	V	480 V 2 AC (+10/-20 %)				
Rated frequency	Hz	45 ... 65				
Rated DC voltage ¹⁾	V	725				
Rated DC current	A	760	1 000	1 500	2 000	2 600
Overload capability	$x \times I_n$	1.8				
Rated power	kW	551	725	1 088	1 450	1 885
Power loss at rated DC current	kW	2.90	3.96	6.67	8.16	10.30
Rated DC field voltage ¹⁾	V	max. 390				
Rated DC field current	A	30	40			
Normal ambient temperature in operation ⁵⁾	°C	0 ... +40				
Storage and transport temperature	°C	-40 ... +70				
Installation altitude above sea level ⁵⁾		\leq 1 000 m for rated DC current				
Dimensions						
• Width	mm	268		453		
• Height	mm	700	785	883		
• Depth	mm	311	435	505		
Weight, approx.	kg	42	78	155		185

Note:

Detailed dimension drawings in the PDF and DXF formats are available on the DVD-ROM supplied with this catalog and in the Internet under www.siemens.com/sinamics-dcm (information material).

¹⁾ The armature/field supply voltage may be lower than the rated armature/field voltage (set via parameter; in the case of units with a 400 V rated voltage, an input voltage of up to 85 V is permitted). The output voltage decreases accordingly. The specified DC output voltage can be maintained up to an undervoltage of 5 % of the line supply voltage (rated armature/field supply voltage).

²⁾ Fan noise for a unit installed in an IP20 electrical cabinet (door closed, 50 Hz operation or operation at 24 V DC for units with an internal supply).

³⁾ For fan motor type R2D220-AB02-19 in units 6RA8081, 6RA8085, and 6RA8087 with a rated voltage of 400 V or 575 V, UL systems require a Siemens motor circuit-breaker of type 3RV1011-0DA1 or 3RV1011-0EA1, set to 0.3 A.

⁴⁾ For fan motor type RH28M-2DK.3F.1R in units 6RA8090, 6RA8091, 6RA8093, and 6RA8095 with a rated voltage of 400 V or 575 V, UL systems require a Siemens motor circuit-breaker of type 3RV1011-0KA1 or 3RV1011-1AA1, set to 1.25 A.

⁵⁾ Derating factors for higher temperatures and installation altitudes, see page 3/8.

Technical specifications (continued)

SINAMICS DC MASTER converters for 830 V 3 AC, 950 to 1 900 A and 950 V 3 AC, 2 200 A, four-quadrant operation

	Type	Type			
		6RA8088-6LV62-0AA0	6RA8093-4LV62-0AA0	6RA8095-4LV62-0AA0	6RA8096-4MV62-0AA0
Rated armature supply voltage ¹⁾	V	830 V 3 AC (+10/-20 %)			950 V 3 AC (+15/-20 %)
Rated armature input current	A	789	1 245	1 577	1 826
Rated supply voltage, electronics power supply	V	380 (-25 %) ... 480 V (+10 %) 2 AC; $I_n = 1$ A or 190 (-25 %) ... 240 V (+10 %) 2 AC; $I_n = 2$ A			
Rated fan supply voltage	V	400 V 3 AC ± 10 % (50 Hz) 460 V 3 AC ± 10 % (60 Hz)			
Rated fan current	A	0.3 ³⁾	1 ⁴⁾		
Air flow	m ³ /h	1 000	2 400		
Sound pressure level ²⁾	dB (A)	64.5	75.6		
Rated field supply voltage ¹⁾	V	480 V 2 AC (+10/-20 %)			
Rated frequency	Hz	45 ... 65			
Rated DC voltage ¹⁾	V	875			1 000
Rated DC current	A	950	1 500	1 900	2 200
Overload capability	$x \times I_n$	1.8			
Rated power	kW	831	1 313	1 663	2 200
Power loss at rated DC current	kW	4.22	7.12	8.67	11.34
Rated DC field voltage ¹⁾	V	max. 390			
Rated DC field current	A	40			
Normal ambient temperature in operation ⁵⁾	°C	0 ... +40			
Storage and transport temperature	°C	-40 ... +70			
Installation altitude above sea level ⁵⁾		≤ 1 000 m for rated DC current			
Dimensions					
• Width	mm	268	453		
• Height	mm	785	883		
• Depth	mm	435	505		
Weight, approx.	kg	78	155		185

Note:

Detailed dimension drawings in the PDF and DXF formats are available on the DVD-ROM supplied with this catalog and in the Internet under www.siemens.com/sinamics-dcm (information material).

¹⁾ The armature/field supply voltage may be lower than the rated armature/field voltage (set via parameter; in the case of units with a 400 V rated voltage, an input voltage of up to 85 V is permitted). The output voltage decreases accordingly. The specified DC output voltage can be maintained up to an undervoltage of 5 % of the line supply voltage (rated armature/field supply voltage).

²⁾ Fan noise for a unit installed in an IP20 electrical cabinet (door closed, 50 Hz operation or operation at 24 V DC for units with an internal supply).

³⁾ For fan motor type R2D220-AB02-19 in units 6RA8081, 6RA8085, and 6RA8087 with a rated voltage of 400 V or 575 V, UL systems require a Siemens motor circuit-breaker of type 3RV1011-0DA1 or 3RV1011-0EA1, set to 0.3 A.

⁴⁾ For fan motor type RH28M-2DK.3F.1R in units 6RA8090, 6RA8091, 6RA8093, and 6RA8095 with a rated voltage of 400 V or 575 V, UL systems require a Siemens motor circuit-breaker of type 3RV1011-0KA1 or 3RV1011-1AA1, set to 1.25 A.

⁵⁾ Derating factors for higher temperatures and installation altitudes, see page 3/8.

SINAMICS DCM

DC Converter and Control Module

DC Converter

Selection and ordering data

DC Converters for two-quadrant operation

Rated data				DC Converter			Fuses					
Armature circuit		Rated DC current	Rated power	Field circuit		Order No.	Armature circuit		Field circuit			
Rated supply voltage ¹⁾	Rated DC voltage			Rated supply voltage ¹⁾	Rated DC current		Phase	DC current	2 each			
V	V	A	kW	V	A		Type	Type	Type			
400 V 3 AC	485	60	29	400 V 2 AC	10	6RA8025-6DS22-0AA0	3NE1817-0	-	5SD420			
		90	44		10	6RA8028-6DS22-0AA0	3NE1820-0	-	5SD420			
		125	61		10	6RA8031-6DS22-0AA0	3NE1021-0	-	5SD420			
		210	102		15	6RA8075-6DS22-0AA0	3NE3227	-	5SD440			
		280	136		15	6RA8078-6DS22-0AA0	3NE3231	-	5SD440			
		400	194		25	6RA8081-6DS22-0AA0	3NE3233	-	5SD440			
		600	291		25	6RA8085-6DS22-0AA0	3NE3336	-	5SD440			
		850	412	30	6RA8087-6DS22-0AA0	3NE3338-8	-	5SD480				
		1 200	582	480 V 2 AC	40	6RA8091-6DS22-0AA0	- ²⁾	-	3NE1802-0 ³⁾			
		1 600	776		40	6RA8093-4DS22-0AA0	- ²⁾	-	3NE1802-0 ³⁾			
		2 000	970		40	6RA8095-4DS22-0AA0	- ²⁾	-	3NE1802-0 ³⁾			
		3 000	1 455		40	6RA8098-4DS22-0AA0	- ²⁾	-	3NE1802-0 ³⁾			
		480 V 3 AC	575	60	35	480 V 2 AC	10	6RA8025-6FS22-0AA0	3NE1817-0	-	5SD420	
90	52			10	6RA8028-6FS22-0AA0		3NE1820-0	-	5SD420			
125	72			10	6RA8031-6FS22-0AA0		3NE1021-0	-	5SD420			
210	121			15	6RA8075-6FS22-0AA0		3NE3227	-	5SD440			
280	161			15	6RA8078-6FS22-0AA0		3NE3231	-	5SD440			
450	259			25	6RA8082-6FS22-0AA0		3NE3233	-	5SD440			
600	345			25	6RA8085-6FS22-0AA0		3NE3336	-	5SD440			
850	489			30	6RA8087-6FS22-0AA0		3NE3338-8	-	5SD480			
1 200	690			40	6RA8091-6FS22-0AA0		- ²⁾	-	3NE1802-0 ³⁾			
575 V 3 AC	690			60	41		480 V 2 AC	10	6RA8025-6GS22-0AA0	3NE1817-0	-	5SD420
				125	86			10	6RA8031-6GS22-0AA0	3NE1021-0	-	5SD420
				210	145			15	6RA8075-6GS22-0AA0	3NE3227	-	5SD440
				400	276			25	6RA8081-6GS22-0AA0	3NE3233	-	5SD440
		600	414	25	6RA8085-6GS22-0AA0	3NE3336		-	5SD440			
		800	552	30	6RA8087-6GS22-0AA0	3NE3338-8		-	5SD480			
		1 100	759	40	6RA8090-6GS22-0AA0	- ²⁾		-	3NE1802-0 ³⁾			
		1 600	1 104	40	6RA8093-4GS22-0AA0	- ²⁾		-	3NE1802-0 ³⁾			
		2 000	1 380	40	6RA8095-4GS22-0AA0	- ²⁾		-	3NE1802-0 ³⁾			
		2 200	1 518	40	6RA8096-4GS22-0AA0	- ²⁾		-	3NE1802-0 ³⁾			
		2 800	1 932	40	6RA8097-4GS22-0AA0	- ²⁾		-	3NE1802-0 ³⁾			
		690 V 3 AC	830	720	598	480 V 2 AC		30	6RA8086-6KS22-0AA0	3NE3337-8	-	5SD480
				1 000	830			40	6RA8090-6KS22-0AA0	- ²⁾	-	3NE1802-0 ³⁾
1 500	1 245			40	6RA8093-4KS22-0AA0		- ²⁾	-	3NE1802-0 ³⁾			
2 000	1 660			40	6RA8095-4KS22-0AA0		- ²⁾	-	3NE1802-0 ³⁾			
2 600	2 158			40	6RA8097-4KS22-0AA0		- ²⁾	-	3NE1802-0 ³⁾			
830 V 3 AC	1 000	950	950	480 V 2 AC	40	6RA8088-6LS22-0AA0	- ²⁾	-	3NE1802-0 ³⁾			
		1 500	1 500		40	6RA8093-4LS22-0AA0	- ²⁾	-	3NE1802-0 ³⁾			
		1 900	1 900		40	6RA8095-4LS22-0AA0	- ²⁾	-	3NE1802-0 ³⁾			
950 V 3 AC	1 140	2 200	2 508	480 V 2 AC	40	6RA8096-4MS22-0AA0	- ²⁾	-	3NE1802-0 ³⁾			

¹⁾ 50/60 Hz

²⁾ Arm fuses included in the unit, external semiconductor fuses not required.

³⁾ UL-recognized

Selection and ordering data (continued)

DC Converters for four-quadrant operation

Rated data				Field circuit		DC Converter		Fuses		Field circuit		
Armature circuit		Rated DC current	Rated power	Rated supply voltage ¹⁾	Rated DC current	Order No.	Armature circuit		Field circuit			
Rated supply voltage ¹⁾	Rated DC voltage						Phase	DC current	2 each			
V	V	A	kW	V	A		Type	Type	Type			
400 V 3 AC	420	15	6.3	400 V 2 AC	3	6RA8013-6DV62-0AA0	3NE1814-0	3NE1814-0	5SD420			
		30	12.6		5	6RA8018-6DV62-0AA0	3NE8003-1	3NE4102	5SD420			
		60	25		10	6RA8025-6DV62-0AA0	3NE1817-0	3NE4120	5SD420			
		90	38		10	6RA8028-6DV62-0AA0	3NE1820-0	3NE4122	5SD420			
		125	53		10	6RA8031-6DV62-0AA0	3NE1021-0	3NE4124	5SD420			
		210	88		15	6RA8075-6DV62-0AA0	3NE3227	3NE3227	5SD440			
		280	118		15	6RA8078-6DV62-0AA0	3NE3231	3NE3231	5SD440			
		400	168		25	6RA8081-6DV62-0AA0	3NE3233	3NE3233	5SD440			
		600	252		25	6RA8085-6DV62-0AA0	3NE3336	3NE3336	5SD440			
		850	357		30	6RA8087-6DV62-0AA0	3NE3338-8	3NE3334-0B ³⁾	5SD480			
		1 200	504		480 V 2 AC	40	6RA8091-6DV62-0AA0	- ²⁾	- ²⁾	3NE1802-0 ⁴⁾		
		1 600	672			40	6RA8093-4DV62-0AA0	- ²⁾	- ²⁾	3NE1802-0 ⁴⁾		
		2 000	840			40	6RA8095-4DV62-0AA0	- ²⁾	- ²⁾	3NE1802-0 ⁴⁾		
3 000	1 260	40	6RA8098-4DV62-0AA0	- ²⁾	- ²⁾	3NE1802-0 ⁴⁾						
480 V 3 AC	500	15	6	480 V 2 AC	3	6RA8013-6FV62-0AA0	3NE1814-0	3NE1814-0	5SD420			
		30	15		5	6RA8018-6FV62-0AA0	3NE1815-0	3NE4102	5SD420			
		60	30		10	6RA8025-6FV62-0AA0	3NE1817-0	3NE4120	5SD420			
		90	45		10	6RA8028-6FV62-0AA0	3NE1820-0	3NE4122	5SD420			
		125	63		10	6RA8031-6FV62-0AA0	3NE1021-0	3NE4124	5SD420			
		210	105		15	6RA8075-6FV62-0AA0	3NE3227	3NE3227	5SD440			
		280	140		15	6RA8078-6FV62-0AA0	3NE3231	3NE3231	5SD440			
		450	225		25	6RA8082-6FV62-0AA0	3NE3233	3NE3334-0B	5SD440			
		600	300		25	6RA8085-6FV62-0AA0	3NE3336	3NE3336	5SD440			
		850	425		30	6RA8087-6FV62-0AA0	3NE3338-8	3NE3334-0B ³⁾	5SD480			
		1 200	600		40	6RA8091-6FV62-0AA0	- ²⁾	- ²⁾	3NE1802-0 ⁴⁾			
		575 V 3 AC	600		60	36	480 V 2 AC	10	6RA8025-6GV62-0AA0	3NE1817-0	3NE4120	5SD420
					125	75		10	6RA8031-6GV62-0AA0	3NE1021-0	3NE4124	5SD420
210	126			15	6RA8075-6GV62-0AA0	3NE3227		3NE3227	5SD440			
400	240			25	6RA8081-6GV62-0AA0	3NE3233		3NE3233	5SD440			
600	360			25	6RA8085-6GV62-0AA0	3NE3336		3NE3336	5SD440			
850	510			30	6RA8087-6GV62-0AA0	3NE3338-8		3NE3334-0B ³⁾	5SD480			
1 100	660			40	6RA8090-6GV62-0AA0	- ²⁾		- ²⁾	3NE1802-0 ⁴⁾			
1 600	960			40	6RA8093-4GV62-0AA0	- ²⁾		- ²⁾	3NE1802-0 ⁴⁾			
2 000	1 200			40	6RA8095-4GV62-0AA0	- ²⁾		- ²⁾	3NE1802-0 ⁴⁾			
2 200	1 320			40	6RA8096-4GV62-0AA0	- ²⁾		- ²⁾	3NE1802-0 ⁴⁾			
2 800	1 680			40	6RA8097-4GV62-0AA0	- ²⁾		- ²⁾	3NE1802-0 ⁴⁾			
690 V 3 AC	725	760	551	480 V 2 AC	30	6RA8086-6KV62-0AA0	3NE3337-8	3NE3334-0B ³⁾	5SD420			
		1 000	725		40	6RA8090-6KV62-0AA0	- ²⁾	- ²⁾	3NE1802-0 ⁴⁾			
		1 500	1 088		40	6RA8093-4KV62-0AA0	- ²⁾	- ²⁾	3NE1802-0 ⁴⁾			
		2 000	1 450		40	6RA8095-4KV62-0AA0	- ²⁾	- ²⁾	3NE1802-0 ⁴⁾			
		2 600	1 885		40	6RA8097-4KV62-0AA0	- ²⁾	- ²⁾	3NE1802-0 ⁴⁾			
830 V 3 AC	875	950	831	480 V 2 AC	40	6RA8088-6LV62-0AA0	- ²⁾	- ²⁾	3NE1802-0 ⁴⁾			
		1 500	1 313		40	6RA8093-4LV62-0AA0	- ²⁾	- ²⁾	3NE1802-0 ⁴⁾			
		1 900	1 663		40	6RA8095-4LV62-0AA0	- ²⁾	- ²⁾	3NE1802-0 ⁴⁾			
950 V 3 AC	1 000	2 200	2 200	480 V 2 AC	40	6RA8096-4MV62-0AA0	- ²⁾	- ²⁾	3NE1802-0 ⁴⁾			

¹⁾ 50/60 Hz

²⁾ Arm fuses included in the unit, external semiconductor fuses not required.

³⁾ Two fuses connected in parallel.

⁴⁾ UL-recognized

SINAMICS DCM

DC Converter and Control Module

DC Converter

Options

Note:

When ordering a unit with options, add the suffix “-Z” after the Order No. and then state the order code(s) for the desired option(s) after the suffix.

Example:

6RA8075-6GV62-0AA0-Z
G00+G20+L85+...

See also ordering examples.

Available options

The following table provides an overview of the available options. Detailed descriptions of the options are provided in the section “Description of options”.

Designation	Order code	Notes	Order No. for separate order	
			not coated	coated
CUD				
Standard CUD left	(Standard)	–	6RY1803-0AA00	6RY1803-0AA20
Advanced CUD left	G00	–	6RY1803-0AA05	6RY1803-0AA25
Standard CUD right	G10	This option requires an Advanced CUD left – order code G00	6RY1803-0AA00 + 6RY1803-0GA00	6RY1803-0AA20 + 6RY1803-0GA20
Advanced CUD right	G11	This option requires an Advanced CUD left – order code G00	6RY1803-0AA05 + 6RY1803-0GA00	6RY1803-0AA25 + 6RY1803-0GA20
Communication Board CBE20 left	G20	This option requires an Advanced CUD left – order code G00	–	6SL3055-0AA00-2EB0
Communication Board CBE20 right	G21	This option requires an Advanced CUD right – order code G11	–	6SL3055-0AA00-2EB0
Memory card left	S01	–	6RX1800-0AS01	–
Memory card right	S02	This option requires a Standard CUD right – order code G10 – or an Advanced CUD right – order code G11	6RX1800-0AS01	–
Field				
Field power section 1Q	(Standard)	–	– ¹⁾	– ¹⁾
Field power section 2Q	L11	Only applicable for units from 60 to 3 000 A	– ¹⁾	– ¹⁾
Without field power section	L10	Only applicable for units from 60 to 3 000 A	–	–
85 A field power section	L85	Only applicable for units from 1 500 to 3 000 A	– ¹⁾	– ¹⁾
Fans				
Standard fan	(Standard)	Self-ventilated units do not have a fan	– ¹⁾	–
Fan for single-phase connection	L21	Only applicable for units from 400 to 1 200 A	– ¹⁾	–
Additional options				
Electronics power supply for connection to 24 V DC	L05	Standard for Control Module, input voltage range 18 to 30 V, current consumption 5 A at 24 V	– ¹⁾	– ¹⁾
Armature supply with extra-low voltage 10 to 50 V	L04	Only applicable for units up to ≤ 575 V rated supply voltage	– ¹⁾	– ¹⁾
Coated PCBs	M08	–	–	–
Nickel-plated copper busbars	M10	Only applicable for units from 60 to 3 000 A	–	–
External sensor for ambient or inlet temperature	L15	Only applicable for units from 1 500 to 3 000 A	– ¹⁾	–

¹⁾ Available as spare part.

Options (continued)

Option selection matrix

	G00	G10	G11	G20	G21	L04	L05	L10	L11	L15	L21	L85	M08	M10	S01	S02
G00		✓	✓	✓	✓	✓	✓	✓	✓	✓	✓	✓	✓	✓	✓	✓
G10	✓		–	✓	–	✓	✓	✓	✓	✓	✓	✓	✓	✓	✓	✓
G11	✓	–		✓	✓	✓	✓	✓	✓	✓	✓	✓	✓	✓	✓	✓
G20	✓	✓	✓		✓	✓	✓	✓	✓	✓	✓	✓	✓	✓	✓	✓
G21	✓	–	✓	✓		✓	✓	✓	✓	✓	✓	✓	✓	✓	✓	✓
L04	✓	✓	✓	✓	✓		✓	✓	✓	✓	✓	✓	✓	✓	✓	✓
L05	✓	✓	✓	✓	✓	✓		✓	✓	✓	✓	✓	✓	✓	✓	✓
L10	✓	✓	✓	✓	✓	✓	✓		–	✓	✓	–	✓	✓	✓	✓
L11	✓	✓	✓	✓	✓	✓	✓	–		✓	✓	✓	✓	✓	✓	✓
L15	✓	✓	✓	✓	✓	✓	✓	✓	✓		✓	✓	✓	✓	✓	✓
L21	✓	✓	✓	✓	✓	✓	✓	✓	✓	✓		✓	✓	✓	✓	✓
L85	✓	✓	✓	✓	✓	✓	✓	–	✓	✓	✓		✓	✓	✓	✓
M08	✓	✓	✓	✓	✓	✓	✓	✓	✓	✓	✓	✓		✓	✓	✓
M10	✓	✓	✓	✓	✓	✓	✓	✓	✓	✓	✓	✓	✓		✓	✓
S01	✓	✓	✓	✓	✓	✓	✓	✓	✓	✓	✓	✓	✓	✓		✓
S02	✓	✓	✓	✓	✓	✓	✓	✓	✓	✓	✓	✓	✓	✓	✓	

✓ Option can be combined without any restrictions

– Option cannot be combined

SINAMICS DCM

DC Converter and Control Module

DC Converter

Options (continued)

Ordering examples

Example 1

Application:

A DC drive system is required for a cableway. A SINAMICS DC MASTER is to handle the closed-loop control of the selected 560 kW DC motor with a rated armature voltage of 420 V and a rated armature current of 1 306 A. Due to the overdimensioning of 25 % specified by the acceptance authorities, and due to the maximum ambient temperature of 45 °C that can occur, the rated current of the converter had to be further reduced by 5 %. This is the reason that a unit with a rated supply current of 2 000 A was selected. The converter capable of energy recovery is to be connected to a 400 V line supply. A PROFINET connection is required for the higher-level control.

Solution:

A four-quadrant converter with 2 000 A and 400 V AC should be selected for this application. The incremental encoder to sense the speed – mounted on the motor – is directly evaluated in the CUD of the SINAMICS DC MASTER, without requiring any additional option.

The following options must be selected in order to permit the PROFINET connection:

G00 (Advanced CUD left)

G20 (PROFINET Communication Board CBE20 left)

The ordering data are as follows:

6RA8095-4DV62-0AA0-Z

G00+G20

Example 2

Application:

An unwinder for paper in a reeler-slitter is to be modernized – but the existing motor is to be kept. The power section is to be supplied from the existing 690 V supply. The technological control is to be implemented in the higher-level PCS7 system. The client specified PROFIBUS as the control and setpoint interface. The following measured values and status displays are to be visualized in the cabinet doors of the drive cabinet to facilitate fast and simple diagnostics for the service and maintenance personnel: Armature current, armature voltage, speed, field current, status messages – operation and fault.

The customer explained that he repeatedly had problems with the existing converter relating to overvoltage in the motor armature circuit – and as a consequence, this resulted in tension fluctuations in the paper web when the motor went into the field-weakening range. As a result of instability in the control voltage supply, in the past, there were repeatedly failures that had a negative impact on the availability.

Solution:

As a result of the data of the existing motor and the customer specifications relating to acceleration and braking ramps, tambour roll weight and maximum diameter, a four-quadrant converter was selected with a rated supply voltage of 690 V and a rated current of 1 500 A. The dynamic overload capability of the units is utilized to brake the drive when the paper web breaks.

The technological control with current setpoint interface is realized in the higher-level control. This is the reason that for this particular application, the Standard CUD is sufficient, which already has an integrated Profibus interface.

The problem with armature overvoltages when entering the field weakening range has now been resolved by selecting the two-quadrant field power section option. By actively reducing the current using a counter-voltage, the field current actual value can now follow the field current setpoint – even for steep acceleration ramps – and therefore overvoltages are avoided in the armature circuit. The tension fluctuations in the paper web are consequently eliminated.

Selecting the option “Electronics power supply for connection to 24 V DC” means that the drive system can be intergrated into a favorably-priced and low-maintenance DC UPS system comprising SITOP components.

The requirements regarding actual value and status displays were addressed by installing the AOP30 Advanced Operator Panel in the doors of the drive cabinet.

Coated PCBs and nickel-plated copper busbars were selected as a result of the aggressive atmosphere with a high percentage of H₂S.

The availability of equipment is extremely important in the paper industry. This is the reason that the option “memory card left” was selected to allow service and maintenance personnel short repair times in the case of faults. Software and additional languages of the AOP text are saved on this card. Further, parameter values can be additionally saved there and there is a reserved memory range for offline long-time trace records.

The following options must be selected for this particular application:

L05 (electronics power supply for connection to 24 V DC)

L11 (2Q field power section)

M08 (coated PCBs)

M10 (nickel-plated copper busbars)

S01 (memory card left)

Further, the following accessories are required:
Advanced Operator Panel AOP30 (6SL3055-0AA00-4CA)
RS485 cable, 3 m long

The ordering data are as follows:

6RA8093-4KV62-0AA0-Z

L05+L11+M08+M10+S01

and

6SL3055-0AA00-4CA

as well as

6GRY1807-0AP00

Options (continued)

Description of options

G00

Advanced CUD left

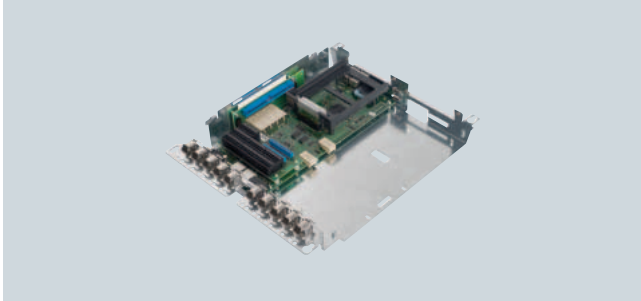

In addition to the connections and functions of the Standard CUD, the Advanced CUD has two DRIVE-CLiQ connections and one option slot. The use of an Advanced CUD also provides the opportunity of inserting an additional CUD (Standard or Advanced) to increase the computational performance and the number of terminals. This can be used, e.g. to implement additional technological functions.

By using an Advanced CUD, which is located in the lefthand slot instead of the Standard CUD, the SINAMICS SMC30, TM15, TM31 and CBE20 components can be connected to the SINAMICS DC MASTER. More detailed information on the SINAMICS components is available in the catalog section "Accessories and supplementary components".

G10

Standard CUD right

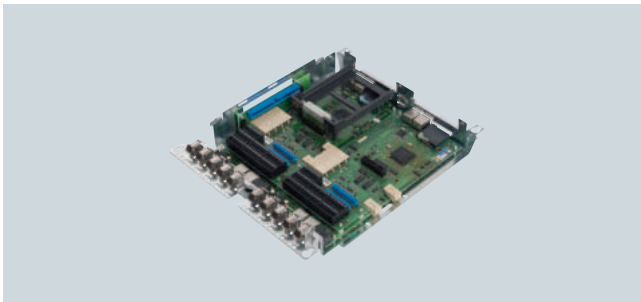

Selecting option **G10** provides the possibility of further increasing the performance of technology functions for the SINAMICS DC MASTER. As a result of the additional Standard CUD that is inserted in the righthand slot of the electronics tray, users have additional computational performance at their fingertips in order to fulfill even the highest demands when it comes to closed-loop control performance. Option **G00** is required when selecting option **G10**. An extension to include two Control Units is only possible when the Advanced CUD is inserted in the lefthand slot.

G11

Advanced CUD right

With option **G11**, users can address the highest demands regarding the closed-loop control performance and use the wide range of interfaces. With this option, in addition to the Advanced CUD located in the lefthand slot, an additional Advanced CUD can be mounted in the righthand slot. This therefore doubles the number of interfaces of the SINAMICS DC MASTER. Option **G00** is required when selecting option **G11**. An extension to include two Control Units is only possible when the Advanced CUD is inserted in the lefthand slot.

G20

Communication Board CBE20 left

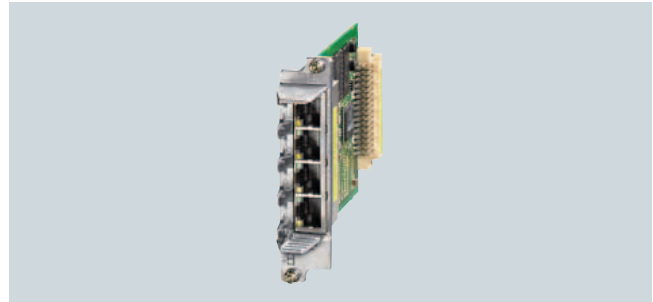

The CBE20 Communication Board can be used to connect to a PROFINET IO network via the Advanced CUD.

The SINAMICS DC MASTER then assumes the function of a PROFINET IO device in the sense of PROFINET and offers the following functions:

- PROFINET IO device
- 100 Mbps/s full duplex
- Supports real-time classes of PROFINET IO:
- RT (Real-Time)
- Connection to control systems as PROFINET IO devices in accordance with PROFIdrive, Specification V4.1.
- In addition to PROFIBUS (standard), PROFINET can also be used for engineering with the STARTER commissioning tool.
- Integrated 4-port switch with four RJ45 sockets based on the PROFINET ASIC ERTEC400. The optimum topology (line, star, tree) can therefore be configured without additional external switches.
- The SINAMICS Link function can be used in conjunction with option S01 or S02.

The CBE20 is inserted in the option slot of the Advanced CUD, which is inserted in the lefthand slot. An Advanced CUD must be located in the lefthand slot in order to be able to use option **G20**. This can be selected with option **G00**.

Technical data	
Permissible ambient temperature	
• Storage and transport	-40 ... +70 °C
• Operation	0 ... 55 °C
Approvals	cULus (File No.: E164110)

Accessories for CBE20	Type
Industrial Ethernet FC	
• RJ45 Plug 145 (1 plug)	6GK1901-1BB30-0AA0
• RJ45 Plug 145 (10 plugs)	6GK1901-1BB30-0AB0
• Stripping tool	6GK1901-1GA00
• Standard cable GP 2x2	6XV1840-2AH10
• Flexible cable GP 2x2	6XV1870-2B
• Trailing cable GP 2x2	6XV1870-2D
• Trailing cable 2x2	6XV1840-3AH10
• Marine cable 2x2	6XV1840-4AH10

The cables are sold by the meter.

For further information about connectors and cables, refer to Catalog IK PI.

SINAMICS DCM

DC Converter and Control Module

DC Converter

Options (continued)

G21

Communication Board CBE20 right

With option G21, an Advanced CUD inserted in the righthand slot (refer to option G11) can be extended by the CBE20. More detailed information on the functionality, selection and ordering data of the CBE20 is available under option G20.

L04

Armature supply with extra-low voltage 10 to 50 V

With option L04, the SINAMICS DC MASTER is re-equipped for operation with 10 to 50 V AC. This is frequently required especially for electrochemical applications, when controlling solenoids, when using the converter to supply the fields of special motors or Ward-Leonard converters (MG sets).

This option can only be selected for units with rated supply voltages of up to 575 V.

L05

Electronics power supply for connection to 24 V DC

With option L05, users have the possibility of equipping SINAMICS DC MASTER with an electronics power supply for connection to 24 V DC instead of the standard electronics power supply. This option allows users to connect the units to a favorably-priced 24 V UPS system.

This option cannot be selected for Control Modules as the Control Module is supplied as standard with an electronics power supply for connection to 24 V DC.

Input voltage range: 18 to 30 V,
current consumption: 5 A at 24 V

L10

Without field power section

In some applications it may be necessary to individually adapt the field power section. For this particular case, users can order option L10 where SINAMICS DC MASTER is not equipped with the standard integrated field power section. This then allows them to implement their own individual solutions for the field power section.

This option cannot be ordered for units with rated DC currents from 15 to 30 A.

L11

2Q field power section

For applications that demand high speed field current changes, by specifying option L11, the SINAMICS DC MASTER can be equipped with a two-quadrant field with active current reduction. Further, this field power section has an integrated field overvoltage protection.

This option cannot be ordered for units with rated DC currents from 15 to 30 A.

L15

External sensor for ambient or inlet temperature

Option L15 is a sensor located outside the unit to measure the ambient or inlet temperature. For example, this can be used to simply monitor the cabinet temperature and/or identify when the air intake filter is blocked.

This option is only available for units with rated DC currents from 1 500 to 3 000 A.

L21

Fan for single-phase connection

A fan can be optionally supplied with a single-phase connection for units with rated DC currents between 400 and 1 200 A. This allows fans to be more quickly replaced than three-phase fans – especially as the direction of rotation does not have to be checked.

Units smaller than 400 A are self-ventilated or have an integrated 24 V DC fan. Units with ratings of greater than 1 200 A require a three-phase connection for the fan due to the higher power consumption. Rated supply voltage: 230 V 1 AC \pm 10 % (50 and 60 Hz).

L85

85 A field power section

With option L85, users can have the SINAMICS DC MASTER equipped with a rated DC field current of 85 A.

This option can only be ordered for units with rated DC currents from 1 500 to 3 000 A.

M08

Coated PCBs

In order to improve the reliability for increased degrees of pollution and climatic stressing, it is possible to order PCBs of the SINAMICS DC MASTER that are coated on both sides by specifying option M08.

M10

Nickel-plated copper busbars

When ordered with Option M10, the SINAMICS DC MASTER is equipped with nickel-plated copper busbars. The degree of availability can be increased for aggressive atmospheres.

This option is not available for units with rated DC currents from 15 to 30 A.

S01

Memory card left

With option S01, users receive a memory card for one Standard CUD or one Advanced CUD, which is inserted in the lefthand slot.

This memory card offers the following options:

- Additional languages can be downloaded to the Advanced Operator Panel AOP30. When using two CUDs, option S01 and option S02 must be ordered.
- Perform an offline long-time trace.
- Download the DCC block library into the drive.
- Update the software.

The SINAMICS Link function requires that the memory card is always inserted.

S02

Memory card right

With option S02, users receive a memory card for one Standard CUD or one Advanced CUD, which is inserted in the righthand slot.

This memory card offers the following options:

- Additional languages can be downloaded to the Advanced Operator Panel AOP30. When using two CUDs, option S01 and option S02 must be ordered.
- Perform an offline long-time trace.
- Download the DCC block library into the drive.
- Update the software.

The SINAMICS Link function requires that the memory card is always inserted.

In order to be able to use option S02, a Standard CUD right (option G10) or an Advanced CUD right (option G11) is required.

Schematics

Control Units

3

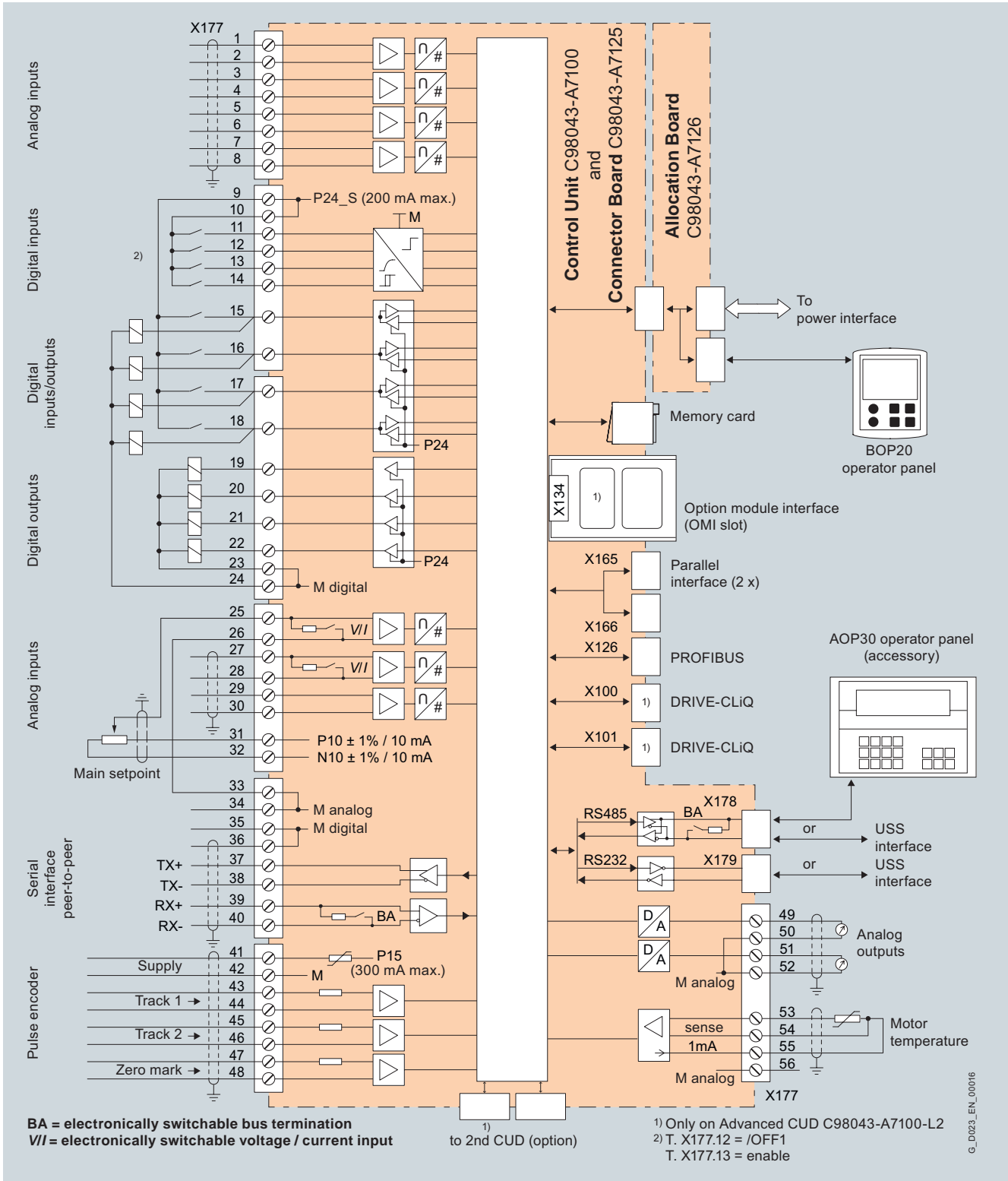

Connection diagram, Standard CUD/Advanced CUD with typical connections

SINAMICS DCM

DC Converter and Control Module

DC Converter

Schematics (continued)

DC Converters

3

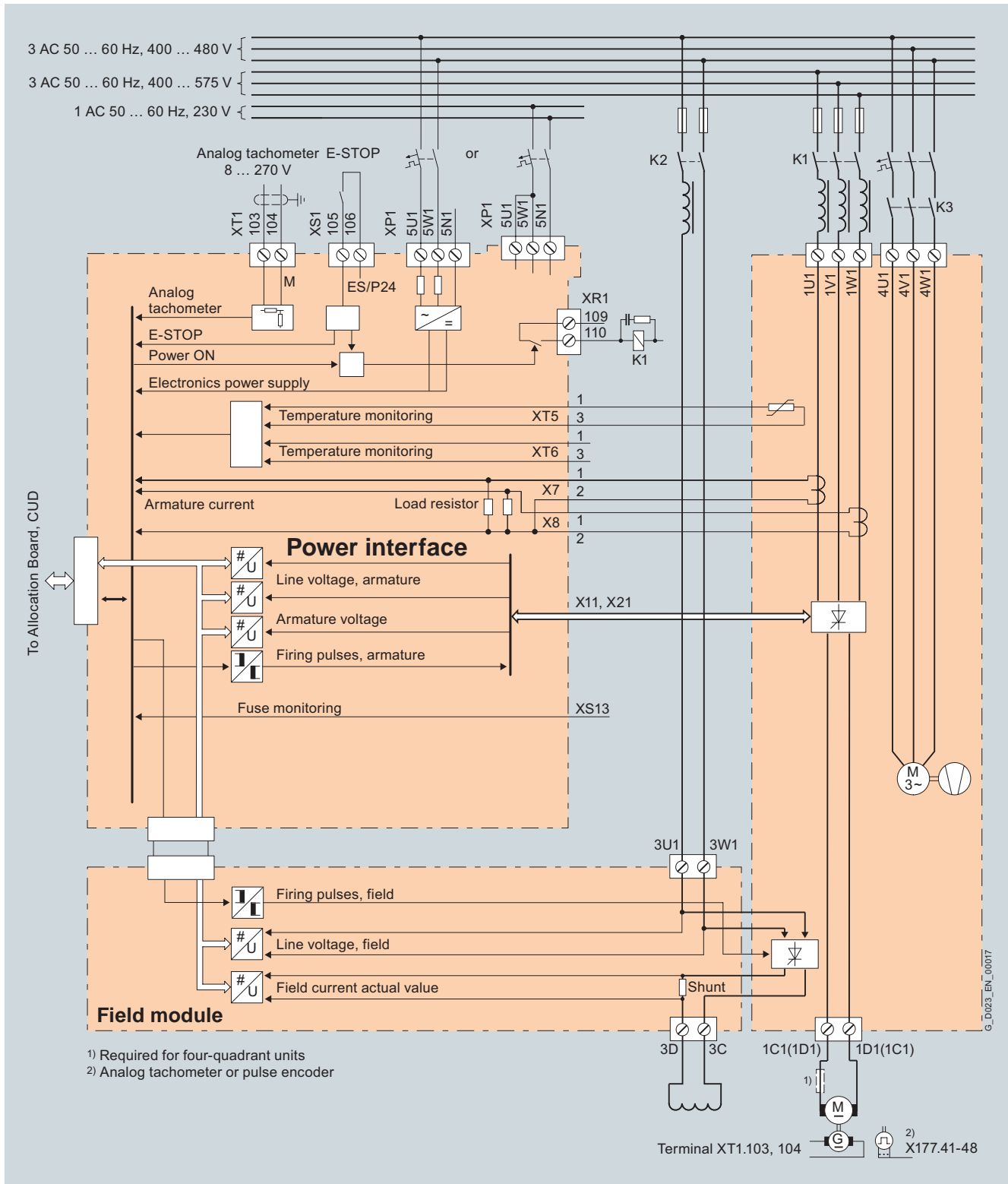

Connection diagram, DC Converters, 400 to 3 000 A, electronics power supply 400 V or 230 V, with fan

Schematics (continued)

Assignment of terminals and connectors

Overview

Overview of terminals and connectors

1U1, 1V1, 1W1, 1C1, 1D1	Power section
3U1, 3W1, 3C, 3D	Field circuit
4U1, 4V1, 4W1, 4N1	Fan
5U1, 5W1, 5N1	Electronics power supply
X100, X101	DRIVE-CLiQ
X126	PROFIBUS
X165, X166	Parallel connection interface
X177	Analog inputs, digital inputs, digital outputs, setpoints, reference voltage (P10/N10), serial interface (peer-to-peer), pulse encoder, analog outputs, temperature sensor
X178	RS485 interface for connection of the AOP30, alternatively USS interface; generally only one of the interfaces X178 or X179 can be used
X179	RS232 interface can be used as USS interface; generally only one of the interfaces X178 or X179 can be used
XR1, XS1, XT1	Relay output for line contactor, safety shutdown (E-STOP), analog tachometer

Power section

Terminal type, power connections for 15 A and 30 A units

Type	KDS 10 PC board terminal
Conductor size	<ul style="list-style-type: none"> Rigid: 0.5 ... 16 mm² Flexible with end sleeve with/without plastic sleeve: 0.5 ... 10 mm² Conductor sizes: AWG 20 ... 6
Stripped length	12 mm
Tightening torque	1.2 ... 1.5 Nm

Terminal type, power connections for units of 60 A and higher

Units	Data
60 ... 210 A	1U1, 1V1, 1W1: 3 × 20 mm aluminum busbar, through hole for M8 1C1, 1D1: 5 × 20 mm aluminum busbar, through hole for M8 Max. conductor cross-section for cables with cable lug in acc. with DIN 46234: 1U1, 1V1, 1W1, 1C1, 1D1: 2 × 95 mm ² Tightening torque for 1U1, 1V1, 1W1, 1C1, 1D1: 13 Nm Tightening torque for protective conductor: 25 Nm
280 A	1U1, 1V1, 1W1: 3 × 20 mm copper busbar, through hole for M8 1C1, 1D1: 5 × 20 mm copper busbar, through hole for M8 Max. conductor cross-section for cables with cable lug in acc. with DIN 46234: 1U1, 1V1, 1W1, 1C1, 1D1: 2 × 95 mm ² Tightening torque for 1U1, 1V1, 1W1, 1C1, 1D1: 13 Nm Tightening torque for protective conductor: 25 Nm
400 ... 450 A	1U1, 1V1, 1W1: 5 × 30 mm aluminum busbar, through hole for M10 1C1, 1D1: 5 × 35 mm aluminum busbar, through hole for M10 Max. conductor cross-section for cables with cable lug in acc. with DIN 46234: 1U1, 1V1, 1W1: 2 × 150 mm ² 1C1, 1D1: 2 × 185 mm ² Tightening torque for 1U1, 1V1, 1W1, 1C1, 1D1: 25 Nm Tightening torque for protective conductor: 50 Nm
600 A	1U1, 1V1, 1W1: 5 × 30 mm copper busbar, through hole for M10 1C1, 1D1: 5 × 35 mm copper busbar, through hole for M10 Max. conductor cross-section for cables with cable lug in acc. with DIN 46234: 1U1, 1V1, 1W1: 2 × 150 mm ² 1C1, 1D1: 2 × 185 mm ² Tightening torque for 1U1, 1V1, 1W1, 1C1, 1D1: 25 Nm Tightening torque for protective conductor: 50 Nm
720 ... 850 A	1U1, 1V1, 1W1, 1C1, 1D1: 5 × 60 mm copper busbar, through hole for M12 Max. conductor cross-section for cables with cable lug in acc. with DIN 46234: 1U1, 1V1, 1W1, 1C1, 1D1: 4 × 150 mm ² Tightening torque for 1U1, 1V1, 1W1, 1C1, 1D1: 44 Nm Tightening torque for protective conductor: 50 Nm

Protective conductor:

Minimum cross-section 10 mm², for connection options, see dimension drawings.

SINAMICS DCM

DC Converter and Control Module

DC Converter

Schematics (continued)

Terminal type, power connections for units of 60 A and higher (continued)

Units	Data
900 ... 1 200 A	1U1, 1V1, 1W1, 1C1, 1D1: 10 × 80 mm copper busbar, through hole for M12 Max. conductor cross-section for cables with cable lug in acc. with DIN 46234: 1U1, 1V1, 1W1, 1C1, 1D1: 4 × 150 mm ² Tightening torque for 1U1, 1V1, 1W1, 1C1, 1D1: 44 Nm Tightening torque for protective conductor: 60 Nm
1 500 ... 2 000 A and 2 200 A/575 V	1U1, 1V1, 1W1: 10 × 80 mm aluminum busbar, through hole for M12 1C1, 1D1: 10 × 50 mm aluminum busbar, through hole for M12 Max. conductor cross-section for cables with cable lug in acc. with DIN 46234: 1U1, 1V1, 1W1: 4 × 240 mm ² 1C1, 1D1: 8 × 240 mm ² Tightening torque for 1U1, 1V1, 1W1, 1C1, 1D1: 44 Nm Tightening torque for protective conductor: 60 Nm
2 200 A (> 575 V) ... 3 000 A	1U1, 1V1, 1W1: 2x 10 × 100 mm copper busbar, through hole for M12 1C1, 1D1: 2x 10 × 80 mm copper busbar, through hole for M12 Tightening torque for 1U1, 1V1, 1W1, 1C1, 1D1: 44 Nm Tightening torque for protective conductor: 60 Nm

Protective conductor:
Minimum cross-section 10 mm², for connection options, see dimension drawings.

The units are designed for a permanent line supply connection in accordance with DIN VDE 0160-106, Section 6.5.2.1.

The conductor cross-sections must be determined in accordance with the regulations that apply in each case – e.g. DIN VDE 0276-1000.

Assignment of power connections

Terminal	Function	Technical data
1U1 1V1 1W1	Line input armature power section	See under "Technical specifications" (Rated armature supply voltage)
	Protective conductor PE	
1C1 (1D1) 1D1 (1C1)	Motor connection armature circuit	See under "Technical specifications" (Rated DC voltage)

Field circuit

Terminal type, field circuit connections

Units with power section C98043-A7111 (15 and 30 A units) and units with field module C98043-A7115 (the terminals are located on the module):

Type	ZFKDS 4-10 PC board terminal
Conductor size	<ul style="list-style-type: none"> Rigid: 0.2 ... 6 mm² Flexible: 0.2 ... 4 mm² Conductor sizes: AWG 24 ... 10 Flexible with end sleeve with/without plastic sleeve: 0.25 ... 4 mm²
Stripped length	10 mm

Units with field module C98043-A7116 with rated armature DC current 900 ... 1 200 A:

Type	20E/4DS terminal strip
Conductor size	<ul style="list-style-type: none"> Rigid: 6 ... 16 mm² Flexible: 6 ... 10 mm²
Stripped length	8 mm

Units with field module C98043-A7116 with rated armature DC current 1 500 ... 3 000 A:

Type	UK16N terminal block
Conductor size	<ul style="list-style-type: none"> Rigid: 2.5 ... 25 mm², AWG 14 ... 4 Flexible: 4 ... 16 mm², AWG 12 ... 6
Stripped length	11 mm
Tightening torque	1.5 ... 1.8 Nm

Schematics (continued)*Terminal type, field circuit connections (continued)***Units with option L85 (with rated field DC current 85 A):**

Type	UK35 terminal block
Conductor size	<ul style="list-style-type: none"> • Rigid: 0.75 ... 50 mm² • Flexible: 0.75 ... 35 mm² • Conductor sizes: AWG 18 ... 0/1 • Flexible with end sleeve with/without plastic sleeve: 0.75 ... 35 mm²
Stripped length	16 mm
Tightening torque	3.2 ... 3.7 Nm



Assignment of connections for the field circuit

Terminal	Function	Technical data
XF1: 3U1, 3W1	Line input armature power section field circuit	See under "Technical specifications" (Rated field supply voltage)
XF2-1: 3D XF2-2: 3C	Motor connection field circuit	See under "Technical specifications" (Rated field DC voltage)

Electronics power supply*Terminal type, electronics power supply*

Type	MSTB 2.5 / CIF plug-in terminal
Conductor size	<ul style="list-style-type: none"> • Rigid: 0.2 ... 2.5 mm² • Flexible: 0.2 ... 2.5 mm² • Conductor sizes: AWG 24 ... 12 • Flexible with end sleeve with/without plastic sleeve: 0.25 ... 2.5 mm² <p>Multi-conductor connection (2 conductors of the same type and with same cross-section):</p> <ul style="list-style-type: none"> • Rigid: 0.2 ... 1 mm² • Flexible: 0.2 ... 1.5 mm² • Flexible with end sleeve without plastic sleeve: 0.25 ... 1 mm² • Flexible with end sleeve with plastic sleeve: 0.5 ... 1.5 mm²
Stripped length	7 mm
Tightening torque	0.5 ... 0.6 Nm

Assignment of terminals for the electronics power supply

Terminal	Connection	Function	Technical data
XP1			
5U1 5W1 5N1		400 V supply	380 V (-25 %) ... 480 V (+10 %) 2 AC; $I_n = 1$ A (-35 % for 1 min) Internal fuse with F200, F201 on module C98043-A7105 or -A7106 External protection max. 6 A, characteristic C recommended
or			
5U1 5W1 5N1		230 V supply	190 V (-25 %) ... 240 V (+10 %) 1 AC; $I_n = 2$ A (-35 % for 1 min) Internal fuse with F200, F201 on module C98043-A7105 or -A7106 External protection max. 6 A, characteristic C recommended

Module C98043-A7105 Power Interface 400 ... 600 V or C98043-A7106 Power Interface 690 ... 950 V

Note:

In the case of line supply voltages that fall outside the tolerance range, the electronics supply voltage, field circuit line supply connection, and the unit fan connection must be adapted to the permissible value using transformers. It is absolutely essential that you use an isolation transformer for rated line supply voltages above 480 V.

The rated supply voltage for the armature circuit (index i00) and for the field circuit (index i01) must be set at p50078.

SINAMICS DCM

DC Converter and Control Module

DC Converter

Schematics (continued)

Fans

Terminal type, fan connections for units ≥ 400 A with forced ventilation

Type	DFK-PC4 plug-in terminal
Conductor size	<ul style="list-style-type: none"> • Rigid: 0.2 ... 4 mm² • Flexible: 0.2 ... 4 mm² • Conductor sizes: AWG 24 ... 10

The connecting leads must be insulated up to the point where they meet the terminal enclosure.

Terminal assignment for fan connection

Terminal	Function	Technical data
4U1 4V1 4W1	400 ... 460 V supply	400 ... 460 V 3 AC for additional data, refer under "Technical specifications"
	Protective conductor PE	
or		
4U1 4N1	230 V supply	230 V 1 AC for additional data, refer under "Technical specifications"

Open-loop and closed-loop control section

Terminal type, open-loop and closed-loop control section

X177:	
Type	SPT 1.5 spring-loaded terminal
Conductor size	<ul style="list-style-type: none"> • Rigid: 0.2 ... 1.5 mm² • Flexible: 0.2 ... 1.5 mm² • Conductor sizes: AWG 24 ... 16 • Flexible with end sleeve without plastic sleeve: 0.25 ... 1.5 mm² (stripped length 8 mm) • Flexible with end sleeve with plastic sleeve: 0.25 ... 0.75 mm² (stripped length 8 mm)
Stripped length	10 mm
X178, X179:	
Type	FMC 1.5 plug-in terminal
Conductor size	<ul style="list-style-type: none"> • Rigid: 0.2 ... 1.5 mm² • Flexible: 0.2 ... 1.5 mm² • Conductor sizes: AWG 24 ... 16 • Flexible with end sleeve without plastic sleeve: 0.25 ... 1.5 mm² • Flexible with end sleeve with plastic sleeve: 0.25 ... 0.75 mm²
Stripped length	10 mm
XR1, XS1, XT1:	
Type	MSTB 2.5 / CIF plug-in terminal
Conductor size	<ul style="list-style-type: none"> • Rigid: 0.2 ... 2.5 mm² • Flexible: 0.2 ... 2.5 mm² • Conductor sizes: AWG 24 ... 12 Flexible with end sleeve with/without plastic sleeve: 0.25 ... 2.5 mm ²
Stripped length	7 mm
Tightening torque	0.5 ... 0.6 Nm
X126:	
Type	Submin D, 9-pin
X100, X101:	
Type	Western socket 8 / 4 (RJ45)

Schematics (continued)Terminals on Connector Board C98043-A7125*Assignment, terminal X177*

Terminal X177	Function	Technical data
Analog inputs (user-assignable inputs)		
1 2	AI3 + AI3 -	Analog input 3
3 4	AI4 + AI4 -	Analog input 4
5 6	AI5 + AI5 -	Analog input 5
7 8	AI6 + AI6 -	Analog input 6
Digital inputs (user-assignable inputs)		
9 10	24 V DC	24 V supply (output)
11	DI0	Digital input 0
12	DI1	Digital input 1
13	DI2	Digital input 2
14	DI3	Digital input 3
Digital inputs/outputs (user-assignable inputs/outputs)		
15	DI/ DO4	Digital input/ output 4
16	DI/ DO5	Digital input/ output 5
17	DI/ DO6	Digital input/ output 6
18	DI/ DO7	Digital input/ output 7
19	DO0	Digital output 0
20	DO1	Digital output 1
21	DO2	Digital output 2
22	DO3	Digital output 3
23, 24	M	Ground, digital
Analog inputs, setpoint inputs (user-assignable inputs)		
25 26	AI0 + AI0 -	Analog input 0 Main setpoint
27 28	AI1 + AI1 -	Analog input 1
29 30	AI2 + AI2 -	Analog input 2
Reference voltage		
31 32	P10 N10	Reference voltage ± 10 V (output)
33, 34	M	Ground, analog
Serial interface, peer-to-peer RS485		
35, 36	M	Ground, digital
37	TX+	Send cable +
38	TX-	Send cable -
39	RX+	Receive cable +
40	RX-	Receive cable -

SINAMICS DCM

DC Converter and Control Module

DC Converter

Schematics (continued)

Assignment, terminal X177 (continued)

Terminal X177	Function	Technical data
Pulse encoder input		
41	Pulse encoder supply	+13.7 ... +15.2 V, 300 mA short-circuit proof (electronically protected)
42	Pulse encoder ground	For overload: Alarm A60018
43	Track 1 positive connection	Load: ≤ 5.25 mA at 15 V (without switching losses)
44	Track 1 negative connection	Pulse duty factor: 1:1
45	Track 2 positive connection	See below for data relating to cables, cable length, shield connection, input pulse levels, hysteresis, track displacement, and pulse frequency.
46	Track 2 negative connection	
47	Zero mark positive connection	
48	Zero mark negative connection	
Analog outputs (user-assignable outputs)		
49	AO0 Analog output 0	± 10 V, max. 2 mA short-circuit proof, resolution ± 15 bits
50	M Ground, analog	
51	AO1 Analog output 1	
52	M Ground, analog	
Connections for temperature sensor (motor interface 1)		
53	Temp 1	Sensor acc. to p50490
54	Temp 2 (sense cable)	The cable to the temperature sensor on the motor must be shielded and connected to ground at both ends.
55	Temp 3	The cables for the Temp 1 and Temp 3 connections to the temperature sensor must have approximately the same length. The sense cable (Temp 2) is used for compensating the cable resistances. If you are not using a sense cable, terminals 54 and 55 must be connected.
56	M Ground, analog	

Module C98043-A7125 Connector Board

More information

Free function blocks

Application, properties

Logic operations, which link several states (e.g. access control, plant status) to a control signal (e.g. ON command), is required for controlling the drive system in a wide variety of applications. Along with logic operations, a number of arithmetic operations and storing elements are becoming increasingly important in drive systems.

This functionality is available as function module "Free function blocks" (FBLOCKS) for SINAMICS DC MASTER and can be activated in the Control Unit (CUD). A detailed description is provided in the Function Manual "Free function blocks" (see catalog section "Services and documentation").

Configuring and use

The free function blocks are configured at the parameter level.

The following parameters are required for this:

- Input parameters (e.g. inputs I0 ... I3 for the AND function block)
- Output parameters (e.g. output Y for the numeric change-over switch)
- Adjustable parameters (e.g. pulse duration for pulse generator MFP)
- Runtime group (this includes the sampling time; the free function blocks are not computed in the factory setting)
- Run sequence within the runtime group

A parameter is assigned to each input, output, and setting variable. These can be accessed by means of the Advanced Operator Panel AOP30 or STARTER commissioning software. The free function blocks can be interconnected at the BICO level. The free function blocks do not support data set dependency.

More information (continued)

Range of blocks

The table below shows the range of free function blocks available. The special technical properties of the individual function blocks can be taken from the function block diagrams in Chapter 3 of the Function Manual.

Short name	Name of function block	Data type	Count per drive object
AND	AND function block	BOOL	4
OR	OR function block	BOOL	4
XOR	XOR function block	BOOL	4
NOT	Inverter	BOOL	4
ADD	Adder	REAL	2
SUB	Subtractor	REAL	2
MUL	Multiplier	REAL	2
DIV	Divider	REAL	2
AVA	Absolute value generator with sign evaluation	REAL	2
MFP	Pulse generator	BOOL	2
PCL	Pulse shortener	BOOL	2
PDE	ON delay	BOOL	2
PDF	OFF delay	BOOL	2
PST	Pulse stretcher	BOOL	2
RSR	RS flip-flop, reset dominant	BOOL	2
DFR	D flip-flop, reset dominant	BOOL	2
BSW	Binary change-over switch	BOOL	2
NSW	Numeric change-over switch	REAL	2
LIM	Limiter	REAL	2
PT1	Smoothing element	REAL	2
INT	Integrator	REAL	1
DIF	Derivative-action element	REAL	1
LVM	Double-sided limit monitor with hysteresis	BOOL	2

Drive Control Chart (DCC)

The "Drive Control Chart" function (DCC) is available for more complex applications.

DCC allows you to graphically configure the required functionality and then download it to the drive. It provides a significantly extended range of block types available.

In online operation, the signal values can be monitored in STARTER/SCOUT in the DCC chart.

Power section and cooling

SINAMICS DC MASTER converters distinguish themselves as a result of the compact, space-saving design. The electronics module (available in various customer-specific combinations with options) is installed in a cradle that can be swiveled out. The easy access to individual components makes this technology very service-friendly.

Plug-in terminals are used to connect external signals (binary inputs/outputs, analog inputs/outputs, pulse generators etc.). The device software is saved in a flash EPROM and can be easily exchanged by loading via the serial interface of the SINAMICS DC MASTER.

Power section: Armature and field circuit

The armature circuit is implemented as a three-phase bridge circuit:

- For units for two-quadrant operation, in a fully-controlled three-phase bridge circuit B6C
- For units for four-quadrant operation in two fully-controlled three-phase bridge circuits (B6) A (B6) C.

The field circuit is implemented in a half-controlled single-phase bridge circuit B2HZ.

In the case of units with a 15 A to 1 200 A rated DC current, the power sections for the armature and field include electrically isolated thyristor modules, which means that the heat sink is floating. For units up to 30 A, the armature and field power sections are implemented in the form of a printed circuit board with compact modules that are soldered on.

For units with rated currents $\geq 1\,500$ A, the power section for the armature circuit uses disc-type thyristors and heat sinks at voltage potential. For units from 1 500 to 3 000 A, the thyristor phases are implemented as plug-in modules and can therefore be quickly replaced.

Checking the motor insulation has been significantly simplified due to the fact that the line supply voltage sensing for the armature and the field sections is electrically isolated.

Cooling

Units with a rated DC current up to 125 A are designed for natural air cooling, units with a rated current above 210 A are designed for forced air cooling (fan). The fans are always horizontally mounted at the top so that they can be quickly replaced without having to disconnect the power connections.

Parameterizing devices

BOP20 Basic Operator Panel



BOP20 Basic Operator Panel

As standard, all of the units are equipped with a BOP20 Basic Operator Panel from the SINAMICS family.

The basic operator panel offers customers a basic functionality for commissioning as well as operator control and monitoring.

Faults can be acknowledged, parameters set and diagnostics information read-out (e.g. alarm and fault messages) using the BOP20.

The BOP20 has a backlit two-line display area and 6 keys.

The BOP20 power supply and communication with the CUD Control Unit are established via the connector integrated at the rear of the BOP20.

SINAMICS DCM

DC Converter and Control Module

DC Converter

More information (continued)

AOP30 Advanced Operator Panel



The AOP30 Advanced Operator Panel is an optional input/output device for SINAMICS DC MASTER converters. It can be separately ordered. Additional information on the AOP30 is available in the catalog section “Accessories and supplementary components”.

PC based parameterization

The STARTER tool is available for PC-based commissioning and diagnostics. More detailed information is provided in catalog section 5 “Tools and engineering”.

Closed-loop control and open-loop drive control

The closed-loop and open-loop drive control is essentially designed for supplying the armature and field of variable-speed DC drives.

Using BICO technology permits the closed-loop and open-loop drive control structure to be simply adapted to the application-specific requirements as well as the use in alternative applications (e.g. as excitation equipment for synchronous motors).

The most important functions of the closed-loop control include:

- Setpoint processing (including digital setpoints, jogging, motorized potentiometer)
- Ramp-function generator
- Speed controller actual value processing
- Speed controller
- Torque and armature current control
- Closed-loop armature current control
- Armature gating unit
- Closed-loop EMF control
- Closed-loop field current control
- Field gating unit

BICO technology

BICO technology (Binector Connector Technology) allows signal paths to be defined (and therefore the controller structure) using parameters.

Mode of operation:

All important points of the closed-loop control are accessible via connectors.

Connectors are measuring points that are mapped to display parameters.

Important connectors include:

- Analog inputs and outputs
- Interface inputs (e.g. PROFIBUS)
- Actual value sensing inputs (e.g. speed, armature current, armature voltage)
- Inputs and outputs of the ramp-function generator, speed controller, armature current controller, armature gating unit, EMF controller, field current controller, field gating unit
- General quantities such as operating state, motor temperature rise, thyristor temperature rise

All important binary signals of the closed-loop and open-loop control are accessible via binectors.

Binectors are measuring points for binary signals, which are mapped to display parameters.

Important binectors include:

- Status of binary inputs
- Control words, status words
- Status of controllers, limits, faults

All of the important inputs of the open-loop and closed-loop control can be interconnected using BICO selection parameters. This means that by setting the corresponding BICO selection parameter, a connection can be established between any connector or binector.

Important inputs include:

- Setpoint input, supplementary setpoint input
- Ramp-function generator input
- Speed controller input
- Armature current controller input
- Armature gating unit input
- Speed setpoint limiting (before and after the ramp-function generator)
- Torque limiting
- Armature current limiting
- Signal source for binary and analog outputs

More information (continued)

Data sets

Many open-loop and closed-loop control parameters depend on the particular data set. This means that they have several indices where various values can be set. All data set dependent parameters can be simultaneously switched over to another data set using binary control signals.

There are two groups of data set-dependent parameters:

- **DDS parameters:**
Parameters that are associated with the drive data set (DDS). The drive data set contains various adjustable parameters that are relevant for open-loop and closed-loop drive control.
- **CDS parameters:**
Parameters that are associated with the command data set (CDS). Many BICO selection parameters are combined in the command data set. These parameters are used to interconnect the signal sources of a drive.

By parameterizing several command data sets and switching between them, the drive can be operated with different pre-configured signal sources.

Optimization run

The SINAMICS DC MASTER converter units are supplied with the factory settings. Controller setting is supported by selecting automatic optimization runs. The selection is made using special key numbers.

The following controller functions can be set using an automatic optimization run:

- Current controller optimization run to set the current controller and pre-controls (armature and field circuit).
- Speed controller optimization run to set the speed controller characteristics; the friction and moment of inertia compensation for the speed controller pre-control is automatically recorded.
- Automatic recording of the field characteristic for an EMF-dependent field-weakening control and automatic optimization of the EMF controller for field-weakening operation.
- In addition, all of the parameters set during the automatic optimization runs can be changed via the operator panel.

Monitoring and diagnostics

Displaying operating values

The operating state of the converter is displayed using a parameter. Several hundred signals can be displayed via parameter or selected for output on the display unit. Examples of measured values that can be displayed: Setpoints, actual values, status of binary inputs/outputs, line supply voltage, line frequency, firing angle, inputs/outputs of the analog terminals, controller input and output, limits.

Trace function

Up to eight measured quantities can be saved by selecting the trace function. A measured quantity or the occurrence of a fault message can be parameterized as trigger condition. By selecting a trigger delay, it is also possible to record (trace) the pre-history and post-history of events. The sampling time of the measured value storage can be parameterized.

The measured values can be output via the serial interfaces using the STARTER commissioning tool.

Fault messages

A number is assigned to each fault message. In addition, the operating hour of the event is saved together with the fault message. This allows the cause of the fault to be quickly pinpointed. By using the optional AOP30 Advanced Operator Panel, fault messages can be stamped in real time. Then, instead of the operating hour of the event, the day and the time of day of the event are displayed in the AOP30 fault list. For diagnostic purposes, the last eight fault messages are saved with fault number, fault value and the operating hours.

When a fault occurs

- the binary output function "Fault" is set to LOW (user-assignable function),
- the drive is switched-off (controller inhibit, current $I = 0$ is entered, pulses are inhibited, the relay "line contactor CLOSE" drops out) and
- an F is displayed with fault number, LED "Fault" is lit.

Fault messages should either be acknowledged via the operator panel, a binary user-assignable terminal or a serial interface. The "switch-on inhibit" state is reached after the fault has been acknowledged. "Switch-on inhibit" is canceled by an OFF command.

Automatic restart: An automatic restart is possible within a time that can be parameterized between 0 and 10 s. If the time is set to zero, a fault message is immediately output (for power failure) without a restart. A restart can be selected for the following fault messages: Phase failure (field or armature), undervoltage, overvoltage, electronics power supply failure, undervoltage condition at the parallel SINAMICS DC MASTER.

A distinction is made between the following groups of fault messages:

- **Power system faults:** Phase failure, fault in the field circuit, undervoltage, overvoltage, line frequency < 45 or > 65 Hz
- **Interface faults:** CUD interfaces or interfaces to the supplementary modules faulted
- **Drive faults:**
Controller monitoring for speed controller,
Current controller, EMF controller,
Field current controller has responded,
Drive stalled,
No armature current possible
- **Electronic motor overload protection**
(I^2t monitoring of the motor has responded)
- Tachometer monitoring and overspeed signal
- Commissioning fault
- Fault on the electronics module
- Fault message from the thyristor check: This fault message can only occur if the thyristor check has been activated using the appropriate parameter. In this case, a check is made as to whether the thyristors can be blocked and whether they can be fired.
- Fault messages from the motor sensor system:
Monitoring of brush length, bearing condition, air flow, motor temperature
- External faults via binary user-assignable terminals

The fault messages can be individually deactivated using a parameter. Some fault messages are already deactivated in the factory and can be activated using this parameter.

SINAMICS DCM

DC Converter and Control Module

DC Converter

More information (continued)

Alarms

Alarm messages display special states; however, they do not cause the drive to be switched-off. Alarms that occur do not have to be acknowledged, but rather they are automatically reset as soon as the cause of the alarm is no longer present.

When one or several alarms occur

- the binary output function "Alarm" must be set to LOW (user-assignable function) and
- the alarm is displayed by the flashing "Fault" LED.

A distinction is made between the following groups of alarms:

- Motor overtemperature: The calculated $\beta^2 t$ value of the motor has reached 100 %.
- Alarms from the motor sensor system: Monitoring of brush length, bearing condition, motor fan, motor temperature
- Drive alarms: Drive has stalled, no armature current possible
- External alarms via binary user-assignable terminals
- Alarms from supplementary modules

Functions of the inputs and outputs

Analog user-assignable inputs

After converting to a digital value, the quantity of the analog inputs can be flexibly adapted via parameters for scaling, filter, sign selection and offset input. The values are available as connector. This is the reason that the analog inputs can be effective as main setpoint and also as quantity for a supplementary setpoint or a limit.

Analog outputs

Selectable analog outputs are available to output analog signals. Analog signals can be output as bipolar signal or as absolute value. In this case, scaling, an offset, polarity and a filter time can be parameterized. The required output quantities are selected at the intervention points by entering connector numbers. For instance, speed actual value, ramp-function generator output, current setpoint, line supply voltage etc. can be output.

Binary inputs

- *Switch-on/shutdown (OFF 1)*
This terminal function is ANDed with the control bit of the serial interface. For an H signal at terminal *switch-on/shutdown*, the main contactor closes via an internal sequence control. The controllers are enabled if there is an H signal at the operating enable terminal. The drive accelerates up to the operating speed with the speed setpoint. For an L signal at the terminal *switch-on/shutdown*, the drive is ramp-down to speed $n < n_{\min}$ via the ramp-function generator; after the brake control delay time, the controllers are inhibited and at $l = 0$, the main contactor is opened. After this, after an adjustable time after the main contactor has dropped-out, the field current is reduced to the standstill field current (this can be parameterized). The standstill field can e.g. be used as anti-condensation heating for the motor; to do this, approximately 30 % of the rated field current must be entered as standstill field. The motor fan must be operational for a field current of 100 % of the rated field current. Otherwise, the field winding will be overloaded.
- *Operating enable*
This function is ANDed with the control bit of the serial interface. The controllers are enabled with an H signal at the *operating enable* terminal. For an L signal, the controllers are inhibited and at $l = 0$, the pulses are inhibited. The signal *operating enable* has a high priority; this means that if the signal (L signal) is withdrawn in operation, then this always results in $l = 0$ and therefore the drive coasts down.

Binary user-assignable inputs:

Additional binary input terminals are available for user-assignable functions. In this case, a binector number is assigned to every user-assignable terminal, which can be used for control functions.

Examples of binary input functions:

- Voltage disconnect (OFF 2): For OFF 2 (L signal), the controllers are instantaneously inhibited, the current in the armature circuit is reduced and at $l = 0$, the main contactor is opened. The drive coasts down uncontrolled.
- Fast stop (OFF 3): For a fast stop (L signal), the speed setpoint at the speed controller input is set to zero and the drive is braked along the current limit for the fast stop which can be parameterized. At $n < n_{\min}$ after the brake control delay time $l = 0$ is entered and the main contactor is opened.
- Jogging: The jogging function is available for an L signal at terminal *switch-on/shutdown*, for an H signal at terminal *operating enable* and when the jogging function is controlled. In this case, the main contactor is closed and the drive accelerates up to the jogging setpoint defined in a parameter. When the jogging signal is withdrawn, the drive is braked to $n < n_{\min}$; after this, the controllers are inhibited and the main contactor is opened after a parameterizable time (0 to 60 s). Further, it can be selected as to whether the ramp-function generator is active or ramp-up time=ramp-down time=0 is used.

Binary outputs

User-assignable signaling functions are available at the binary output terminals (open emitter output). Any binector quantity, which can be selected via the associated user-assignable parameter, can be output for each terminal. The polarity of the output signal and an adjustable delay time (0 to 10 s) can be selected using parameters.

Examples of binary output functions:

- Fault: An L signal is output when a fault message is present.
- $n < n_{\min}$: An H signal is output for speeds less than n_{\min} . This signal is used, for instance, as a zero speed signal.
- Switch-on command for a mechanical brake: A motor brake can be controlled using this signal.

When switching on the drive using the "switch-on" function and entering "operating enable", an H signal is output to open the brake, in this case, the internal controller enable is delayed by a parameterizable time (wait for the mechanical brake opening time to expire). When shutting down the drive using the "shutdown" function or "fast stop", an L signal is output to close the brake when speed $n < n_{\min}$ is reached. At the same time, the internal controller enable is present for a parameterizable time (wait for the mechanical brake closing time to expire): When $l = 0$ is entered, the pulses are inhibited and the main contactor is opened.

An additional operating mode can be selected using the "close brake" signal (L signal at the binary user-assignable output). As a consequence, when the "internal controller inhibit" is present (the drive is in a no-current condition), the drive does not wait for the status $n < n_{\min}$, but the brake is already controlled (operating brake) at speeds greater than n_{\min} .

Internal control inhibit is present when a fault message occurs, when the voltage is disconnected or the operating enable – terminal *operating enable* – is withdrawn in operation.

More information (continued)

Safety shutdown (E-STOP)

The E-STOP function is used to open the relay contact for the main contactor control within approximately 15 ms independent of semiconductor components and the correct functioning of the CUD. If the CUD is operating correctly, entering $I = 0$ via the control ensures that the main contactor is switched in a no-current condition. The drive coasts down once E-STOP has been entered.

After the E-STOP has been reset, the drive goes into the "switch-on inhibit" operating state. This must be acknowledged by activating the "shutdown" function e.g. by opening terminal *switch-on/shutdown*.

Note:

The E-STOP function is not an EMERGENCY OFF function in the sense of EN 60204-1.

Serial interfaces

The following serial interfaces are available for each CUD:

- A serial interface on the Standard CUD and Advanced CUD for the USS protocol according to RS232 or RS485 to connect the optional AOP30 Advanced Operator Panel or for STARTER via a PC
- A serial interface at the terminals of the Standard CUD and Advanced CUD, RS485 two-wire or four-wire for a peer-to-peer connection
- PROFIBUS-DP as standard on the Standard CUD and Advanced CUD
- PROFINET via the CBE20 Communication Board on the Advanced CUD (option)
- DRIVE-CLiQ on Advanced CUD (option) to connect optional SINAMICS components SMC30, TM15 and TM31

Physics of the interfaces

- RS232: ± 5 V interface for the point-to-point connection
- RS485: 3.3 V common mode interface, interference-proof, additionally for one bus connection with a maximum of 31 participants connected to the bus

USS protocol

Open Siemens protocol, can be simply programmed e.g. on the PC in third-party systems, any master interfaces can be used. The drives operate as slaves connected to a master. The drives are selected using a slave number.

The following data exchange is possible via the USS protocol:

- PKW data to read and write parameters
- PZD data (process data) such as control words, setpoints, status words, actual values

The send data (actual values) are selected by entering connector numbers in the parameters, the receive data (setpoints) represent the connector numbers, that can act at any intervention points.

Peer-to-peer protocol

The peer-to-peer protocol is used to connect devices with one another. For this operating mode, data is exchanged between converters via a serial interface, e.g. to establish a setpoint cascade. By using a serial interface as four-conductor cable, data can be received from the previous unit that is then processed (e.g. by being multiplied) and then transferred to the following unit. Only one serial interface is used for this purpose.

The following data can be exchanged between converters:

- Sending control words and actual values.
- Receiving status words and setpoints.

In this case, up to five data words are transferred in both the send and receive directions. Data is exchanged via connector numbers and intervention points.

The serial interfaces can be simultaneously operated. A connection to the automation (USS protocol) can be established via the first interface for control, diagnostics and to enter the main setpoint. A second interface is used to realize a setpoint cascade function via the peer-to-peer protocol.

Control terminal block

Terminals on the CUD

- Reference voltage P10, 10 mA load rating, Reference voltage N10, 10 mA load rating
- 2 analog inputs via differential amplifier, resolution ± 14 bits
0 ... ± 10 V, 0 ... ± 20 mA, 4 ... 20 mA
- 1 analog input via differential amplifier, resolution ± 14 bits
0 ... ± 10 V
- 4 analog inputs via differential amplifier, resolution ± 11 bits
0 ... ± 10 V
- One analog input for motor temperature sensor via PT100, PTC or KTY84
- 2 analog outputs, referred to ground, 0 ... ± 10 V, ± 15 -bit resolution, max. 2 mA
- Pulse encoder evaluation for 5 or 24 V encoder, 2 tracks and zero mark, maximum frequency 300 kHz
- P15 power supply, 200 mA for a pulse encoder
- 4 binary inputs, referred to ground, 2 with selectable function
- 4 binary inputs/outputs, referred to ground, outputs with open emitter P24, 100 mA load rating
- 4 binary outputs, referred to ground, open emitter P24, 100 mA load rating
- One serial interface, RS485 two-wire or four-wire, max. 187.5 kBaud
- P24 power supply to control the binary inputs
- Terminals for equipment ground "digital" (e.g.: to connect the loads of the binary outputs)
- Terminals for equipment ground "analog" (e.g.: to connect the reference potentials of analog inputs)
- Connector to connect an AOP30
- Connector to connect a serial RS232 interface and a 5 V power supply, 300 mA (e.g.: for a pulse encoder)

Terminals on the gating module

- Analog tachometer 8 to 270 V for maximum speed
- E-STOP

SINAMICS DCM

DC Converter and Control Module

DC Converter

More information (continued)

Interface to the motor

Motor temperature monitoring

Either PTC thermistors or linear temperature sensors (KTY84-130) can be connected. One input is provided on the Standard CUD and one input on the Advanced CUD option for this purpose. An alarm or fault message can be parameterized for PTC thermistors. When using a KTY84-130, one threshold can be entered for an alarm and one threshold for shutdown (trip). The limit values are displayed and entered in °C.

In addition, a thermo switch can be evaluated by the Advanced CUD (option). A parameterizable alarm or fault message can be output when the thermo switch responds (this is a binary switching signal). The evaluation is realized via a binary user-assignable input.

Brush length monitoring

The brush length is monitored using a floating microswitch; the shortest brush is evaluated. If the useful brush life has expired, then the microswitch opens; an alarm or fault message can be parameterized. The evaluation is realized via a binary user-assignable input.

Monitoring the motor fan airflow

An airflow monitor is integrated in the airflow of the motor fan. When this responds, an alarm or fault message is issued. The evaluation is realized via a binary user-assignable input.

Siemens DC motors

Although the end of DC technology has been forecast now for many years, we will keep hold of our DC technology and it will remain in our portfolio. When all is said and done, DC motors have proven themselves in daily use for decades now and they are essentially indispensable.

In conjunction with the SINAMICS DC MASTER converters, they always form the ideal team – wherever favorably-priced drive technology and the highest degree of availability are demanded.

These motors can also be used where space is restricted thanks to their compact and modular design.

Further, an extensive range of equipment and devices for mounting on the motor is available. A wide range of monitoring and diagnostic options facilitate reliable and disturbance-free operation.

Detailed specifications regarding quality assurance and improvement are integrated in all of the various operations and processes – from motor development through to production and service. Quality management coordinates the interaction between all of the company processes to ensure error-free and smooth processes.

It goes without saying that our stringent quality requirements also apply to our suppliers. All of the suppliers must seamlessly integrate themselves into our quality management system.

The result: Only fault-free and high quality materials are released for use in our motor production.



Customer benefits:

- High power density with low envelope dimensions
- High degree of operational reliability and availability through a wide range of diagnostic features, in conjunction with the SINAMICS DC MASTER converter
- High thermal reserves for continuous and overload conditions as a result of the DURIGNIT 2000® insulation system
- Low losses through a very good efficiency
- Long brush lifetimes through an optimized current commutation system

Technical data

Power range	31.5 ... 1 610 kW
Rated armature voltage	420 ... 810 V DC
Field	Separately excited
Shaft heights	160 ... 630 mm
Number of poles	4- and 6-pole
Speed	Up to 4 500 rpm
Degree of protection	IP23 and IP54
Type of construction	IM B3, IM B35, IM V1 and others
Cooling method	IC06/IC17/IC37/IC A06 A66/IC W37 A86
Stator version	Fully laminated
Standards	IEC, EN, DIN, VDE
Operation	Converter operation, 2Q and 4Q, S1 – S9

Typical applications:

- Lift and cableway drives
- Rolling mill drives and winders
- Hoisting and travel gear drives for cranes
- Extruders in the plastics industry
- Drives for printing machines
- Drives for paper machines

Additional information on Siemens DC motors is available in the Internet under:

<http://www.automation.siemens.com/ld/dc-motor>

SINAMICS DCM

DC Converter and Control Module

Control Module

Application



The SINAMICS DC MASTER Control Module is mainly used for retrofitting and modernizing DC drives in existing plants and systems. In DC technology, there are many anterior plants and systems that cannot be connected to modern automation systems.

When such plants and systems are retrofitted or upgraded, the motor, mechanical system and power section are retained and only the closed-loop control section is replaced by a Control Module. As a consequence, an extremely favorably-priced modern DC drive is obtained with the full functional scope of the well-proven, fully digital units from the SINAMICS DC MASTER series.

The new system is adapted to the configuration of the existing components using simple parameterization.

The SINAMICS DC MASTER Control Module contains a power section for the field supply with a rated current of 40 A.

Design

The SINAMICS DC MASTER Control Module sets itself apart as a result of its compact, space-saving design. The compact design where all of the individual components are easily accessible offers a high degree of service friendliness.

In order to be able to optimally use the mounting and installation possibilities in the plant or system, the SINAMICS DC MASTER Control Module can be split depthwise. In addition, the PC boards for generating and distributing the firing pulses as well as for the fuse monitoring and voltage sensing can be implemented so that they can be mounted outside the unit close to the power section.

Alternatively, when commissioning the drive system with STARTER, the adaptations, settings and measured value displays required can be made using the Basic Operator Panel BOP20 or the Advanced Operator Panel AOP30.

The AOP30 offers a favorably-priced alternative to measuring equipment installed in the electrical cabinet.

The field is supplied from a single-phase, half-controlled bridge circuit B2HZ. The field power section is implemented using electrically insulated thyristor modules, which means that the heat-sink is floating.

SINAMICS DCM

DC Converter and Control Module

Control Module

Technical specifications

For general technical data, see section "DC Converters"

	Type	6RA8000-0MV62-0AA0
Rated armature supply voltage that can be sensed	V	50/125/250/575/1 000
Rated supply voltage, electronics power supply	V	24 DC (18 ... 30 V DC); $I_n = 5 \text{ A}$
Rated field supply voltage ¹⁾	V	480 V 2 AC (+10/-20 %)
Rated frequency	Hz	45 ... 65
Rated DC field voltage ¹⁾	V	Max. 390
Rated DC field current	A	40
Normal ambient temperature in operation	°C	0 ... +55
Dimensions		
• Width	mm	271
• Height	mm	388
• Depth	mm	253
Weight, approx.	kg	12

Selection and ordering data

Rated data		Control Module		Fuses
Armature circuit	Field circuit	Order No.	Order No.	Field circuit
Rated supply voltage ²⁾	Rated supply voltage ²⁾	Rated current	Type	Type
V	V	A		1 each
50/125/250/575/1 000 V 3 AC	480 V (+10/-20 %) 2 AC	40	6RA8000-0MV62-0AA0	3NE1802-0 ³⁾

Options

Note:

When ordering a unit with options, add the suffix "-Z" after the Order No. and then state the order code(s) for the desired option(s) after the suffix.

Example:

6RA8000-0MV62-0AA0-Z
G00+G20+L10+...

Available options

The following table provides an overview of the available options. Detailed descriptions of the options are provided in the section "Description of options".

Designation	Order code	Notes	Order No. for separate order	
			not coated	coated
CUD				
Standard CUD left	(Standard)	–	6RY1803-0AA00	6RY1803-0AA20
Advanced CUD left	G00	–	6RY1803-0AA05	6RY1803-0AA25
Standard CUD right	G10	This option requires an Advanced CUD left – order code G00	6RY1803-0AA00	6RY1803-0AA20
Advanced CUD right	G11	This option requires an Advanced CUD left – order code G00	6RY1803-0AA05	6RY1803-0AA25
Communication Board CBE20 left	G20	This option requires an Advanced CUD left – order code G00	–	6SL3055-0AA00-2EB0
Communication Board CBE20 right	G21	This option requires an Advanced CUD right – order code G11	–	6SL3055-0AA00-2EB0
Memory card left	S01	–	6RX1800-0AS01	–
Memory card right	S02	This option requires a Standard CUD right – order code G10 – or an Advanced CUD right – order code G11	6RX1800-0AS01	–
Field				
Field power section 1Q	(Standard)	–	– ⁴⁾	– ⁴⁾
Field power section 2Q	L11	–	– ⁴⁾	– ⁴⁾
Without field power section	L10	–	–	–
Additional options				
Coated PCBs	M08	–	–	–
Nickel-plated copper busbars	M10	–	–	–

¹⁾ The field supply voltage can lie below the rated field voltage (set using a parameter, input voltages of up to 85 V are permissible). The output voltage decreases accordingly. The specified DC output voltage can be reliably provided up to a 5 % undervoltage of the line supply voltage (rated field supply voltage).

²⁾ 50/60 Hz

³⁾ UL-recognized

⁴⁾ Available as spare part.

Accessories

The SINAMICS DC MASTER Control Module can be split up into several individual modules. These can be mounted separately from one another.

Optional, pre-fabricated cable sets are available to connect the individual modules. This means that the drive system can be quickly but also flexibly adapted to the plant or system configuration.

Description	Content	Connection	Order No.
Rear enclosure part including accessories for mounting the firing pulse transformer module and/or fuse monitoring module for a parallel connection	Set of loose parts		6RY1805-0CM00
Screws, stud bolts, and snap-on parts to externally mount module parts	Set of loose parts		6RY1807-0CM00
Pre-fabricated connection set ribbon cable: To connect the two cradles when separately mounted	2 x 26-core ribbon cable shielded (3 m long) 1 x 10-core ribbon cable shielded (3 m long) 1 x 20-core ribbon cable shielded (3 m long) 1 x RJ45 patch cable shielded (3 m long)	from X21A, X22A on PC board -A7109- to X21A, X22A on PC board -A7043- from X23B on PC board -A7109- to X23B on PC board -A7118- from XF1 on PC board -A7109- to XF1 on PC board -A7116- from X45 on PC board -A7109- to X45 on PC board -A7117-	6RY1707-0CM01
Pre-fabricated connection set ribbon cable: To connect the two cradles when separately mounted	2 x 26-core ribbon cable shielded (10 m long) 1 x 10-core ribbon cable shielded (10 m long) 1 x 20-core ribbon cable shielded (10 m long) 1 x RJ45 patch cable shielded (10 m long)	from X21A, X22A on PC board -A7109- to X21A, X22A on PC board -A7043- from X23B on PC board -A7109- to X23B on PC board -A7118- from XF1 on PC board -A7109- to XF1 on PC board -A7116- from X45 on PC board -A7109- to X45 on PC board -A7117-	6RY1807-0CM02
Pre-fabricated connection set for current transformer	2 x 2-core twisted cable (2 m long)	from XB on PC board -A7109- to the current transformers	6RY1707-0CM03 ¹⁾
Pre-fabricated connection set for current transformer	2 x 2-core cable shielded (10 m long)	from XB on PC board -A7109- to the current transformers	6RY1707-0CM04 ¹⁾
Pre-fabricated connection set for heatsink temperature sensing	1 x 2-core cable shielded (10 m long)	from XT6 on PC board -A7109- to temperature sensor on the heat sink	6RY1707-0CM05
Pre-fabricated connection set for firing pulse cables	Connection set for 12 x 2-core twisted cable (3 m long)	from XIMP11, XIMP12, XIMP13, XIMP14, XIMP15, XIMP16, XIMP21, XIMP22, XIMP23, XIMP24, XIMP25, XIMP26 to the thyristors	6RY1707-0CM06 ¹⁾
Pre-fabricated connection set for fuse monitoring	6 x 2-core twisted cable (10 m long)	from XS1_5, XS2_5, XS3_5, XS4_5, XS5_5, XS6_5, XS7_5, XS8_5, XS9_5, XS10_5, XS11_5, XS12_5 or XS1_4, XS2_4, XS3_4, XS4_4, XS5_4, XS6_4, XS7_4, XS8_4, XS9_4, XS10_4, XS11_4, XS12_4 or XS1_3, XS2_3, XS3_3, XS4_3, XS5_3, XS6_3, XS7_3, XS8_3, XS9_3, XS10_3	6RY1807-0CM07
Pre-fabricated connection set for voltage sensing	1 x 3-core twisted cable U-V-W (3 m long) 1 x 2-core twisted cable C-D (3 m long)	from XU6, XV6, XW6 or XU5, XV5, XW5 or XU4, XV4, XW4 or XU3, XV3, XW3 or XU2, XV2, XW2 or XU1, XV1, XW1 depending on the voltage (5.6 V, 50 V, 125 V, 250 V, 575 V or 1000 V) to supply XC6, XD6 or XC5, XD5 or XC4, XD4 or XC3, XD3 or XC2, XD2	6RY1807-0CM08
Pre-fabricated connection set for controlling the firing pulse transformers	12 x 2-core twisted cable (1 m long)	from XIMP1, XIMP4 or XIMP2, XIMP5 or XIMP3, XIMP6 on PC board -A7043- (side parts) on the firing pulse transformer modules (single boards) with the terminals X11, X12, X13, X14, X15, X16, X21, X22, X23, X24, X25, X26	6RY1707-0CM13 ¹⁾
Pre-fabricated connection set for controlling the firing pulse transformers	2 x 12-core cable shielded (10 m long)	from XIMP1, XIMP4 and/or XIMP2, XIMP5 and/or XIMP3, XIMP6 on PC board -A7043- to the external firing pulse transformers	6RY1707-0CM10 ¹⁾
Pre-fabricated connection set for mounting cradles next to each other	2 x 26-core ribbon cable shielded (10 m long) 1 x 10-core ribbon cable shielded (10 m long) 1 x 20-core ribbon cable shielded (10 m long) 1 x RJ45 patch cable shielded (10 m long)	from X21A, X22A on PC board -A7109- to X21A, X22A on PC board -A7043- from X23B on PC board -A7109- to X23B on PC board -A7118- from XF1 on PC board -A7109- to XF1 on PC board -A7116- from X45 on PC board -A7109- to X45 on PC board -A7117-	6RY1807-0CM11

¹⁾ Unchanged when compared to the SIMOREG DC-MASTER Control Modules.

SINAMICS DCM DC Converter and Control Module

Control Module

Schematics

3

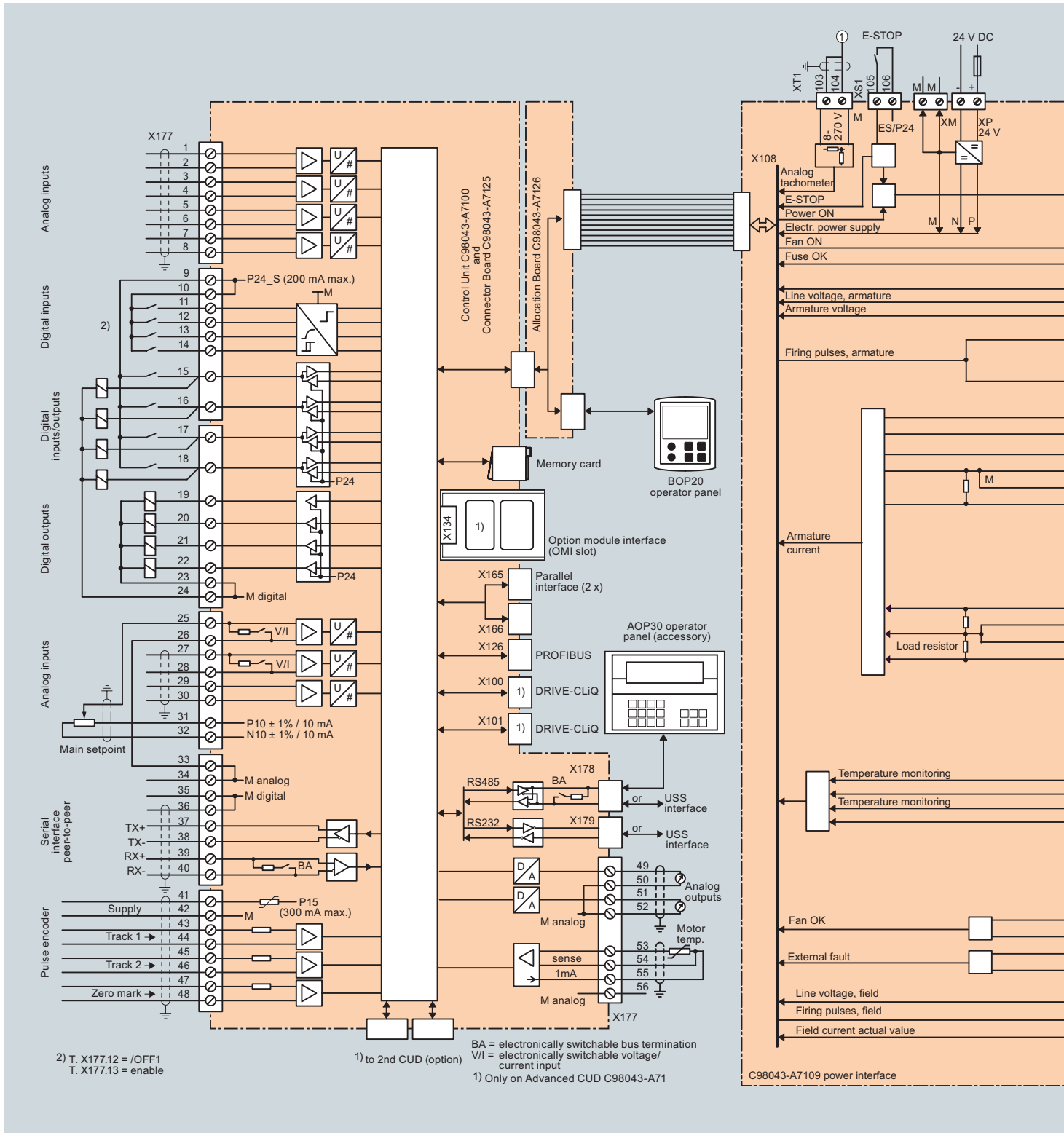

Schematics (continued)

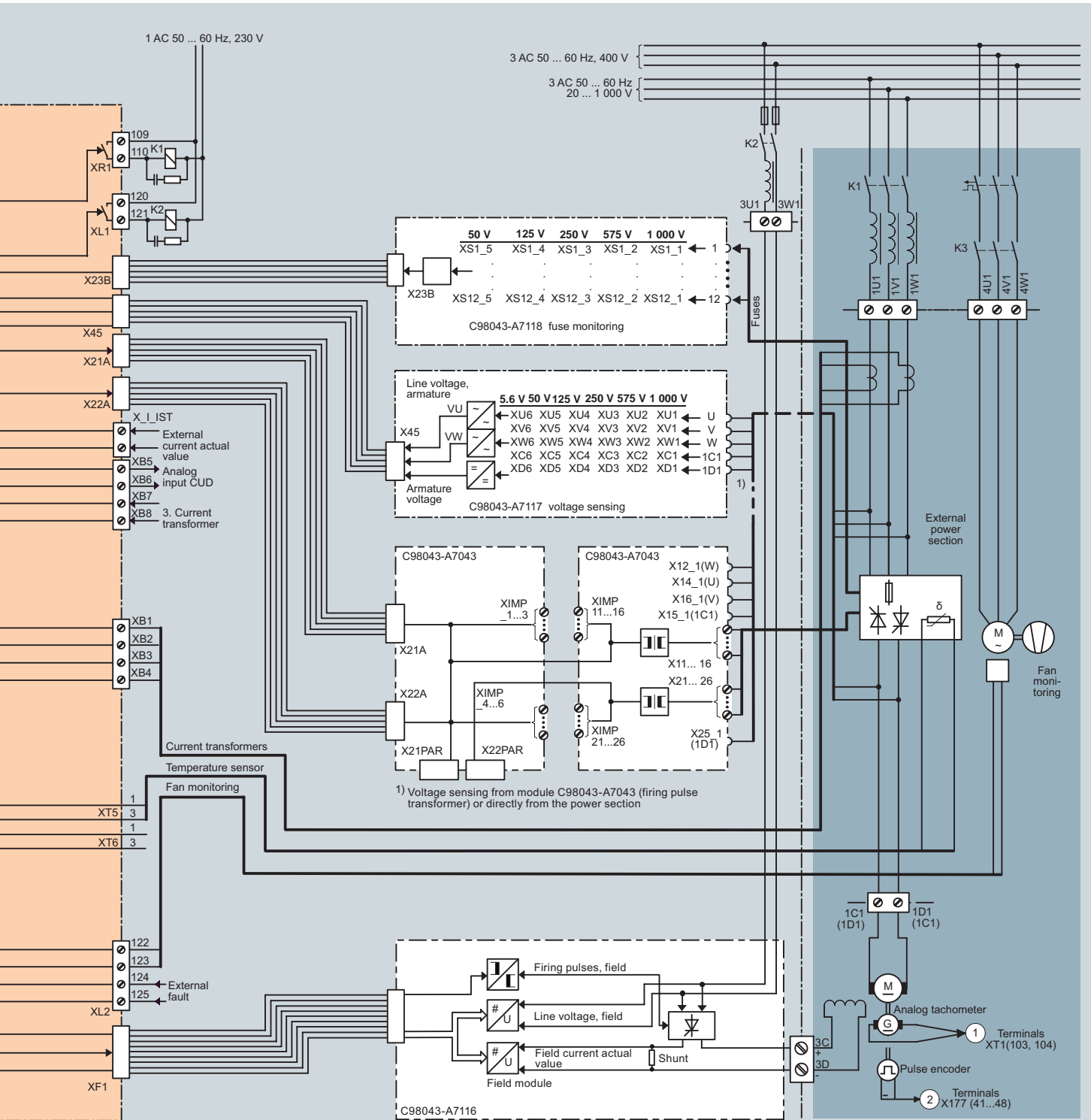

G_D023_EN_00069

SINAMICS DCM

DC Converter and Control Module

Notes

3

Accessories and supplementary components



4/2 AOP30 Advanced Operator Panel

- 4/2 Overview
- 4/3 Function
- 4/3 Selection and ordering data

4/4 SMC30 Sensor Module Cabinet-Mounted

- 4/4 Overview
- 4/4 Design
- 4/4 Integration
- 4/4 Technical specifications
- 4/4 Selection and ordering data
- 4/4
 - SMC30 Sensor Module Cabinet-Mounted
 - DRIVE-CLiQ cables

4/5 TM15 Terminal Module

- 4/5 Overview
- 4/5 Design
- 4/6 Integration
- 4/7 Technical specifications
- 4/7 Selection and ordering data
- 4/7
 - TM15 Terminal Module
 - DRIVE-CLiQ cables

4/8 TM31 Terminal Module

- 4/8 Overview
- 4/8 Design
- 4/9 Integration
- 4/10 Technical specifications
- 4/10 Selection and ordering data
- 4/10
 - TM31 Terminal Module
 - DRIVE-CLiQ cables

4/11 Mounting kit to upgrade to IP20

- 4/11 Overview
- 4/11 Selection and ordering data

4/12 Line fuses

- 4/12 Overview
- 4/12 Selection and ordering data
- 4/12
 - Fuses for the field circuit
 - Fuses for the armature circuit

4/16 Commutating reactors

- 4/16 Overview
- 4/17 Selection and ordering data

4/19 Circuit-breakers and contactors

- 4/19 Overview
- 4/19
 - Selection criteria

4/19 Radio interference suppression filters

- 4/19 Overview
- 4/19
 - List of the recommended radio interference suppression filters from EPCOS
 - List of the recommended radio interference suppression filters from Siemens
- 4/20 Technical specifications

4/21 SICROWBAR AC overvoltage protection

- 4/21 Application
- 4/21 Design
- 4/21 Mode of operation
- 4/21 Configuration
- 4/22 Technical specifications
- 4/23 Selection and ordering data
- 4/23 Accessories

4/24 SICROWBAR DC overvoltage protection

- 4/24 Application
- 4/24 Design
- 4/24 Mode of operation
- 4/25 Configuration
- 4/26 Technical specifications
- 4/27 Selection and ordering data
- 4/27 Accessories
- 4/27 Options

4/28 SIMOREG CCP

- 4/28 Overview
- 4/28 Benefits
- 4/28 Design
- 4/28 Function
- 4/29 Integration
- 4/30 Technical specifications
- 4/31 Selection and ordering data
- 4/31 Accessories
- 4/32 Schematics

SINAMICS DCM

Accessories and supplementary components

AOP30 Advanced Operator Panel

Overview



The AOP30 Advanced Operator Panel is an optional input/output device for SINAMICS DC MASTER converters. It can be separately ordered. The operator panel is only designed for installation outside the converter (e.g. in a cabinet door up to 4 mm thick), installation cut-out 141.5 × 197.5 mm.

It sets itself apart as a result of the following properties:

- Graphic LCD display (240 × 64 pixels) with backlighting for plain-text display and a bar-type display for process variables
- LEDs for displaying the operating states
 - RUN green
 - ALARM yellow
 - FAULT red
- Help function describing the causes of faults and alarms and how to resolve them
- Time and date memory with internal battery backup
- 26-key membrane keyboard
 - Keypad for operational control of a drive
 - Local/remote switchover for selecting the operator control location (operator panel or customer terminal strip/communications channel has the control authority)
 - Numeric keypad for entering setpoints or parameter values
 - Function keys for prompted navigation in the menu
- RS232 and RS485 interface
- Connection for a 24 V power supply
- The converter can be controlled using the AOP30 up to distances of 200 m. A cable with integrated 24 V power supply in standard lengths can be ordered as accessory.
- Two-stage safety strategy to protect against accidental or unauthorized changes to settings.
 - Operation of the drive from the operator panel can be disabled using the control inhibit function so that only parameter values and process variables can be displayed on the operating panel.
 - A password can be used to prevent converter parameters being changed by unauthorized personnel.
- Front panel with degree of protection IP55, rear IP20

The AOP30 communicates with the SINAMICS DC MASTER drive via the serial RS485 interface.

The AOP30 can communicate with the Standard CUD as well as with the Advanced CUD of the SINAMICS DC MASTER.

A 24 V power supply is required to operate the AOP30. For a maximum cable length of 50 m, this can be taken from the CUD of the SINAMICS DC MASTER. An external power supply must be used for cable lengths greater than 50 m.

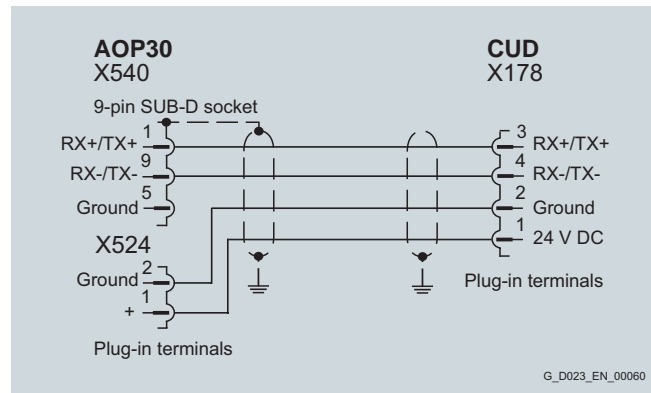

Assignment of the RS485 cable with a 24 V power supply from the CUD – max. cable length 50 m

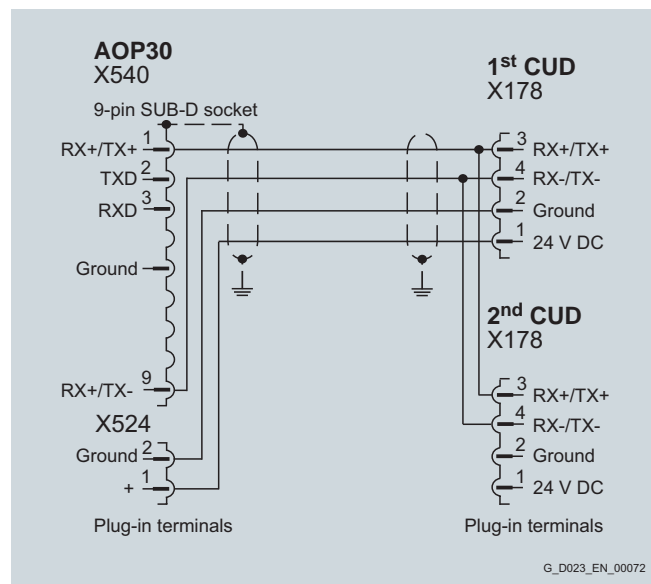

Assignment of the RS485 cable when using two CUDs (24 V power supply from one CUD) – max. cable length 50 m

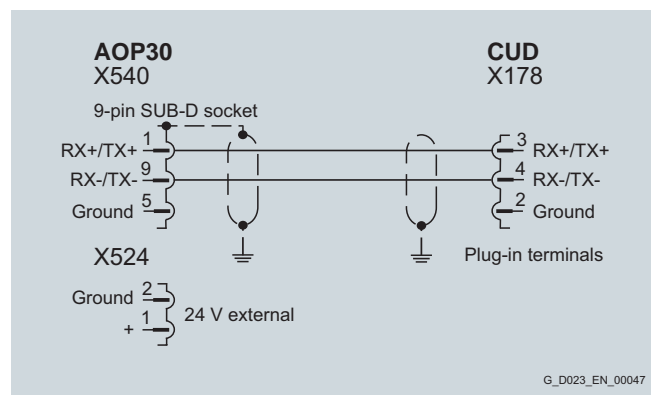

Assignment of the RS485 cable when supplying the AOP30 from an external 24 V DC source – max. cable length 200 m

Overview (continued)

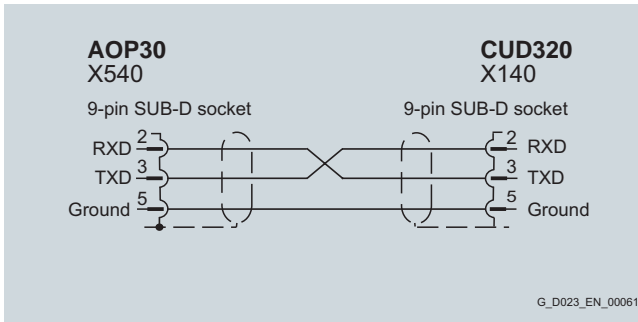

Assignment of the RS232 cable for connecting to an AC SINAMICS unit (not for SINAMICS DC MASTER!)

Function

The current operating states, setpoints and actual values, parameters, indices, faults and alarms are displayed on the display panel.

German and English are integrated in the SINAMICS DC MASTER as standard. Additional languages, if the memory card with a corresponding language package is inserted in every CUD.

Note:

Only operator panels with Order No. 6SL3055-0AA00-4CA4 have a second RS485 interface. Preliminary models are not suitable for SINAMICS DC MASTER.

Selection and ordering data

Description	Order No.
AOP30 Advanced Operator Panel	6SL3055-0AA00-4CA4

A connecting cable with integrated 24 V power supply is available to connect the AOP via RS485.

RS485 cable to connect the AOP	Length m	Order No.
to a CUD	3	6RY1807-0AP00
to two CUDs	3	6RY1807-0AP10

Other cable lengths can be ordered by specifying the following options.

Cable length	Order code
5 m	K05
10 m	K10
15 m	K15
20 m	K20
25 m	K25
30 m	K30
35 m	K35
40 m	K40
45 m	K45
50 m	K50

Note:

When ordering the RS485 cable with options, add the suffix "**-Z**" after the Order No. and then state the order code for the desired option after the suffix.

Ordering example for 35 m cable length: **6RY1807-0AP00-Z K35**

SINAMICS DCM

Accessories and supplementary components

SMC30 Sensor Module Cabinet-Mounted

Overview



Every CUD (both Standard CUD as well as also Advanced CUD) can evaluate the signals of an incremental encoder. For applications where more than one encoder must be evaluated, either a second CUD and/or the SMC30 Sensor Module Cabinet-Mounted can be used.

The SMC30 can be used to evaluate SSI encoders with incremental signals, which for instance, are used for positioning functions.

Encoders, which have a DRIVE-CLiQ interface, cannot be evaluated at the SINAMICS DC MASTER or at the SMC30. These encoders are usually not used in the DC drive technology.

The following encoder signals can be evaluated:

- Incremental encoders TTL/HTL with and without broken cable detection (broken cable detection is only available with bipolar signals)
- SSI encoder with TTL/HTL incremental signals
- SSI encoder without incremental signals

The motor temperature input, available on the SMC30, is not evaluated for SINAMICS DC MASTER. A motor temperature sensor can be evaluated using the temperature measurement input provided on each CUD.

Design

The SMC30 Sensor Module Cabinet-Mounted features the following interfaces as standard:

- 1 DRIVE-CLiQ interface
- 1 encoder connection via Sub-D connector or terminals
- 1 connection for the electronics power supply via the 24 V DC power supply connector
- 1 PE/protective conductor connection

The status of the SMC30 Sensor Module Cabinet-Mounted is indicated using a multi-color LED.

The SMC30 Sensor Module Cabinet-Mounted can be snapped on a TH mounting rail in accordance with EN 60715 (IEC 60715).

The maximum encoder cable length between SMC30 modules and encoders is 100 m. For HTL encoders, this length can be increased to 300 m if the A+/A- and B+/B- signals are evaluated and the power supply cable has a minimum cross section of 0.5 mm².

The signal cable shield can be connected to the SMC30 Sensor Module Cabinet-Mounted via a shield connection terminal, e.g. Phoenix Contact type SK8 or Weidmüller type KLBÜ CO 1.

Integration

The SMC30 Sensor Module Cabinet-Mounted communicates with the Advanced CUD via DRIVE-CLiQ. One SMC30 can be connected to each Advanced CUD.

Technical specifications

SMC30 Sensor Module Cabinet-Mounted	
Current consumption, max. at 24 V DC, not taking the encoder into account	0.2 A
• Conductor cross-section, max.	2.5 mm ²
• Fuse protection, max.	20 A
Power loss	< 10 W
Encoders that can be evaluated	<ul style="list-style-type: none"> • Incremental encoder TTL/HTL • SSI encoder with TTL/HTL incremental signals • SSI encoder without incremental signals
• Encoder supply	24 V DC/0.35 A or 5 V DC/0.35 A
• Encoder frequency, max.	300 kHz
• SSI baud rate	100 ... 250 kBaud
• Limiting frequency	300 kHz
• Resolution absolute position SSI	30 bits
• Cable length, max.	
- TTL encoder	100 m (only bipolar signals permitted) ¹⁾
- HTL encoder	100 m for unipolar signals 300 m for bipolar signals ¹⁾
- SSI encoder	100 m
PE connection	M4 screw
Dimensions	
• Width	30 mm
• Height	150 mm
• Depth	111 mm
Weight, approx.	0.45 kg
Approvals	cULus (File No.: E164110)

Selection and ordering data

Description	Order No.
SMC30 Sensor Module Cabinet-Mounted (without DRIVE-CLiQ cable)	6SL3055-0AA00-5CA2

Note:

The maximum permissible encoder currents should be carefully observed. The capacitive recharging currents increase in the connecting cable between the encoder and converter due to long cable lengths and high output frequencies. This can cause the output driver of the encoder to be overloaded and/or result in incorrect evaluation of the encoder signals. This is the reason that the encoder manufacturer's instructions must be carefully observed.

¹⁾ Twisted pair and shielded signal cables.

Selection and ordering data (continued)

DRIVE-CLiQ cables

Description	Length m	Order No.
Pre-fabricated DRIVE-CLiQ cable	0.11	6SL3060-4AB00-0AA0
Degree of protection of connector IP20/IP20	0.16	6SL3060-4AD00-0AA0
	0.21	6SL3060-4AF00-0AA0
	0.26	6SL3060-4AH00-0AA0
	0.36	6SL3060-4AM00-0AA0
	0.60	6SL3060-4AU00-0AA0
	0.95	6SL3060-4AA10-0AA0
	1.20	6SL3060-4AW00-0AA0
	1.45	6SL3060-4AF10-0AA0
	2.80	6SL3060-4AJ20-0AA0
	5.00	6SL3060-4AA50-0AA0

TM15 Terminal Module

Overview



The number of available digital inputs and outputs within a drive system can be expanded with the TM15 Terminal Module.

Design

The following are located on the TM15 Terminal Module:

- 24 bidirectional digital inputs/outputs (isolation in 3 groups with 8 channels each)
- 24 green status LEDs for indicating the logical signal status of the relevant terminal
- 2 DRIVE-CLiQ sockets
- 1 connection for the electronics power supply via the 24 V DC power supply connector
- 1 PE/protective conductor connection

The TM15 Terminal Module can be snapped on a TH 35 mounting rail in accordance with EN 60715 (IEC 60715).

The signal cable shield can be connected to the TM15 Terminal Module via a shield connection terminal, e.g. Phoenix Contact type SK8 or Weidmüller type KLBÜ CO 1. The shield connection terminal must not be used for strain relief.

The status of the TM15 Terminal Module is indicated via a multi-color LED.

SINAMICS DCM

Accessories and supplementary components

TM15 Terminal Module

Integration

The TM15 Terminal Module communicates with the Advanced CUD via DRIVE-CLiQ. Further, TM15 can also be used with the

CU310 and CU320 Control Units and a SIMOTION D Control Unit.

4

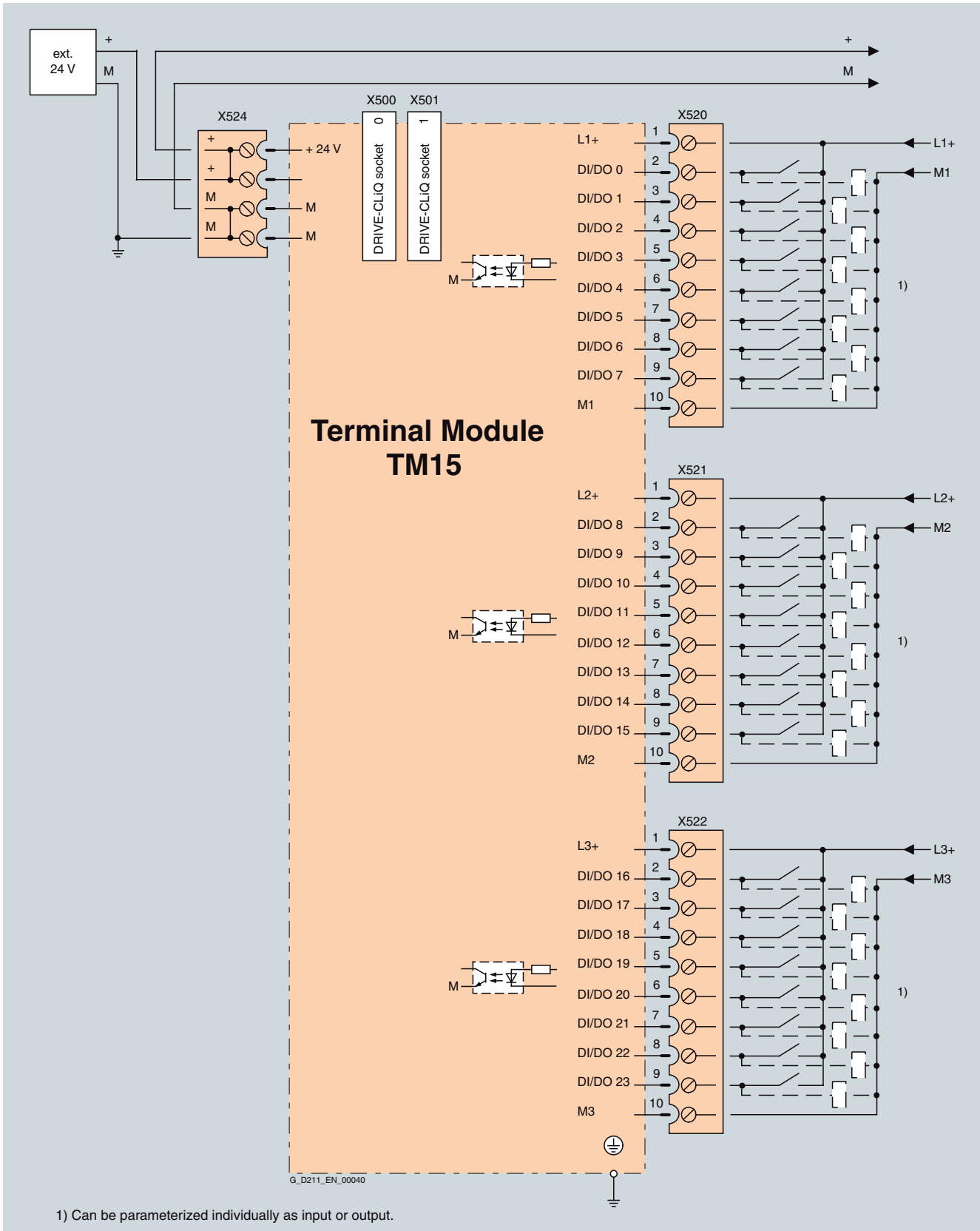

Connection example of a TM15 Terminal Module

SINAMICS DCM

Accessories and supplementary components

TM15 Terminal Module

Technical specifications

TM15 Terminal Module	
Current consumption, max. with 24 V DC without load	0.15 A
• Conductor cross-section, max.	2.5 mm ²
• Fuse protection, max.	20 A
Number of DRIVE-CLiQ sockets	2
I/O	
• Digital inputs/outputs	Channelwise parameterizable as DI or DO
• Number of digital inputs/outputs	24
• Electrical isolation	Yes, in groups of 8
• Connection system	Plug-in screw-type terminals
• Conductor cross-section, max.	1.5 mm ²
Digital inputs	
• Voltage	-30 ... +30 V
• Low level (an open digital input is interpreted as "low")	-30 ... +5 V
• High level	15 ... 30 V
• Current consumption at 24 V DC	5 ... 11 mA
• Delay times of digital inputs, typ. ¹⁾	
- L → H	50 μs
- H → L	100 μs
Digital outputs (continuously short-circuit-proof)	
• Voltage	24 V DC
• Load current per digital output, max.	0.5 A
• Delay times (ohmic load) ¹⁾	
- L → H, typ.	50 μs
- L → H, max.	100 μs
- H → L, typ.	150 μs
- H → L, max.	225 μs
• Total current of outputs (per group), max.	
- Up to 60 °C	2 A
- Up to 50 °C	3 A
- Up to 40 °C	4 A
Power loss	< 3 W
PE connection	M4 screw
Dimensions	
• Width	50 mm
• Height	150 mm
• Depth	111 mm
Weight, approx.	0.86 kg
Approvals	cULus (File No.: E164110)

Selection and ordering data

TM15 Terminal Module

Description	Order No.
TM15 Terminal Module (without DRIVE-CLiQ cable)	6SL3055-0AA00-3FA0

DRIVE-CLiQ cables

Description	Length m	Order No.
Pre-fabricated DRIVE-CLiQ cable	0.11	6SL3060-4AB00-0AA0
	0.16	6SL3060-4AD00-0AA0
Degree of protection of connector IP20/IP20	0.21	6SL3060-4AF00-0AA0
	0.26	6SL3060-4AH00-0AA0
	0.36	6SL3060-4AM00-0AA0
	0.60	6SL3060-4AU00-0AA0
	0.95	6SL3060-4AA10-0AA0
	1.20	6SL3060-4AW00-0AA0
	1.45	6SL3060-4AF10-0AA0
	2.80	6SL3060-4AJ20-0AA0
	5.00	6SL3060-4AA50-0AA0

¹⁾ The specified delay times refer to the hardware. The actual reaction time depends on the time slice in which the digital input/output is processed.

SINAMICS DCM

Accessories and supplementary components

TM31 Terminal Module

Overview



Using the TM31 Terminal Module, the number of available digital inputs and outputs and the number of analog inputs and outputs within a drive system can be expanded.

The TM31 Terminal Module also features relay outputs with changeover contact and a temperature sensor input.

4

Design

The following are located on the TM31 Terminal Module:

- 8 digital inputs
- 4 bidirectional digital inputs/outputs
- 2 relay outputs with changeover contact
- 2 analog inputs
- 2 analog outputs
- 1 temperature sensor input (KTY84-130 or PTC)
- 2 DRIVE-CLiQ sockets
- 1 connection for the electronics power supply via the 24 V DC power supply connector
- 1 PE/protective conductor connection

The TM31 Terminal Module can be snapped on a TH 35 mounting rail in accordance with EN 60715 (IEC 60715).

The signal cable shield can be connected to the TM31 Terminal Module via a shield connection terminal, e.g. Phoenix Contact type SK8 or Weidmüller type KLBÜ CO 1. The shield connection terminal must not be used for strain relief.

The status of the TM31 Terminal Module is indicated via a multi-color LED.

Integration

The TM31 Terminal Module communicates with the Advanced CUD via DRIVE-CLiQ.

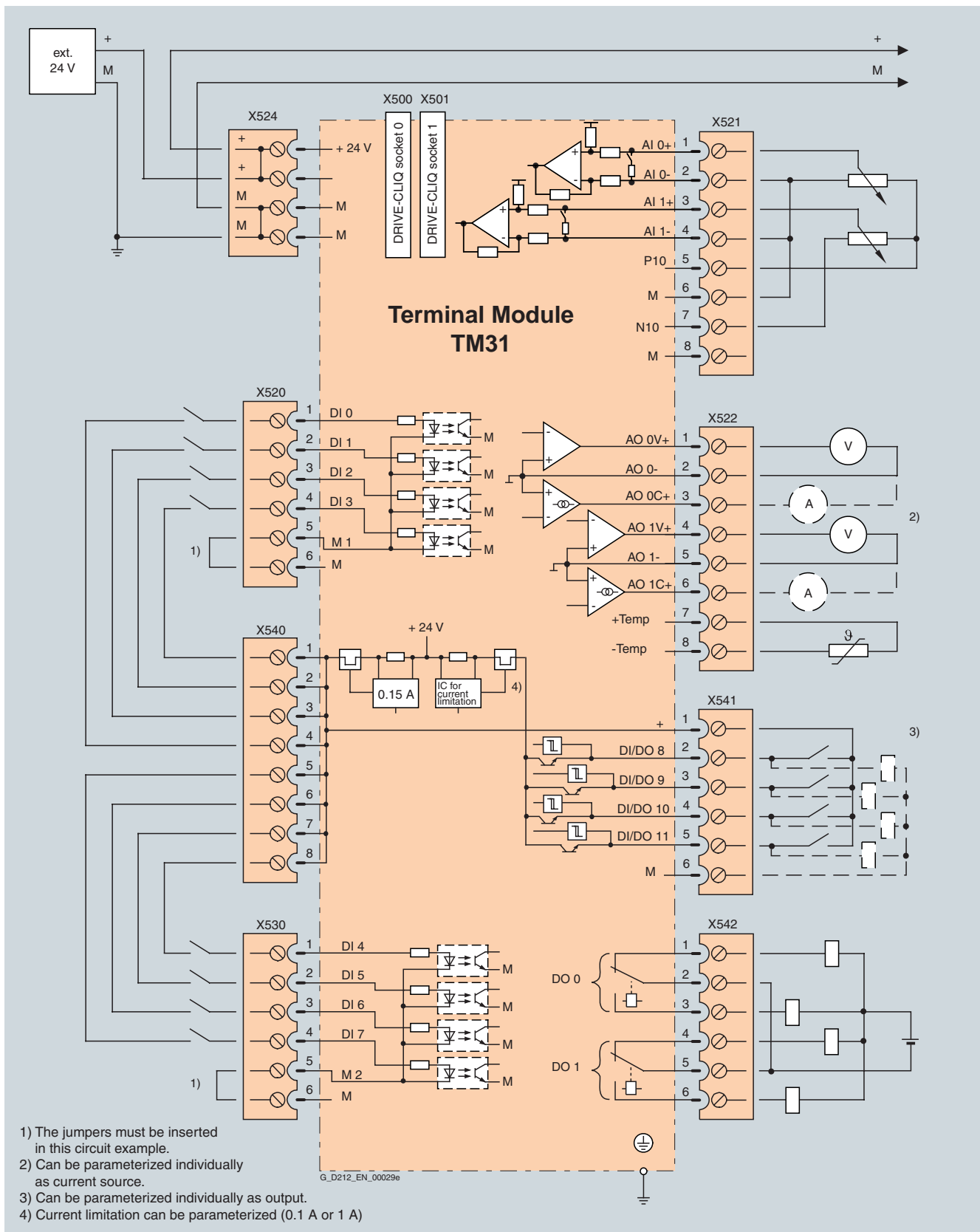

Connection example of a TM31 Terminal Module

TM31 Terminal Module

Technical specifications

TM31 Terminal Module	
Current consumption, max. At 24 V DC without taking into account the digital outputs and DRIVE-CLiQ supply	0.2 A
• Conductor cross-section, max.	2.5 mm ²
• Fuse protection, max.	20 A
Digital inputs	
• Voltage	-3 ... +30 V
• Low level (an open digital input is interpreted as "low")	-3 ... +5 V
• High level	15 ... 30 V
• Current consumption at 24 V DC, typ.	10 mA
• Delay times of digital inputs ¹⁾ , approx.	
- L → H	50 μs
- H → L	100 μs
• Conductor cross-section, max.	1.5 mm ²
Digital outputs (continuously short-circuit-proof)	
• Voltage	24 V DC
• Total current of digital outputs, max.	1 000 mA
• Delay times of digital outputs ¹⁾	
- typ.	150 μs with 0.5 A resistive load
- max.	500 μs
• Conductor cross-section, max.	1.5 mm ²
Analog inputs	
• As voltage input	
- Voltage range	-10 ... +10 V
- Internal resistance R_i	100 kΩ
• As current input	
- Current range	4 ... 20 mA, -20 ... +20 mA, 0 ... 20 mA
- Internal resistance R_i	250 Ω
- Resolution ²⁾	11 bits + sign
• Conductor cross-section, max.	1.5 mm ²

TM31 Terminal Module	
Analog outputs (continuously short-circuit-proof)	
• Voltage range	-10 ... +10 V
• Load current, max.	-3 ... +3 mA
• Current range	4 ... 20 mA, -20 ... +20 mA, 0 ... 20 mA
• Load resistance, max.	500 Ω for outputs in the range -20 ... +20 mA
• Resolution	11 bits + sign
• Conductor cross-section, max.	1.5 mm ²
Relay outputs (changeover contacts)	
• Load current, max.	8 A
• Switching voltage, max.	250 V AC, 30 V DC
• Switching capacity, max.	
- At 250 V AC	2 000 VA (cos φ = 1) 750 VA (cos φ = 0.4)
- At 30 V DC	240 W (resistive load)
• Required minimum current	100 mA
• Conductor cross-section, max.	2.5 mm ²
Power loss	< 10 W
PE connection	M4 screw
Dimensions	
• Width	50 mm
• Height	150 mm
• Depth	111 mm
Weight, approx.	0.87 kg
Approvals	cULus (File No.: 164110)

Selection and ordering data

Description	Order No.
TM31 Terminal Module (without DRIVE-CLiQ cable)	6SL3055-0AA00-3AA1

DRIVE-CLiQ cables

Description	Length m	Order No.
Pre-fabricated DRIVE-CLiQ cable	0.11	6SL3060-4AB00-0AA0
	0.16	6SL3060-4AD00-0AA0
Degree of protection of connector IP20/IP20	0.21	6SL3060-4AF00-0AA0
	0.26	6SL3060-4AH00-0AA0
	0.36	6SL3060-4AM00-0AA0
	0.60	6SL3060-4AU00-0AA0
	0.95	6SL3060-4AA10-0AA0
	1.20	6SL3060-4AW00-0AA0
	1.45	6SL3060-4AF10-0AA0
	2.80	6SL3060-4AJ20-0AA0
	5.00	6SL3060-4AA50-0AA0

¹⁾ The specified delay times refer to the hardware. The actual reaction time depends on the time slice in which the digital input is processed.

²⁾ If the analog input is to be operated in the signal processing sense with a continuously variable input voltage, the sampling frequency $f_a = 1/t_{\text{time slice}}$ must be at least twice the value of the highest signal frequency f_{max} .

SINAMICS DCM

Accessories and supplementary components

Mounting kit to upgrade to IP20

Overview

With a mounting kit, it is possible to increase the degree of protection of SINAMICS DC MASTER from IP00 up to IP20.

Selection and ordering data

For units up to 850 A, there is a suitable mounting kit to increase the degree of protection; this can be ordered using the following order numbers.

Mounting kit to upgrade to IP20	
Description	Order No.
for units from 15 to 30 A	6RX1800-0MA00
for units from 60 to 280 A	6RX1800-0MA01
for units from 400 to 600 A	6RX1800-0MA02
for units from 720 to 850 A	6RX1800-0MA03

SINAMICS DCM

Accessories and supplementary components

Line fuses

Overview

3NE1 SITOR double protection fuses allow the cable and semiconductor protection to be implemented with just one fuse.

This results in significant cost savings and shorter assembly times.

An overview of the fuses required for the armature and field circuits is provided in the following table.

Fuse	Armature circuit				Field circuit
	< 900 A		≥ 900A		
	Two-quadrant operation	Four-quadrant operation	Two-quadrant operation	Four-quadrant operation	
Phase fuse	Required	Required	–	–	Required
Arm fuse	–	–	Integrated in the unit	Integrated in the unit	–
DC fuse	–	Required	–	–	–

Selection and ordering data

For technical data, engineering data as well as dimension drawings for Siemens fuses, please refer to Catalog ET B1 "BETA Low-Voltage Switchgear and Controlgear" catalog section 4.

In order to ensure UL-compliant protection of units, it is essential that you use "UL-listed" or "UL-recognized" fuses.

Fuses for the field circuit

Recommended fuses for the field circuit

Rated DC current for converter unit	Max. field current	2 Siemens fuses		2 Bussmann fuses FWP 700V 	
		Order No. per unit	A	Order No. per unit	A
A	A				
15	3	5SD420	16	FWP-5B	5
30	5	5SD420	16	FWP-5B	5
60 ... 125	10	5SD420	16	FWP-15B	15
210 ... 280	15	5SD440	25	FWP-20B	20
400 ... 600	25	5SD440	25	FWP-30B	30
710 ... 850	30	5SD480	30	FWP-35B	35
900 ... 3 000	40	3NE1802-0 ¹⁾	40	FWP-50B	50
1 500 ... 3 000 with option L85	85	3NE8021-1 ¹⁾	100	FWP-100B	100

Fuses for the armature circuit

Units, two-quadrant operation: 400 V, 575 V, 690 V, 830 V and 950 V

Phase fuses

Unit Type	3 phase fuses Siemens 			
	//V A/V	Order No. per unit	//V A/V	
6RA8025-6DS22	60/400	3NE1817-0	50/690	
6RA8025-6GS22	60/575	3NE1817-0	50/690	
6RA8028-6DS22	90/400	3NE1820-0	80/690	
6RA8031-6DS22	125/400	3NE1021-0	100/690	
6RA8031-6GS22	125/575	3NE1021-0	100/690	
6RA8075-6DS22	210/400	3NE3227	250/1 000	
6RA8075-6GS22	210/575	3NE3227	250/1 000	
6RA8078-6DS22	280/400	3NE3231	350/1 000	
6RA8081-6DS22	400/400	3NE3233	450/1 000	
6RA8081-6GS22	400/575	3NE3233	450/1 000	
6RA8085-6DS22	600/400	3NE3336	630/1 000	
6RA8085-6GS22	600/575	3NE3336	630/1 000	
6RA8087-6DS22	850/400	3NE3338-8	800/800	
6RA8087-6GS22	800/575	3NE3338-8	800/800	
6RA8086-6KS22	720/690	3NE3337-8	710/900	

¹⁾ UL-recognized

Selection and ordering data (continued)

Arm fuses



Note:

The arm fuses are included in the unit. No external semiconductor fuses are required.

Unit Type	Arm fuses Siemens 			
	//V A/V	Fuses	Order No. per unit	//V A/V
6RA8091-6DS22	1 200/400	6	3NE3338-8	800/800
6RA8090-6GS22	1 100/575	6	3NE3338-8	800/800
6RA8090-6KS22	1 000/690	6	3NE3337-8	710/900
6RA8088-6LS22	950/830	6	3NE3337-8	710/900
6RA8093-4DS22	1 600/400	6	6RY1702-0BA02	1 000/660
6RA8093-4GS22	1 600/575	6	6RY1702-0BA02	1 000/660
6RA8093-4KS22	1 500/690	6	6RY1702-0BA03	1 000/1 000
6RA8093-4LS22	1 500/830	6	6RY1702-0BA03	1 000/1 000
6RA8095-4DS22	2 000/400	6	6RY1702-0BA01	1 250/660
6RA8095-4GS22	2 000/575	6	6RY1702-0BA01	1 250/660
6RA8095-4KS22	2 000/690	12	6RY1702-0BA04	630/1 000
6RA8095-4LS22	1 900/830	12	6RY1702-0BA04	630/1 000
6RA8096-4GS22	2 200/575	6	6RY1702-0BA05	1 500/660
6RA8096-4MS22	2 200/950	12	6RY1702-0BA07	800/1 250
6RA8097-4KS22	2 600/690	12	6RY1702-0BA08	1 000/1 000
6RA8097-4GS22	2 800/575	12	6RY1702-0BA08	1 000/1 000
6RA8098-4DS22	3 000/400	12	6RY1702-0BA08	1 000/1 000

Units, two-quadrant operation: 480 V

Phase fuses

Unit Type	//V A/V	3 phase fuses Siemens 		3 phase fuses Bussmann 		3 phase fuses Bussmann  ¹⁾	
		Order No. per unit	//V A/V	Order No. per unit	//V A/V	Order No. per unit	//V A/V
6RA8025-6FS22	60/480	3NE1817-0	50/690	170M1565	63/660	FWH-60B	60/500
6RA8028-6FS22	90/480	3NE1820-0	80/690	170M1567	100/660	FWH-100B	100/500
6RA8031-6FS22	125/480	3NE1021-0	100/690	170M1568	125/660	FWH-125B	125/500
6RA8075-6FS22	210/480	3NE3227	250/1 000	170M3166	250/660	FWH-225A	225/500
6RA8078-6FS22	280/480	3NE3231	350/1 000	170M3167	315/660	FWH-275A	275/500
6RA8082-6FS22	450/480	3NE3233	450/1 000	170M3170	450/660	FWH-450A	450/500
6RA8085-6FS22	600/480	3NE3336	630/1 000	170M4167	700/660	FWH-600A	600/500
6RA8087-6FS22	850/480	3NE3338-8	800/800	170M5165	900/660	FWH-800A	800/500

Arm fuses

Note:

The arm fuses are included in the unit. No external semiconductor fuses are required.

Unit Type	Arm fuses Siemens 			
	//V A/V	Fuses	Order No. per unit	//V A/V
6RA8091-6FS22	1 200/480	6	3NE3338-8	800/800

¹⁾ FWH-... fuses are not mechanically compatible with 3NE or 170M fuses.

SINAMICS DCM



Accessories and supplementary components

Line fuses

Selection and ordering data (continued)

Units, four-quadrant operation: 400 V, 575 V, 690 V, 830 V and 950 V

Phase fuses, DC fuse

Unit Type	//V A/V	3 phase fuses Siemens 		1 DC fuse Siemens 	
		Order No. per unit	//V A/V	Order No. per unit	//V A/V
6RA8013-6DV62	15/400	3NE1814-0	20/690	3NE1814-0	20/690
6RA8018-6DV62	30/400	3NE8003-1	35/690	3NE4102	40/1 000
6RA8025-6DV62	60/400	3NE1817-0	50/690	3NE4120	80/1 000
6RA8025-6GV62	60/575	3NE1817-0	50/690	3NE4120	80/1 000
6RA8028-6DV62	90/400	3NE1820-0	80/690	3NE4122	125/1 000
6RA8031-6DV62	125/400	3NE1021-0	100/690	3NE4124	160/1 000
6RA8031-6GV62	125/575	3NE1021-0	100/690	3NE4124	160/1 000
6RA8075-6DV62	210/400	3NE3227	250/1 000	3NE3227	250/1 000
6RA8075-6GV62	210/575	3NE3227	250/1 000	3NE3227	250/1 000
6RA8078-6DV62	280/400	3NE3231	350/1 000	3NE3231	350/1 000
6RA8081-6DV62	400/400	3NE3233	450/1 000	3NE3233	450/1 000
6RA8081-6GV62	400/575	3NE3233	450/1 000	3NE3233	450/1 000
6RA8085-6DV62	600/400	3NE3336	630/1 000	3NE3336	630/1 000
6RA8085-6GV62	600/575	3NE3336	630/1 000	3NE3336	630/1 000
6RA8087-6DV62	850/400	3NE3338-8	800/800	3NE3334-0B ¹⁾	500/1 000
6RA8087-6GV62	850/575	3NE3338-8	800/800	3NE3334-0B ¹⁾	500/1 000
6RA8086-6KV62	760/690	3NE3337-8	710/900	3NE3334-0B ¹⁾	500/1 000

Arm fuses

Note:

The arm fuses are included in the unit. No external semiconductor fuses are required.

Unit Type	//V A/V	Arm fuses Siemens 		
		Fuses	Order No. per unit	//V A/V
6RA8091-6DV62	1 200/400	6	3NE3338-8	800/800
6RA8090-6GV62	1 100/575	6	3NE3338-8	800/800
6RA8090-6KV62	1 000/690	6	3NE3337-8	710/900
6RA8088-6LV62	950/830	6	3NE3337-8	710/900
6RA8093-4DV62	1 600/400	6	6RY1702-0BA02	1 000/660
6RA8093-4GV62	1 600/575	6	6RY1702-0BA02	1 000/660
6RA8093-4KV62	1 500/690	6	6RY1702-0BA03	1 000/1 000
6RA8093-4LV62	1 500/830	6	6RY1702-0BA03	1 000/1 000
6RA8095-4DV62	2 000/400	6	6RY1702-0BA01	1 250/660
6RA8095-4GV62	2 000/575	6	6RY1702-0BA01	1 250/660
6RA8095-4KV62	2 000/690	12	6RY1702-0BA04	630/1 000
6RA8095-4LV62	1 900/830	12	6RY1702-0BA04	630/1 000
6RA8096-4GV62	2 200/575	6	6RY1702-0BA05	1 500/660
6RA8096-4MV62	2 200/950	12	6RY1702-0BA07	800/1 250
6RA8097-4KV62	2 600/690	12	6RY1702-0BA08	1 000/1 000
6RA8097-4GV62	2 800/575	12	6RY1702-0BA08	1 000/1 000
6RA8098-4DV62	3 000/400	12	6RY1702-0BA08	1 000/1 000

¹⁾ Two fuses connected in parallel.

SINAMICS DCM



Accessories and supplementary components

Line fuses



Selection and ordering data (continued)

Units, four-quadrant operation: 480 V

Phase fuses

Unit		3 phase fuses Siemens 		3 phase fuses Bussmann 		3 phases fuses Bussmann  ²⁾	
Type	//V A/V	Order No. per unit	//V A/V	Order No. per unit	//V A/V	Order No. per unit	//V A/V
6RA8013-6FV62	15/480	3NE1814-0	20/690	170M1562	32/660	FWH-35B	35/500
6RA8018-6FV62	30/480	3NE1815-0	25/690	170M1562	32/660	FWH-35B	35/500
6RA8025-6FV62	60/480	3NE1817-0	50/690	170M1565	63/660	FWH-60B	60/500
6RA8028-6FV62	90/480	3NE1820-0	80/690	170M1567	100/660	FWH-100B	100/500
6RA8031-6FV62	125/480	3NE1021-0	100/690	170M1568	125/660	FWH-125B	125/500
6RA8075-6FV62	210/480	3NE3227	250/1 000	170M3166	250/660	FWH-225A	225/500
6RA8078-6FV62	280/480	3NE3231	350/1 000	170M3167	315/660	FWH-275A	275/500
6RA8082-6FV62	450/480	3NE3233	450/1 000	170M3170	450/660	FWH-450A	450/500
6RA8085-6FV62	600/480	3NE3336	630/1 000	170M4167	700/660	FWH-600A	600/500
6RA8087-6FV62	850/480	3NE3338-8	800/800	170M5165	900/660	FWH-800A	800/500

DC fuse

Unit		1 DC fuse Siemens 		1 DC fuse Bussmann  ²⁾	
Type	//V A/V	Order No. per unit	//V A/V	Order No. per unit	//V A/V
6RA8013-6FV62	15/480	3NE1814-0	20/690	FWP-35B	35/660
6RA8018-6FV62	30/480	3NE4102	40/1 000	FWP-35B	35/660
6RA8025-6FV62	60/480	3NE4120	80/1 000	FWP-70B	70/660
6RA8028-6FV62	90/480	3NE4122	125/1 000	FWP-125A	125/660
6RA8031-6FV62	125/480	3NE4124	160/1 000	FWP-150A	150/660
6RA8075-6FV62	210/480	3NE3227	250/1 000	FWP-250A	250/660
6RA8078-6FV62	280/480	3NE3231	350/1 000	FWP-350A	350/660
6RA8082-6FV62	450/480	3NE3334-0B	500/1 000	FWP-500A	500/660
6RA8085-6FV62	600/480	3NE3336	630/1 000	FWP-700A	700/660
6RA8087-6FV62	850/480	3NE3334-0B ¹⁾	500/1 000	FWP-1000A	1 000/660

Arm fuses

Note:

The arm fuses are included in the unit. No external semiconductor fuses are required.

Unit		Arm fuses Siemens 		
Type	//V A/V	Fuses	Order No. per unit	//V A/V
6RA8091-6FV62	1 200/480	6	3NE3338-8	800/800

¹⁾ Two fuses connected in parallel.

²⁾ FWH-... and FWP-... fuses are not mechanically compatible with 3NE or 170M fuses.

SINAMICS DCM

Accessories and supplementary components

Commutating reactors

Overview

Commutating reactors

A converter must always be connected to the line supply through a commutation inductance. This must have at least 4 % u_K ! The commutation inductance can be in the form of a converter transformer or, for the appropriate line supply, in the form of a commutating reactor.

A line supply can be considered to be "stiff" if the power ratio P_s/S_k is ≤ 0.01 . Even for stiff line supplies, the commutation inductance must have a u_K of at least 4 %!

For high-rating converters, the line reactance, i.e. the finite fault level (short-circuit power) of the line supply must be taken into account; this also results in higher u_K values. Recommendation

for the ratio of the line supply fault level (short-circuit power) to the apparent drive power $> 33:1$.

The commutating reactors are dimensioned according to the rated motor current in the armature or field circuit.

Operation with line frequencies of 50 Hz and 60 Hz

The rated currents I_{Ln} of the reactors, specified in the table, apply for operation with a line frequency $f = 50$ Hz. It is permissible to operate the reactors with a line frequency $f = 60$ Hz. In this case, a 10 % larger reactor should be used.

At the same time, the voltage drop ΔV increases by 8 %.

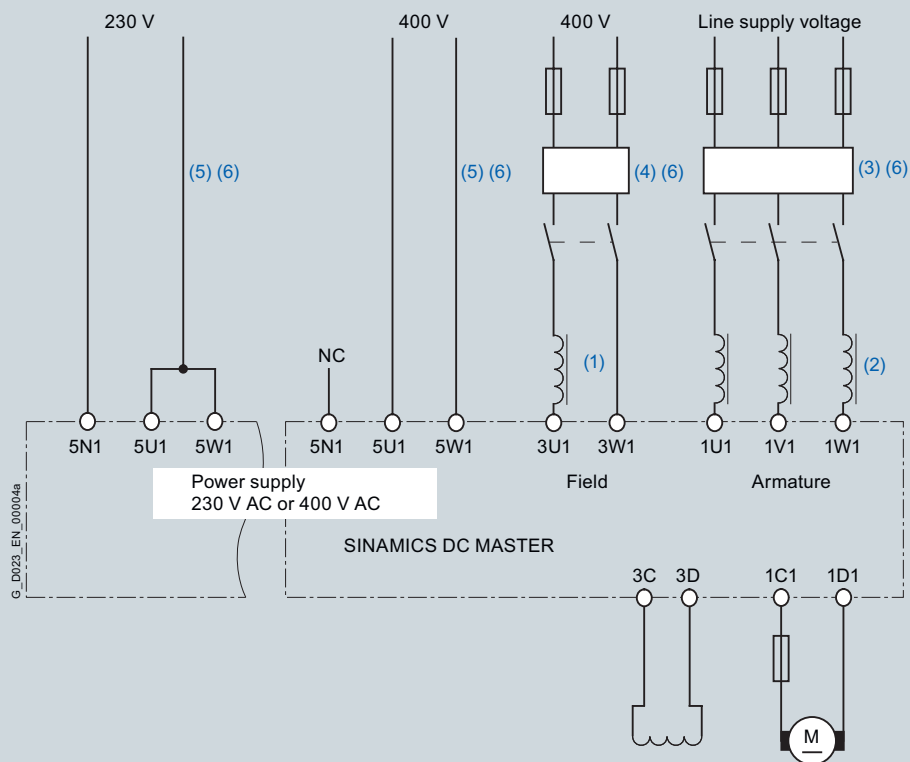

Arrangement of reactors and radio interference suppression filters

- (1) The commutating reactor in the field circuit is dimensioned for the rated motor field current.
- (2) The commutating reactor in the armature circuit is dimensioned for the rated motor armature current.
The line current is 0.82 times the DC current.
- (3) The radio interference suppression filter for the armature circuit is dimensioned for the rated motor armature current.
The line current is 0.82 times the DC current.
- (4) The radio interference suppression filter for the field circuit is dimensioned for the rated motor field current.
- (5) Radio interference suppression filters are not required for the electronics power supply alone. Current consumption at 400 V 1 A, at 230 V 2 A.
- (6) If the power supply voltages for the armature circuit, field circuit and electronics power supply are the same, then the voltage for the field and electronics power supply can also be taken after the radio interference suppression filter for the armature circuit.

SINAMICS DCM

Accessories and supplementary components

Commutating reactors

Selection and ordering data



Note:

The commutating reactors are dimensioned according to the rated motor current in the armature and field circuits. For single-phase operation, single-phase commutating reactors should be used in the armature circuit. The following table provides an overview and can be a guide for selection. Please find detailed information in Catalog LV 60.

Thermal continuous current ²⁾	Maximum AC current	Continuous permissible DC current ³⁾	Commutating reactor			
			4 % per unit voltage drop u_D of the reactor at $I_{th\ max}$ and V_N			
$I_{th\ max}$	$I_{L\ max}$	I_{dn}	400 V	500 V	690 V	750 V
A	A	A	Order No.	Order No.	Order No.	Order No.
Single-phase commutating reactor $I_{th\ max} = I_{L\ max}$ with inductive load						
8	8	9.8	4EM4807-1CB00	–	–	–
10	10	12.3	4EM4911-7CB00	–	–	–
11.2	11.2	13.7	4EM4911-8CB00	–	–	–
12.5	12.5	15.3	4EM4912-0CB00	–	–	–
14	14	17.2	4EM4912-1CB00	–	–	–
15	15	18.4	4EM5000-2CB00	–	–	–
18	18	22	4EM5005-6CB00	–	–	–
20	20	24.5	4EM5005-7CB00	–	–	–
22.4	22.4	27.4	4EM5005-8CB00	–	–	–
24	24	29.4	4EM5100-2CB00	–	–	–
28	28	34	4EM6100-2CB00	–	–	–
31.5	31.5	39	4EM6100-3CB00	–	–	–
35.5	35.5	43	4EM5212-8CB00	–	–	–
40	40	49	4EM5200-1CB00	–	–	–
45	45	55	4EM6200-3CB00	–	–	–
50	50	61	4EM5316-6CB00	–	–	–
Three-phase commutating reactor $I_{th\ max} = 0.8 \times I_{L\ max}$ with inductive load, 50 Hz 3 AC						
16	20	19.6	4EP3601-3DS00	4EP3601-8DS00	–	–
18	22.4	22	4EP3601-4DS00	4EP3602-0DS00	–	–
20	25	24.5	4EP3601-5DS00	4EP3702-0DS00	–	–
22.4	28	27.4	–	4EP3702-1DS00	–	–
25	31.5	31	4EP3701-5DS00	4EP3702-2DS00	–	–
28	35.5	34	4EP3701-6DS00	4EP3801-7DS00	–	–
31.5	40	39	4EP3701-7DS00	4EP3801-8DS00	–	–
35.5	45	43	4EP3701-8DS00	4EP3802-0DS00	–	–
40	50	49	4EP3800-2DS00	4EP3800-4DS00	–	–
45	56	55	4EP3801-6DS00	4EP3901-5DS00	–	–
50	63	61	4EP3800-3DS00	4EP3900-3DS00	–	–
56	71	69	4EP3901-4DS00	4EP4003-1DS00	–	–
63	80	77	4EP3900-2DS00	4EP4000-4DS00	–	–
71	91	87	4EP4002-7DS00	4EP4003-2DS00	–	–
80	100	98	4EP4000-3DS00	4EU2422-8AA00-0AA0	–	–
91	112	112	4EP4002-8DS00	4EU2422-0BA00-0AA0	–	–

Note:

Commutating reactors for 830 and 950 V on request.

¹⁾ All reactors with $V_N \leq 600$ V acc. to UL

²⁾ Rated current $I_{Ln} = 0.9 \times I_{th\ max}$

³⁾ For a downstream six-pulse bridge circuit

SINAMICS DCM

Accessories and supplementary components

Commutating reactors

Selection and ordering data (continued)



Thermal continuous current ²⁾	Maximum AC current	Continuous permissible DC current ³⁾	Commutating reactor			
$I_{th\ max}$	$I_{L\ max}$	I_{dn}	4 % per unit voltage drop u_D of the reactor at $I_{th\ max}$ and V_N			
A	A	A	400 V	500 V	690 V	750 V
			Order No.	Order No.	Order No.	Order No.
Three-phase commutating reactor $I_{th\ max} = 0.8 \times I_{L\ max}$ with inductive load, 50 Hz 3 AC (continued)						
100	125	123	4EP4003-0DS00	4EU2522-6BA00-0AA0	–	–
112	140	137	4EU2422-6AA00-0AA0	4EU2522-7BA00-0AA0	–	–
125	160	153	4EU2422-7AA00-0AA0	4EU2522-8BA00-0AA0	–	–
140	180	172	4EU2522-2BA00-0AA0	4EU2522-0CA00-0AA0	–	–
160	200	196	4EU2522-3BA00-0AA0	4EU2722-0CA00-0AA0	–	–
180	224	221	4EU2522-4BA00-0AA0	4EU2722-1CA00-0AA0	–	–
200	250	245	4EU2522-5BA00-0AA0	4EU2722-2CA00-0AA0	4EU2722-0DA00-1BA0	–
224	280	275	4EU2722-5BA00-0AA0	4EU2722-3CA00-0AA0	4EU3022-8BA00-0AA0	–
250	315	306	4EU2722-6BA00-0AA0	4EU2722-4CA00-0AA0	4EU3022-0CA00-0AA0	4EU3022-2CA00-0AA0
280	355	343	4EU2722-7BA00-0AA0	4EU3022-5BA00-0AA0	4EU3022-1CA00-0AA0	4EU3622-5DA00-0AA0
315	400	386	4EU2722-8BA00-0AA0	4EU3022-6BA00-0AA0	4EU3622-0DA00-0AA0	4EU3622-6DA00-0AA0
355	450	435	4EU3022-1BA00-0AA0	4EU3022-7BA00-0AA0	4EU3622-1DA00-0AA0	4EU3622-7DA00-0AA0
400	500	490	4EU3022-2BA00-0AA0	4EU3622-4CA00-0AA0	4EU3622-2DA00-0AA0	4EU3622-8DA00-1BA0
450	560	551	4EU3022-3BA00-0AA0	4EU3622-5CA00-0AA0	4EU3622-3DA00-0AA0	4EU3622-0EA00-1BA0
500	630	613	4EU3022-4BA00-0AA0	4EU3622-6CA00-0AA0	4EU3622-4DA00-0AA0	4EU3921-1CA00-0A
560	710	686	4EU3622-0CA00-0AA0	4EU3622-7CA00-0AA0	4EU3921-8BA00-0A	4EU3921-2CA00-0A
630	800	772	4EU3622-1CA00-0AA0	4EU3622-8CA00-1BA0	4EU3921-0CA00-0A	4EU4321-4DA00-0A
710	910	870	4EU3622-2CA00-1BA0	4EU3921-6BA00-0A	4EU4321-0DA00-0A	4EU4321-5DA00-0A
800	1 000	980	4EU3622-3CA00-1BA0	4EU3921-7BA00-0A	4EU4321-1DA00-0A	4EU4321-6DA00-0A
910	1 120	1 115	4EU3921-2BA00-0A	4EU4321-4CA00-0A	4EU4321-2DA00-0A	4EU4521-4BA00
980	1 230	1 200	–	–	4EU4321-0AY00-0A	–
1 000	1 250	1 225	4EU3921-3BA00-0A	4EU4321-5CA00-0A	4EU4321-3DA00-0A	4EU4521-5BA00
1 040	1 300	1 280	4EU3921-0AL00-0A	4EU4321-0AX00-0A⁴⁾	–	–
1 310	1 640	1 600	4EU4321-0AW00-0A	4EU4521-0AK00⁴⁾	4EU4521-0AP00	–
1 600	2 000	1 951	4EU4321-0CH10-0A	4EU4521-0CP10-0C	4EU5121-0BD10-0C	4EU5021-0AM10-0C
1 800	2 250	2 195	4EU4321-0CK10-0C	4EU4521-0CQ10-0C	4EU5121-0BE10-0C	4EU5221-0BF10-0C
2 000	2 500	2 439	4EU9921-0BG10-0B	4EU5121-0BA10-0C	4EU5121-0BF10-0C	4EU5221-0BG10-0C
2 250	2 812.5	2 744	4EU5021-0AL10-0C	4EU5121-0BB10-0C	4EU5121-0BG10-0C	4EU5221-0BH10-0C
2 500	3 125	3 049	4EU5021-0AK10-0B	4EU5121-0BC10-0C	4EU5421-0AV10-0C	4EU5621-0AW10-0C

Note:
Commutating reactors for 830 and 950 V on request.

1) All reactors with $V_N \leq 600$ V acc. to UL

2) Rated current $I_{Ln} = 0.9 \times I_{th\ max}$

3) For a downstream six-pulse bridge circuit

4) Per unit voltage drop of the reactor $u_D \cong 4$ % at I_{Ln} and $V_N = 575$ V

Overview

The main contactor or the circuit-breaker in front of the three-phase armature supply of the converter is used to switch-on the power section in a correct manner when the electronics and the voltage for the thyristor modules is enabled if the unit is still not operational. This is the reason that the contactor or the circuit-breaker must always be energized via terminals XR1-109-110. When a circuit-breaker is used, a motor-operated mechanism must be used to close the circuit-breaker and an undervoltage release to open the circuit-breaker.

Selection criteria

The internal control sequence guarantees that the switching operations are always made in a no-current condition. When selecting the main contactor, the utilization category AC-1 or for a circuit-breaker, the maximum rated current $I_{n\max}$ should be used as basis. If the current and voltage quantities permit it, then generally, the more cost-effective solution using a contactor is preferred over a circuit-breaker.

Radio interference suppression filters

Overview

SINAMICS DC MASTER applications are in compliance with the EMC product standard EN 61800-3 for electric drives when taking into account that the units are integrated into the plant or system in compliance with EMC rules.

However, EMC legislation does stipulate that the plant or system as a whole must be electromagnetically compatible with its environment.

If radio interference suppression level "A1" according to EN 55011 is to be achieved, then in addition to the commutating reactors, a radio interference suppression filter is also required. Radio interference suppression filters reduce radio interference voltages of the converter that occur in conjunction with the commutating reactor. It is only possible to use radio interference suppression filters for grounded line supplies.

Radio interference suppression filters generate leakage currents. In accordance with DIN VDE 0160, a PE connection with a cross-section of 10 mm² is required. For the filters to have optimum effect, it is absolutely essential that they and the unit are installed on a single metal plate.

For converter units with 3-phase connection, the minimum rated filter current is equal to the DC output current of the unit times 0.82. For a two-phase connection (field power section or single-phase operation of the armature power section) only two phases are connected to the three-phase radio interference suppression filter. In this case, the line current is equal to the DC field current.

List of the recommended radio interference suppression filters from EPCOS

Rated current Radio interference suppression filter	Radio interference suppression filter	Terminal cross-section (mm ²) or threaded hole	Weight, approx. kg	Dimensions (W × H × D) mm × mm × mm
A	Type		kg	mm × mm × mm
8	B84143-G8 -R 1 1	4 mm ²	1.3	80 × 230 × 50
20	B84143-G20 -R 1 1	4 mm ²	1.3	80 × 230 × 50
36	B84143-G36 -R 1 1	6 mm ²	2.8	150 × 280 × 60
50	B84143-G50 -R 1 1	16 mm ²	3.3	150 × 60 × 330
66	B84143-G66 -R 1 1	25 mm ²	4.4	150 × 330 × 80
90	B84143-G90 -R 1 1	25 mm ²	4.9	150 × 330 × 80
120	B84143-G120 -R 1 1	50 mm ²	7.5	200 × 380 × 90
150	B84143-G150 -R 1 1	50 mm ²	8.0	200 × 380 × 90
220	B84143-G220 -R 1 1	95 mm ²	11.5	220 × 430 × 110
150	B84143-B150 -S	M10	13	140 × 310 × 170
180	B84143-B180 -S	M10	13	140 × 310 × 170
250	B84143-B250 -S	M10	15	115 × 360 × 190
320	B84143-B320 -S	M10	21	115 × 360 × 260
400	B84143-B400 -S	M10	21	115 × 360 × 260
600	B84143-B600 -S	M10	22	115 × 410 × 260
1 000	B84143-B1000-S	M12	28	165 × 420 × 300
1 600	B84143-B1600-S	2 × M12	34	165 × 420 × 300
2 500	B84143-B2500-S	4 × M12	105	200 × 810 × 385
500 V	2 0			
760 V	2 1			
690 V	2 4			
480 V	0			
530 V	2			

SINAMICS DCM

Accessories and supplementary components

Radio interference suppression filters

Overview (continued)

List of the recommended radio interference suppression filters from Siemens

Rated current Radio interference suppression filter	Radio interference suppression filter	Terminal cross-section	Ground stud	Weight, approx.	Dimensions (W × H × D)
A	Type	mm ²		kg	mm × mm × mm
12	6SE7021-0ES87-0FB1	4	M6	2.5	215 × 90 × 81
18	6SE7021-8ES87-0FB1	4	M6	2.5	215 × 90 × 81
36	6SE7023-4ES87-0FB1	16	M6	4	231 × 101 × 86
80	6SE7027-2ES87-0FB1	50	M10	9	308 × 141 × 141
120	6SE7031-2ES87-0FA1	50	M10	10	348 × 171 × 141
190	6SE7031-8ES87-0FA1	95	M10	10	404 × 171 × 141
320	6SE7033-2ES87-0FA1	Connecting lug	M10 × 30	21	300 × 260 × 116
600	6SE7036-0ES87-0FA1	Connecting lug	M10 × 30	22	350 × 260 × 116
1 000	6SE7041-0ES87-0FA1	Connecting lug	M10 × 30	28	350 × 300 × 166
1 600	6SE7041-6ES87-0FB1	Connecting lug	M12 × 30	34	400 × 300 × 166

Technical specifications

Radio interference suppression filter

Rated supply voltage	380 ... 460 V (± 15 %) 3 AC
Rated frequency	50/60 Hz (± 6 %)
Ambient temperature during operation	0 ... +40 °C
Degree of protection in accordance with EN 60529	IP20 IP00 from 500 A

Application

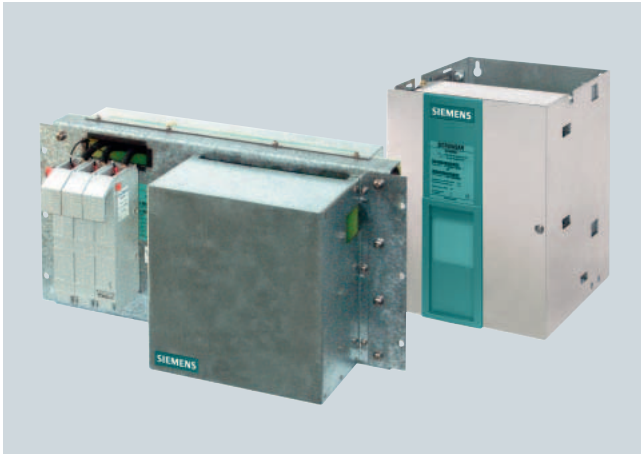

SICROWBAR AC overvoltage protection is used to protect power semiconductors (thyristors and diodes) in converters against overvoltages between the phases of a three-phase line supply. The range of applications is not restricted to protecting DC drive converters, but can also be used for infeed/regenerative feedback units of AC drive systems that are equipped with thyristors. Overvoltages that occur on the AC side of converters are mainly caused by switching operations when disconnecting from the line supply at the transformer primary. This applies both to operational switching operations (shutdown under no-load conditions) as well as in the case of a fault (shutdown under load).

Overvoltage protection is normally used in the following configuration:

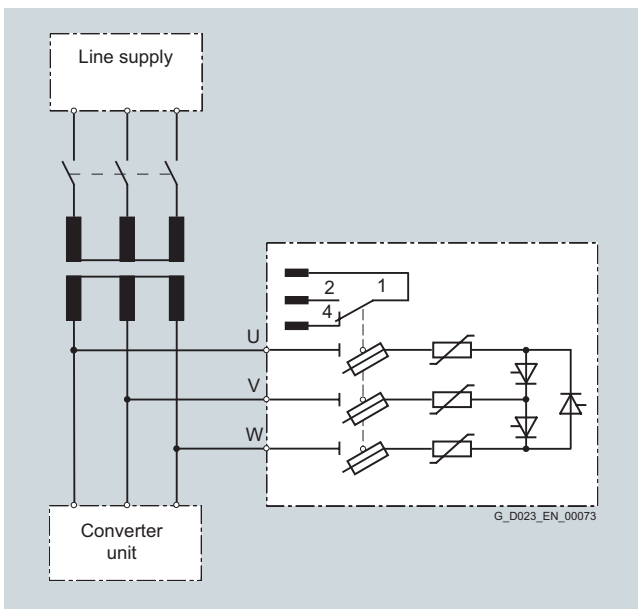

Design

There are three device versions depending on the rated voltage:

Version	Rated voltage	Design, installation
A	Up to 580 V	Mounted in an enclosure. For mounting in an upright position on panels in cabinets or machine frames.
B	Up to 725 V	Mounted on a baseplate. For installation in 600 mm wide cabinets.
C	Up to 1 150 V	Mounted on a baseplate. For installation in 600 mm wide cabinets.

The power section of the overvoltage protection device has a P3C connection, 3-pulse fully controlled polygon connection. The feeders to the polygon connection have metaloxide varistors that absorb overvoltage energy.

Semiconductor fuses included in the devices are accommodated in a fused disconnecter with integrated fuse monitoring.

The break-over diodes (BOD) and RC snubbers for the thyristors and varistors are mounted on a printed circuit board as are also the gate series resistors and diodes that transfer the line voltage to the break-over diodes.

Mode of operation

If an overvoltage occurs, which reaches the response voltage of the integrated firing module, then the break-over diodes trigger and in turn trigger their associated thyristors. As a consequence, the varistors are switched to the line supply. The varistors absorb the overvoltage energy. An RC snubber circuit protects the thyristors against an excessively steep voltage gradient when the current is interrupted.

Configuration

Notes on selection

The following conditions should be maintained when selecting the overvoltage protection:

- The limit voltage of the overvoltage protection V_{RRM55} must not exceed the highest periodic and permissible peak blocking voltage of the power semiconductor to be protected.
- The rated supply voltage of the overvoltage protection must not be exceeded.
- Commutation overvoltages of the converter that periodically occur must remain below the response voltage of the overvoltage protection. The energy absorption capability of the selected overvoltage protection should be checked. A distinction must be made between two operating cases:
 - A transformer is shut down under no-load conditions
 - A transformer is shut down under load

Detailed notes on configuration, standards and connection of the overvoltage protection are provided in the Operating Instructions, on the DVD-ROM supplied with this catalog or in the Internet under

<http://support.automation.siemens.com/WW/view/en/18260008/130000>.

SINAMICS DCM

Accessories and supplementary components

SICROWBAR AC overvoltage protection

Technical specifications

General technical data	SICROWBAR AC overvoltage protection
Degree of protection	IP00 acc. to EN 60529
Protection class	I according to EN 50178
Overvoltage category	III, corresponding to EN 60664
Dimensioning creepages and clearances	Pollution degree 2 acc. to EN 50178
Rated insulation voltage (for installation altitudes up to 2 000 m above sea level) ¹⁾	725 V AC for rated supply voltages of 400 ... 725 V 1 200 V AC for rated supply voltages of 850 ... 1 150 V
Installation altitude	≤ 2 000 m above sea level
Permissible ambient temperature	
• In operation	+5 ... +55 °C
• In storage	-40 ... +70 °C
Climate class	3K3 acc. to EN 60721-3-3
Fuse monitoring (microswitch at the fused disconnecter, 1 changeover contact)	Flat connector 6.3 mm × 0.8 mm
• Disconnecter closed, all fuse links OK	1/2 closed, 1/4 opened
• Disconnecter closed, one or several fuse links defective	1/4 closed, 1/2 opened
• Disconnecter open	1/4 closed, 1/2 opened
• Maximum switching capacity	50 Hz 250 V AC, 3 A 30 V DC, 3 A

4

	SICROWBAR AC overvoltage protection				
		7VV3002-3CD20	7VV3002-3AD20	7VV3002-3BD20	7VV3002-3GD20
Max. permissible rated supply voltage V_N	V	460		550	
Nominal response voltage of the BOD element V_{AN}	V	1 000	1 200	1 400	1 600
Min. limit voltage of BOD element at 5 °C $V_{RRM_{05}}$	V	864	1 056	1 248	1 440
Max. limit voltage of BOD element at 55 °C $V_{RRM_{55}}$	V	1 166	1 378	1 590	1 802
Max. permissible peak current, I_{max}	A	200	1 000		2 000
Rated insulation voltage (the insulation voltage is determined by the highest rated supply voltage of the relevant construction type) V_{ISO}	V	550			
Varistor voltage (breakdown voltage) at $T_A = 25$ °C, 1 mA (data sheet value × 2 for 2 series-connected varistors) V_V	V	720		860	
Max. energy (for 2 ms) at $T_A = 85$ °C (data sheet value × 2 for 2 series-connected varistors) W_0	Ws	600		720	
Energy that can be absorbed 100 times (determined from the derating data) W_2	Ws	350		419	
Energy that can be absorbed 10 000 times (determined from the derating data) W_4	Ws	42		50	
Version		A			
Dimensions					
• Width	mm	265			
• Height	mm	385			
• Depth	mm	237			
Weight, approx.	kg	7			

¹⁾ Installation altitudes above 2 000 m on request.

SINAMICS DCM

Accessories and supplementary components

SICROWBAR AC overvoltage protection

Technical specifications (continued)

		SICROWBAR AC overvoltage protection				
		7VV3002-3DD20	7VV3002-3ED20	7VV3002-3JD20	7VV3002-3KD20	7VV3002-3LD20
Max. permissible rated supply voltage V_N	V	770	920		1 100	
Nominal response voltage of the BOD element V_{AN}	V	1 900	2 400	2 600	2 800	3 000
Min. limit voltage of BOD element at 5 °C $V_{RRM,05}$	V	1 728	2 208	2 400	2 592	2 784
Max. limit voltage of BOD element at 55 °C $V_{RRM,55}$	V	2 120	2 650	2 862	3 074	3 286
Max. permissible peak current, I_{max}	A	300	800	1 000	400	1 000
Rated insulation voltage (the insulation voltage is determined by the highest rated supply voltage of the relevant construction type) V_{ISO}	V	770	1 100			
Varistor voltage (breakdown voltage) at $T_A = 25$ °C, 1 mA (data sheet value × 2 for 2 series-connected varistors) V_V	V	1 240	1 500		1 820	
Max. energy (for 2 ms) at $T_A = 85$ °C (data sheet value × 2 for 2 series-connected varistors) W_0	Ws	2 400	3 300		3 000	
Energy that can be absorbed 100 times (determined from the derating data) W_2	Ws	986	1 196		1 027	
Energy that can be absorbed 10 000 times (determined from the derating data) W_4	Ws	145	176		214	
Version		B	C			
Dimensions						
• Width	mm	580				
• Height	mm	305				
• Depth	mm	205	245			
Weight, approx.	kg	11	12			

Selection and ordering data

Rated supply voltage	Limit voltage	SICROWBAR AC overvoltage protection
V	V	Order No.
460	1 166	7VV3002-3CD20
460	1 378	7VV3002-3AD20
550	1 590	7VV3002-3BD20
550	1 802	7VV3002-3GD20
770	2 120	7VV3002-3DD20
920	2 650	7VV3002-3ED20
920	2 862	7VV3002-3JD20
1 100	3 074	7VV3002-3KD20
1 100	3 286	7VV3002-3LD20

Accessories

Spare parts, see in the Internet under <http://workplace.automation.siemens.de/sparesonweb>.

SINAMICS DCM

Accessories and supplementary components

SICROWBAR DC overvoltage protection

Application



SICROWBAR DC overvoltage protection protects windings and converters against overvoltage when supplying large inductances, e.g. field windings of synchronous machines, DC machines or hoisting solenoids.

Further, it is optionally possible to initiate fast de-excitation – triggered by a higher-level signal. An appropriate de-excitation/discharge resistor must be provided.

Design

The most important components of the device are:

- Two disk-type thyristors in an anti-parallel connection
- A firing circuit, which, depending on the version, triggers a thyristor in the blocking direction at a defined voltage
- A module to detect the voltage at the de-excitation/discharge resistor, detect the current being conducted, identify when the overvoltage protection device triggers and signal the status using binary outputs.
- The power connections C, D (copper bars)
- Terminal XEW1 to connect the sensor cable from the de-excitation/discharge resistor.
- An “Optional fast de-excitation” module (Option G11). The module allows the thyristors to be fired at any time by controlling three fast relays that are independent of one another.

Mode of operation

The two thyristors connected in an anti-parallel connection, located between connections C and D, can briefly (approx. 5 s) conduct the pulse current. The overvoltage triggers a break-over diode (BOD) on the trigger circuit which in turn triggers the blocking thyristor and conducts the firing current past the blocking thyristor through a diode connected in an anti-parallel configuration to its gate/cathode. Independent of the polarity of the overvoltage, the break-over diode is always operated in the same direction using a bridge rectifier and the firing current is limited to between 6 and 8 A using series resistors. The thyristor fires within just a microseconds and the voltage decreases quickly down to the forward voltage (1 to 1.5 V). The load current increases the temperature of the disk-type thyristor within just a few seconds and the thyristor and the stack construction absorb the thermal energy. As a consequence, the load cycle can only be repeated after a cooling time has elapsed (see Technical specifications).

The fast de-excitation option (G11) is connected to the firing circuit in such a way that the thyristors can be triggered at any time by controlling at least one of the three fast relays – that are independent of one another. This assumes that there is sufficient voltage. Generally, this is approximately 5 % of the trigger voltage. Each of the three relays can be controlled with 24 V DC, 110 V to 125 V DC or 220 V to 240 V DC.

The voltage detection for the de-excitation/discharge resistor is connected to the external de-excitation/discharge resistor. When the voltage detection responds, the supplying converter must be blocked or the current controlled down to zero. The voltage detection module requires an external 24 V DC power supply with min. 100 mA.

The de-excitation/discharge resistor is an external device and is not included in the scope of delivery of the SICROWBAR DC overvoltage protection. Its resistance must be so low that even at the highest load current, the voltage is still under the destruction limit of the supplying converter and/or the winding to be protected. The lowest possible resistance is defined by the supply voltage and the maximum load current of the converter (dimensioning the fuses). The required de-excitation time must also be taken into account when dimensioning the value of the resistance.

4

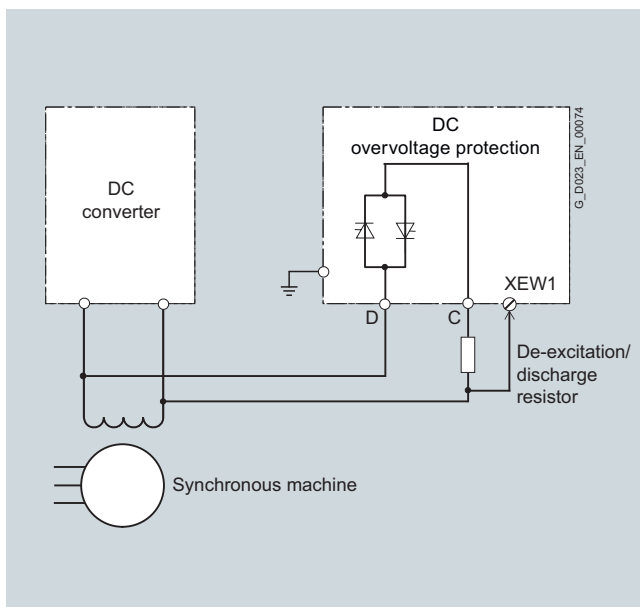

Configuration

The complete arrangement comprises a SICROWBAR DC overvoltage protection and de-excitation/discharge resistor.

The following device parameters that are used to select the device must be determined:

1. The firing voltage – if this is reached, then the thyristors of the SICROWBAR DC are turned-on.
2. The maximum current that flows or the maximum Pt value that occurs.

Detailed notes on the configuration, the standards that apply and the connection of the overvoltage protection are provided in the Operating Instructions, on the DVD-ROM supplied with this catalog or in the Internet under

<http://support.automation.siemens.com/WW/view/en/21690222/130000>

Typical load current characteristic for the three device power stages

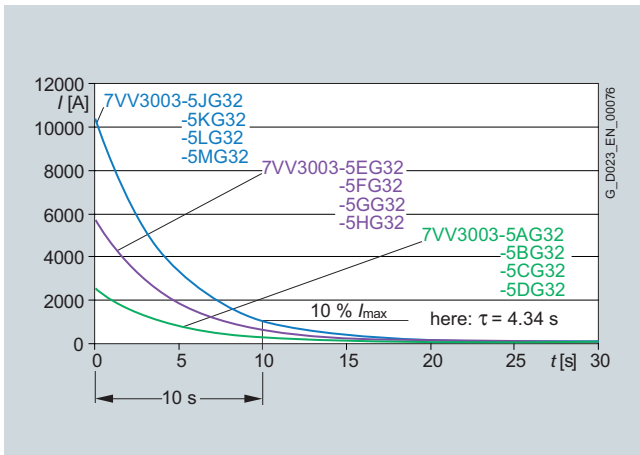

Cooling-down time

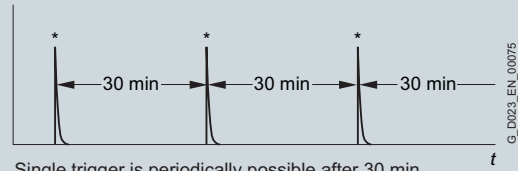

Single trigger is periodically possible after 30 min cooling-down time.

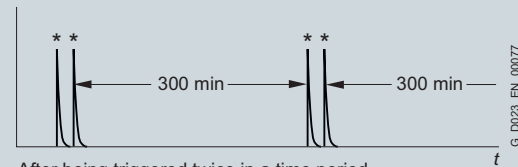

After being triggered twice in a time period < 30 min, a cooling-down time of 300 min is required.

SINAMICS DCM

Accessories and supplementary components

SICROWBAR DC overvoltage protection

Technical specifications

General technical data	SICROWBAR DC overvoltage protection
Degree of protection	IP00 acc. to EN 60529
Protection class	I acc. to EN 50178
Overvoltage category	III acc. to EN 60664
Dimensioning creepages and clearances	Pollution degree 2 acc. to EN 50178
Installation altitude	≤ 2 000 m above sea level
Insulation test voltage of the power section (first test) with respect to the housing, voltage detection (signal part) and fast de-excitation (control)	5.5 kV 50 Hz 1 minute corresponding to EN 60034-1 for rated exciting voltages up to 750 V DC
Climate class	3K3 acc. to EN 60721-3-3
Permissible ambient temperature	
• In operation	0 ... +40 °C
• In storage	-25 ... +70 °C
Power supply required for the voltage detection	24 V DC, +10 % , -20 % , 100 mA

		SICROWBAR DC overvoltage protection			
		7VV3003-5AG32	7VV3003-5BG32	7VV3003-5CG32	7VV3003-5DG32
Trigger voltage	V	800 ± 100	1 200 ± 100	1 600 ± 100	2 200 ± 150
Max. pulse current	kA	2.5			
Critical voltage gradient	V/μs	1 000			
Critical current gradient	A/μs	80			
$\bar{I}^2 t$	A ² s	13.6 × 10 ⁶			
Dimensions					
• Width	mm	265			
• Height	mm	350			
• Depth	mm	285			
Weight, approx.	kg	17			

		SICROWBAR DC overvoltage protection			
		7VV3003-5EG32	7VV3003-5FG32	7VV3003-5GG32	7VV3003-5HG32
Trigger voltage	V	1 600 ± 100	2 200 ± 150	2 600 ± 150	3 000 ± 150
Max. pulse current	kA	5.8			
Critical voltage gradient	V/μs	1 000			
Critical current gradient	A/μs	300			
$\bar{I}^2 t$	A ² s	73 × 10 ⁶			
Dimensions					
• Width	mm	265			
• Height	mm	350			
• Depth	mm	285			
Weight, approx.	kg	18			

		SICROWBAR DC overvoltage protection			
		7VV3003-5JG32	7VV3003-5KG32	7VV3003-5LG32	7VV3003-5MG32
Trigger voltage	V	1 600 ± 100	2 200 ± 150	2 600 ± 150	3 000 ± 150
Max. pulse current	kA	10.5			
Critical voltage gradient	V/μs	1 000			
Critical current gradient	A/μs	300			
$\bar{I}^2 t$	A ² s	239 × 10 ⁶			
Dimensions					
• Width	mm	265			
• Height	mm	350			
• Depth	mm	285			
Weight, approx.	kg	20			

SINAMICS DCM

Accessories and supplementary components

SICROWBAR DC overvoltage protection

Selection and ordering data

Pulse current, max. kA	Trigger voltage, typ. V	SICROWBAR DC overvoltage protection Order No.
2.5	800	7VV3003-5AG32
2.5	1 200	7VV3003-5BG32
2.5	1 600	7VV3003-5CG32
2.5	2 200	7VV3003-5DG32
5.8	1 600	7VV3003-5EG32
5.8	2 200	7VV3003-5FG32
5.8	2 600	7VV3003-5GG32
5.8	3 000	7VV3003-5HG32
10.5	1 600	7VV3003-5JG32
10.5	2 200	7VV3003-5KG32
10.5	2 600	7VV3003-5LG32
10.5	3 000	7VV3003-5MG32

Accessories

Spare parts, see in the Internet under <http://workplace.automation.siemens.de/sparesonweb>.

Options

Option	Order code	Notes	Order No. for separate order
Fast de-excitation	G11	Initiation of fast de-excitation using one of the three relays, of which each has the following control voltages: <ul style="list-style-type: none"> • 220 ... 240 V DC, +10 % -20 % • 110 ... 125 V DC, +10 % -20 % • 24 V DC, +10 % -20 % 	7VV3003-7FG00

SINAMICS DCM

Accessories and supplementary components

SIMOREG CCP

Overview



SIMOREG CCP

The Converter Commutation Protector SIMOREG CCP is used to protect line-commutated SINAMICS DC MASTER converters in inverter operation against inverter commutation faults.

For line-commutated inverters, an appropriate line-side counter voltage is required in order to commutate the current between the individual power semiconductors. Commutation can be prevented from being completed (commutation fault) as a result of uncontrolled switching operations, line supply dips (weak line supplies, thunderstorms, etc.). As a result, in the regenerative feedback direction, a high current flows through the line supply or a cross-current in the converter. This can result in fuses blowing or under certain circumstances can destroy the semiconductors.

The software of the SINAMICS DC MASTER identifies if inverter commutation faults are pending and then issues the command to turn off the power semiconductors in the converter to the SIMOREG CCP. SIMOREG CCP then turns off the power semiconductors, ensures that the conditions to reduce the current in the motor are present and absorbs the magnetic energy stored in the motor as electric energy.

Benefits

SIMOREG CCP limits the current that flows when inverter commutation faults occur to a non-hazardous value so that the thyristors and the associated super-fast fuses are protected. This eliminates the complex and time consuming replacement of fuses after inverter commutation faults.

Although inverter commutation faults cannot be prevented, their effects can be.

- Gear units and the driven machine are protected by shutting off the current in time before it reaches its possible maximum value in the case of a fault therefore protecting them against inadmissibly high torque surges.
- For high rated system currents, up until now, high-speed DC circuit-breakers were used to protect the fuses against rupture. By using the CCP, protection is now cost-effectively possible even for lower line currents, whereby SIMOREG CCP has the following advantages when compared to high-speed DC circuit-breakers even at high current levels:
 - Protection also for circulating currents
 - Lower system costs
 - Lower space requirements
 - No additional air reactor to reduce the current rate-of-rise when a fault occurs
 - Lower operating costs, as it requires no maintenance
 - High degree of availability

Design

SIMOREG CCP distinguishes itself as a result of the compact and space-saving design.

Function

The line supply voltage, line current as well as the armature voltage are continually sensed in the SINAMICS DC MASTER.

A possible commutation fault (inverter commutation fault – inverter shoot-through) is detected from these quantities, which results in the following measures being initiated:

1. The firing pulses are immediately disabled in the SINAMICS DC MASTER
2. The converter sends a “turn-off command” to SIMOREG CCP (via the serial interface).
3. SIMOREG CCP turns off the thyristors by connecting the pre-charged quenching capacitors anti-parallel to all thyristors. As a consequence, the current commutates from the converter into SIMOREG CCP. The quenching capacitors are initially discharged by the currents that they accept and they are then charged with the reverse polarity. The armature current starts to decrease as soon as the voltage of the quenching capacitors has reached the value of the motor EMF. However, the armature voltage continues to increase. As soon as it has reached the limit value, resistors are switched-in, which absorb the energy fed back from the motor during the remaining time of the current reduction phase.
4. A fault message is initiated in the SINAMICS DC MASTER.
5. The SIMOREG CCP re-charges the quenching capacitors with the reverse polarity so that a new quenching operation is possible.

Each time that the line supply voltage is switched in (e.g. via a line contactor), SIMOREG CCP requires approximately 3 s until it is ready for use as the quenching capacitors must first be charged up.

After a quenching operation, SIMOREG CCP requires a certain time until it is ready for use again. The duration depends on the operations during the quenching process and immediately afterwards. On one hand, the quenching capacitors in SIMOREG CCP must be charged to the required value with the reverse polarity (approx. 10 s). On the other hand, the chopper resistors, that convert the energy into heat when the armature current is reduced, require a cooling time calculated using an algorithm in the software. Depending on the amount of energy that was dissipated, this can take up to approx. 20 min.

SINAMICS DC MASTER has setting and monitoring parameters for commissioning, operation, monitoring and diagnostics of the SIMOREG CCP. The state of the SIMOREG CCP is signaled via connectors and the triggering of the SIMOREG CCP or erroneous states are signaled using fault and alarm messages.

Data is exchanged between the SINAMICS DC MASTER and SIMOREG CCP via the serial interface.

Integration

SINAMICS DC MASTER – SIMOREG CCP

The following table lists the SIMOREG CCP units that are suitable for the particular SINAMICS DC MASTER.

This information is based on the rated unit data (taking into consideration the particular limit values) of the components and on the other hand, typical rated data for Siemens DC motors from Catalog DA 12 · 2008.

Note:

For plant and system configurations with reduced rated values (e.g. DC rating, US rating, voltage derating), under certain circumstances, suitable combinations of units can be found that are not listed in the table.

For detailed engineering and when selecting the appropriate CCP, our technical support personnel can provide you with help through the local Siemens office. Please specify the following plant or system data:

- Line supply voltages and power sections
- Required undervoltage range of the power section
- Rated motor armature voltage
- Rated motor current
- Details on the required overcurrent where necessary (magnitude, cycle duration)
- Inductance of the load (motor, cable plus if required a smoothing reactor)

SINAMICS DC MASTER			SIMOREG CCP		
Type	Rated DC voltage V	Rated DC current A	Type	Rated voltage V	Rated current A
6RA8078-6DV62-0AA0	420	280	6RA7085-6FC00-0	460 V 3 AC	DC 600
6RA8081-6DV62-0AA0		400			
6RA8085-6DV62-0AA0		600			
6RA8078-6FV62-0AA0	480	280	6RA7091-6FC00-0		DC 1 200
6RA8082-6FV62-0AA0		450			
6RA8085-6FV62-0AA0		600			
6RA8085-6DV62-0AA0	420	600	6RA7095-6FC00-0		DC 2 000
6RA8087-6DV62-0AA0		850			
6RA8091-6DV62-0AA0		1 200			
6RA8085-6FV62-0AA0	480	600	6RA7090-6KC00-0	690 V 3 AC	DC 1 000
6RA8087-6FV62-0AA0		850			
6RA8091-6FV62-0AA0		1 200			
6RA8091-6DV62-0AA0	420	1 200	6RA7095-6KC00-0		DC 2 000
6RA8093-4DV62-0AA0		1 600			
6RA8095-4DV62-0AA0		2 000			
6RA8081-6GV62-0AA0	600	400	6RA7095-6KC00-0		DC 2 000
6RA8085-6GV62-0AA0		600			
6RA8087-6GV62-0AA0		850			
6RA8086-6KV62-0AA0	725	760	6RA7095-6KC00-0		DC 2 000
6RA8090-6KV62-0AA0		1 000			
6RA8090-6GV62-0AA0	600	1 100			
6RA8093-4GV62-0AA0		1 600	6RA7095-6KC00-0		DC 2 000
6RA8095-4GV62-0AA0		2 000			
6RA8090-6KV62-0AA0	725	1 000			
6RA8093-4KV62-0AA0		1 500	6RA7095-6KC00-0		DC 2 000
6RA8095-4KV62-0AA0		2 000			

SINAMICS DCM

Accessories and supplementary components

SIMOREG CCP

Technical specifications

		SIMOREG CCP				
		Type				
		6RA7085-6FC00-0	6RA7091-6FC00-0	6RA7095-6FC00-0	6RA7090-6KC00-0	6RA7095-6KC00-0
Rated voltage	V	460 (+15 %/-20 %)			690 (+10 %/-20 %)	
Rated current	A	600	1 200	2 000	1 000	2 000
Current range that can be covered ¹⁾	A	up to 600	up to 1 200	up to 2 000	up to 1 000	up to 2 000
Rated supply voltage, electronics power supply	V	380 (-20 %) ... 60 V (+15 %) 2 AC; $I_n = 1$ A or 190 (-20 %) ... 230 V (+15 %) 1 AC; $I_n = 2$ A				
Rated frequency	Hz	45 ... 65				
Power loss	W	100				
Ambient temperature						
• Operation	°C	0 ... 55				
• Storage and transport	°C	-25 ... +70				
Installation altitude above sea level	m	≤ 1 000 m				
Climate class		3K3 acc. to EN 60721-3-3				
Degree of pollution		2 acc. to EN 50178 ²⁾				
Degree of protection		IP00 acc. to EN 60529				
Dimensions						
• Width	mm	406				
• Height	mm	780				
• Depth	mm	500				
Weight, approx.	kg	35	35	55	45	75
Fuse for connections 1U1, 1V1, 1W1 and 1D1		3NA3365-6 1 each	3NA3365-6 1 each	3NA3365-6 2 each in parallel	3NA3365-6 1 each	3NA3365-6 2 each in parallel
Fuse for connections 2U1, 2V1, 2W1 (10 A cable protection)		DIAZED 5SD604				

¹⁾ The current range that can be covered corresponds to the actual rated current of the SINAMICS DC MASTER. When the rated current is reduced (via parameter) then the lower value obtained applies. This means that for a SINAMICS DC MASTER with (according to the type plate) a rated current higher than 2 000 A (necessary e.g. to maintain longer specified overload times), it is possible to use the CCP if the actual rated current, specified by the parameterization, does not exceed 2 000 A. The possible overload capability of 1.8x the actual rated current can be additionally utilized.

²⁾ Definition of pollution degree 2:
Generally only non-conductive pollution occurs. However, occasionally conductive pollution can be expected for a short period of time if the electronic equipment is not operational.

Technical specifications (continued)

General technical data			
Relevant standards			
EN 50178	Electronic equipment for use in power installations		
EN 50274	Low-voltage switchgear and controlgear assemblies: Protection against electric shock – Protection against unintentional direct contact with hazardous live parts		
EN 60146-1-1	Semiconductor converters: General requirements and line-commutated converters; specification of basic requirements		
EN 61800-1	Adjustable speed electrical power drive systems, Part 1 – (DC drives) General requirements – Rating specifications for low-voltage DC power drive systems		
EN 61800-3	Adjustable speed electrical power drive systems, Part 3 – EMC product standard including specific test methods		
EN 61800-5-1	Adjustable speed electrical power drive systems – Part 5-1: Requirements regarding safety – electrical, thermal, and energy requirements		
IEC 62103 (identical to EN 50178)	Electronic equipment for use in power installations		
UBC 97	Uniform Building Code		
Mechanical strength	Storage	Transport	Operation
Vibratory load	1M2 acc. to EN 60721-3-1 (dropping not permissible)	2M2 acc. to EN 60721-3-2 (dropping not permissible)	Constant deflection: 0.075 mm at 10 to 58 Hz Constant acceleration: 10 m/s ² at > 58 to 200 Hz (testing and measuring techniques acc. to EN 60068-2-6, Fc)
Shock load			100 m/s ² at 11 ms (testing and measuring techniques acc. to EN 60068-2-27, Ea)
Approvals			
UL/cUL	UL file No.: E145153		
UL 508 C (UL Standard for Power Conversion Equipment)	Certification of the units up to and including 575 V		
GOST			

Selection and ordering data

Rated voltage	Rated current	SIMOREG CCP
V	A	Order No.
460	600	6RA7085-6FC00-0
	1 200	6RA7091-6FC00-0
	2 000	6RA7095-6FC00-0
690	1 000	6RA7090-6KC00-0
	2 000	6RA7095-6KC00-0

Accessories

Description	Order No.
Operating Instructions for SIMOREG CCP in printed form <ul style="list-style-type: none"> English, German French, Italian, Spanish 	6RX1700-0DD74 (from Edition 04) 6RX1700-0DD83 (from Edition 04)
Operating Instructions for SINAMICS DC MASTER and SIMOREG CCP on DVD English, French, German, Italian, Spanish, Russian ¹⁾	6RX1800-0AD64 (for SIMOREG CCP from Edition 04)
Patch cable UTP CAT5 according to ANSI/EIA/TIA 568 Parallel patch cable for SINAMICS DC MASTER and SIMOREG CCP, approx. 5 m, connecting cable, pulse blocking interface to connected SIMOREG CCPs in parallel, connecting cable, pulse blocking interface to the SINAMICS DC MASTER	6RY1707-0AA08
FiringUnitTrigger Board Printed circuit board to inhibit the firing pulses for a parallel connection	6RY1803-0CP00

¹⁾ However Russian not for SIMOREG CCP.

SINAMICS DCM

Accessories and supplementary components

SIMOREG CCP

Schematics

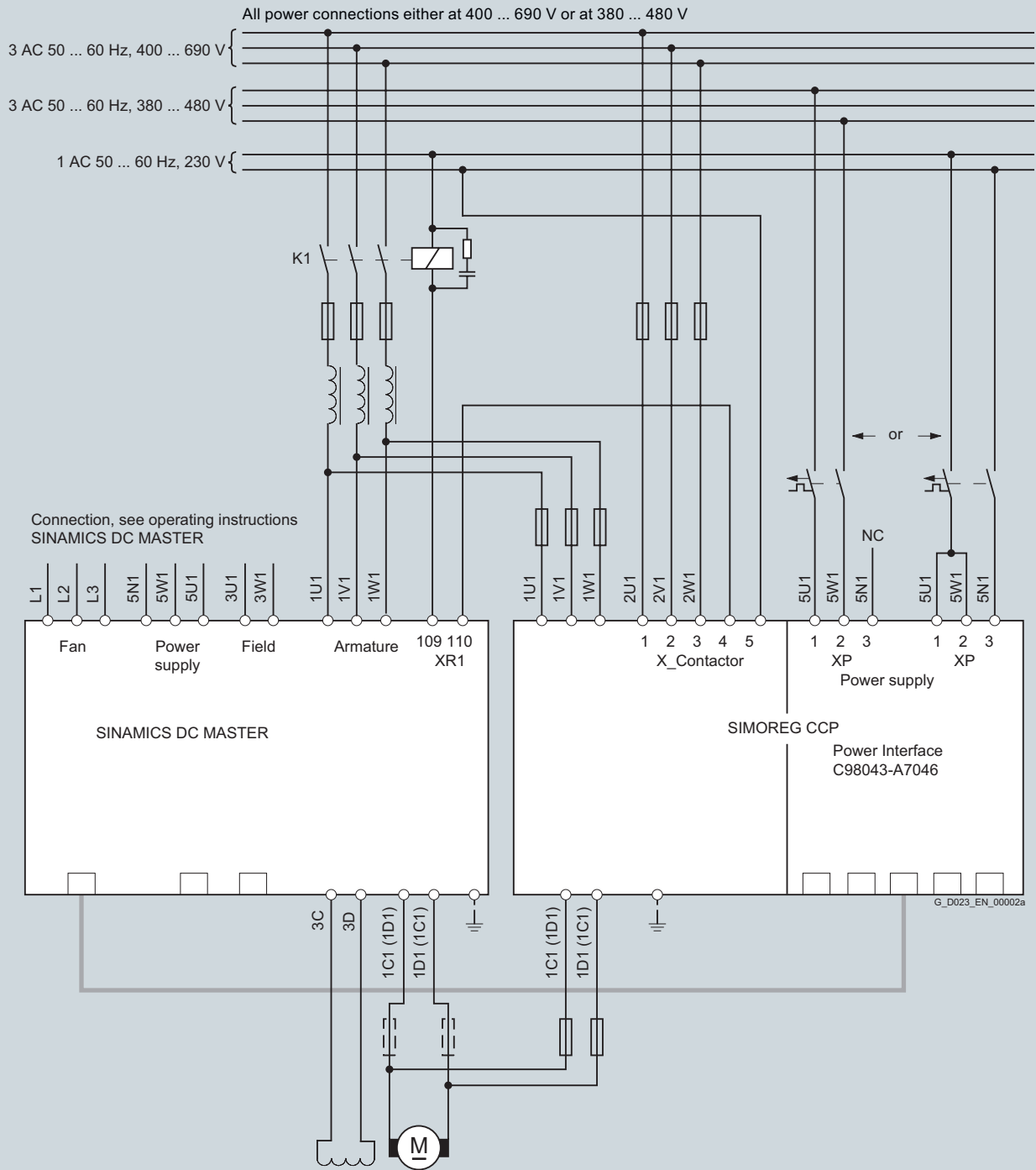

Block diagram

Operation without a main contactor is not permissible. The control voltage for the main contactor (or the circuit-breaker) must always be routed via terminal XR (connection 109 and 110) of the SINAMICS DC MASTER unit and via terminal X_Contactor (connections 4 and 5) of the SIMOREG CCP.

For applications with SIMOREG CCP, in the case of a fault, the converter or SIMOREG CCP must be able to disconnect safely from the line supply. Further, it must be ensured that the total of the delay times of all of the switching elements in the control circuit must not exceed the time set using the corresponding parameters. When SINAMICS DC MASTER units are connected in parallel, each unit is directly connected to a SIMOREG CCP in parallel (refer to the block diagram for the parallel connection).

Schematics (continued)

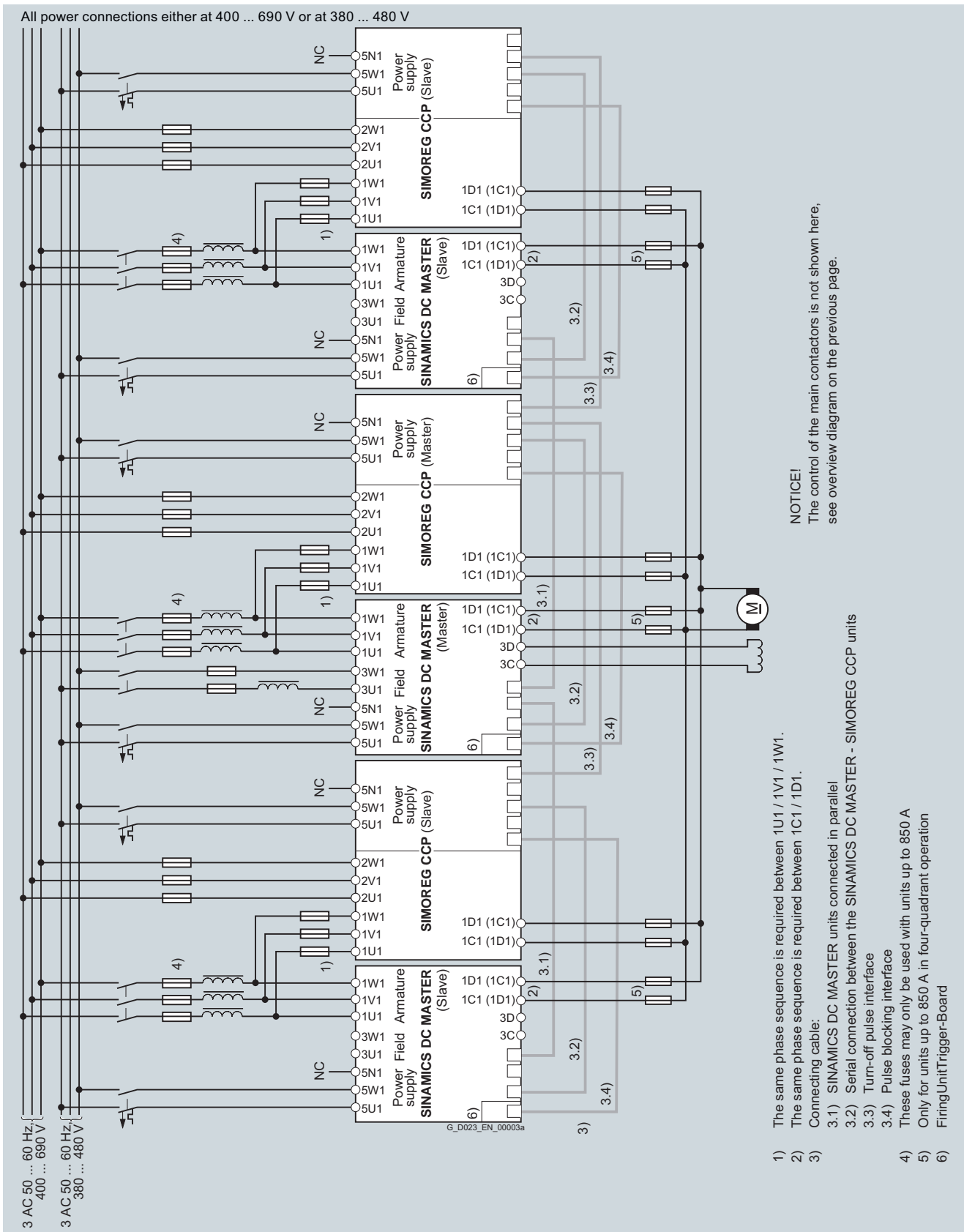

Block diagram for the parallel connection

SINAMICS DCM

Accessories and supplementary components

Notes

4

Engineering information



5/2	Dynamic overload capability
5/2	Overview
5/2	<ul style="list-style-type: none"> • Determining the dynamic overload capability
5/15	<ul style="list-style-type: none"> • Load classes
5/17	<ul style="list-style-type: none"> • Duty cycles for two-quadrant operation
5/18	<ul style="list-style-type: none"> • Duty cycles for four-quadrant operation
5/19	Parallel connection
5/19	Overview
5/19	<ul style="list-style-type: none"> • Parallel connection of SINAMICS DC MASTER units
5/20	12-pulse operation
5/20	Overview
5/20	<ul style="list-style-type: none"> • SINAMICS DC MASTER for 12-pulse operation
5/20	Supply of high inductances
5/20	Overview
5/20	<ul style="list-style-type: none"> • SINAMICS DC MASTER to supply high inductances
5/20	Protection against condensation
5/20	Overview
5/20	<ul style="list-style-type: none"> • Protection against condensation
5/21	Characteristic values of the pulse tachometer evaluation electronics
5/21	Overview
5/21	<ul style="list-style-type: none"> • Input pulse levels
5/21	<ul style="list-style-type: none"> • Switching frequency
5/21	<ul style="list-style-type: none"> • Cable, cable length, shield connection
5/22	Notes for EMC-compliant drive installation
5/22	Overview
5/22	<ul style="list-style-type: none"> • Notes for EMC-compliant installation
5/22	<ul style="list-style-type: none"> • Basic information about EMC
5/24	<ul style="list-style-type: none"> • EMC-compliant drive installation (installation instructions)
5/28	Harmonics
5/28	Overview
5/28	<ul style="list-style-type: none"> • Line-side harmonics produced by converter units in a fully-controlled three-phase bridge circuit B6C and (B6)A(B6)C

Overview

Determining the dynamic overload capability

Function overview

The rated DC current specified on the unit rating plate (maximum permissible continuous DC current) may be exceeded in operation. The extent to which this value is exceeded and how long this lasts are subject to certain limits, which are explained in more detail in the following.

The absolute upper limit for the value of the overload currents is 1.8x the rated DC current. The maximum overload duration depends on the time characteristic of the overload current as well as on the load history of the unit and also depends on the specific unit.

Each overload must be preceded by an underload (load phase with load current < rated DC current). Once the maximum permissible overload duration has elapsed, the load current must return to at least an absolute value \leq the rated DC current.

The dynamic overload duration is made possible by thermally monitoring the power section ($\hat{P}t$ monitoring). $\hat{P}t$ monitoring uses the time characteristic of the actual load current to calculate the time characteristic of a substitute value for the increase of the depletion layer temperature of the thyristors above the ambient temperature. In this case, unit-specific properties (e.g. thermal resistances and time constants) are incorporated in the calculation. When the converter unit is switched on, the calculation process starts with the initial values that were determined before the shutdown/line supply failure. The environmental conditions (ambient temperature and installation altitude) must be taken into account when setting a parameter.

$\hat{P}t$ monitoring responds when the calculated substitute depletion layer temperature rise exceeds the permissible value. Two alternatives can be parameterized as response:

- Alarm with a reduction of the armature current setpoint to the rated DC current or
- Fault with unit shutdown

$\hat{P}t$ monitoring can be disabled. In this case, the armature current is limited to the rated DC current.

Configuring for the dynamic overload capability

The configuring sheets contain the following information:

- The maximum overload duration t_{an} when starting with a cold power section and specified, constant overload,
- The maximum zero current interval t_{ab} (maximum cooling down time) until the "cold" thermal state of the power section is reached, and
- Fields of limiting characteristics for determining the overload capability during thermally stabilized, intermittent operation with overload (periodic duty cycles)

Remark: The power section is considered to be "cold" if the calculated substitute depletion layer temperature rise is less than 5% of its maximum permissible value. This state can be queried using a binary assignable output.

Structure of the fields of limiting characteristics for intermittent operation with overload

The fields of limiting characteristics refer to a duty cycle of the intermittent overload operation with a total duration (time period) of 300 s. Such a duty cycle comprises two time sections – the base-load duration (armature current actual value \leq rated DC current) and the overload duration (armature current actual value \geq rated DC current).

Each limiting characteristic represents a unit-specific maximum base-load current for a specific overload factor (limiting base-load current, specified as a % of the rated DC current) over the minimum base-load duration (limiting base-load duration). For the remaining duration of the duty cycle, the maximum permissible overload current is determined by the overload factor. If no limiting characteristic has been specified for the required overload factor, then it will be subject to the limiting characteristic for the next highest overload factor.

The fields of limiting characteristics are valid for a duty cycle of 300 s. Using basic calculation algorithms, duty cycles can be configured with duty cycle durations of longer than or shorter than 300 s. This will now be shown using two basic tasks.

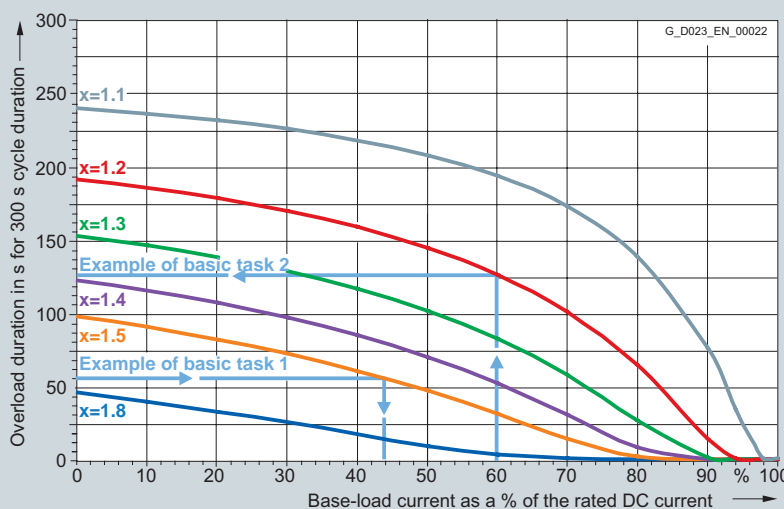

Characteristic example for basic tasks 1 and 2

Overview (continued)

Basic task 1

- Given:
Unit, cycle duration, overload factor, overload duration
- To be found:
(Min.) base-load duration and max. base-load current
- Solution:

	Cycle duration	
	< 300 s	≥ 300 s
1. Determine the characteristic	Select the limiting characteristic for the specific unit and the specific overload factor	
2. Overload duration ₃₀₀ =	300 s/cycle duration × overload duration	Overload duration ₃₀₀
3. Base-load duration ₃₀₀ =	300 s – overload duration ₃₀₀	
4. Base-load duration ₃₀₀ < base-load duration ₃₀₀ for max. base-load current = 0	Yes: Required duty cycle cannot be configured No: Read the max. base-load current for overload duration ₃₀₀ from the limiting characteristic	
5. Determine the percentage for the base-load current	Read the percentage for the base-load currents from the diagram	

Example for basic task 1

- Given:
 - Unit with 30 A
 - Cycle duration 113.2 s
 - Overload factor 1.45
 - Overload duration 20 s
- To be found:
 - (Min.) base-load duration
 - Max. base-load current
- Solution:
 - Limiting characteristic for a unit with 30 A
 - Overload factor 1.5
 - Overload duration₃₀₀ = 300 s/113.2 s × 20 s = 53 s →
 - Max. base-load current = 44 % I_{rated} = 13.2 A

Basic task 2

- Given:
Unit, cycle duration, overload factor, base-load current
- To be found:
Maximum overload duration, minimum base-load duration
- Solution:

	Cycle duration	
	< 300 s	≥ 300 s
1. Determine the characteristic	Select the limiting characteristic for the specific unit and the specific overload factor	
2. Max. overload duration =	(Cycle duration/300 s) × overload duration ₃₀₀	300 s – base-load duration ₃₀₀
3. Min. base-load duration =	Cycle duration – max. overload duration	Cycle duration – max. overload duration

Example for basic task 2

- Given:
 - Unit with 30 A
 - Cycle duration 140 s
 - Overload factor 1.15
 - Base load current = 0.6 × I_{rated} = 18 A
- To be found:
 - Maximum overload duration
 - Minimum base-load duration

Solution:

- Limiting characteristic for a unit with 30 A
- Overload factor 1.2
- Base-load current = 60 % I_{rated} →
- Overload duration₃₀₀ = 127 s
- Max. overload duration = 140 s/300 s × 127 s = 59 s
- Min. base-load duration = 140 s - 59 s = 81 s

Base-load duration₃₀₀ = min. base-load duration for 300 s cycle duration (300 s overload duration)

Overload duration₃₀₀ = max. overload duration for 300 s cycle duration

SINAMICS DCM

Engineering information

Dynamic overload capability

Overview (continued)

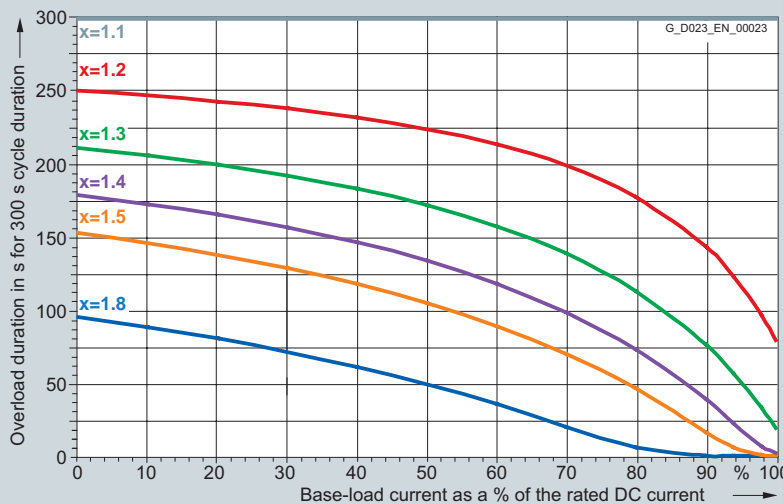

Overload with x-times rated DC current	t_{an} (s)
x=1.1	9227
x=1.2	1633
x=1.3	1112
x=1.4	833
x=1.5	651
x=1.8	342

t_{ab} (s) = 2303

6RA8013-6DV62-0AA0 15 A/four-quadrant operation 400 V, 6RA8013-6FV62-0AA0 15 A/four-quadrant operation 480 V

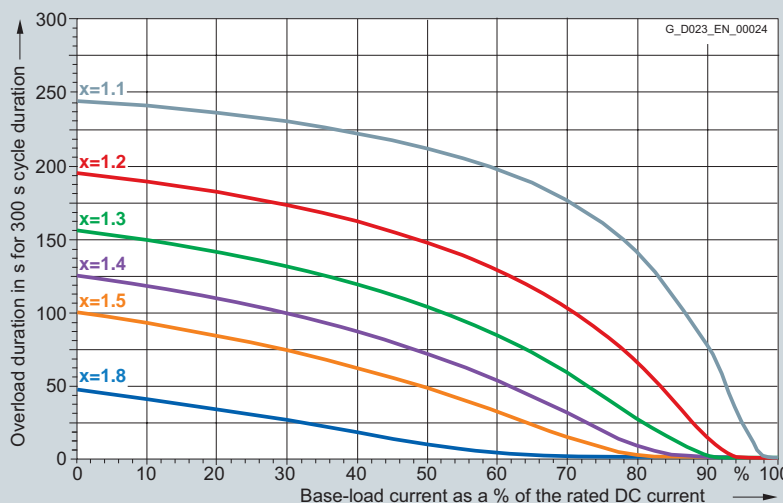

Overload with x-times rated DC current	t_{an} (s)
x=1.1	1438
x=1.2	906
x=1.3	631
x=1.4	455
x=1.5	333
x=1.8	123

t_{ab} (s) = 2193

6RA8018-6DV62-0AA0 30 A/four-quadrant operation 400 V, 6RA8018-6FV62-0AA0 30 A/four-quadrant operation 480 V

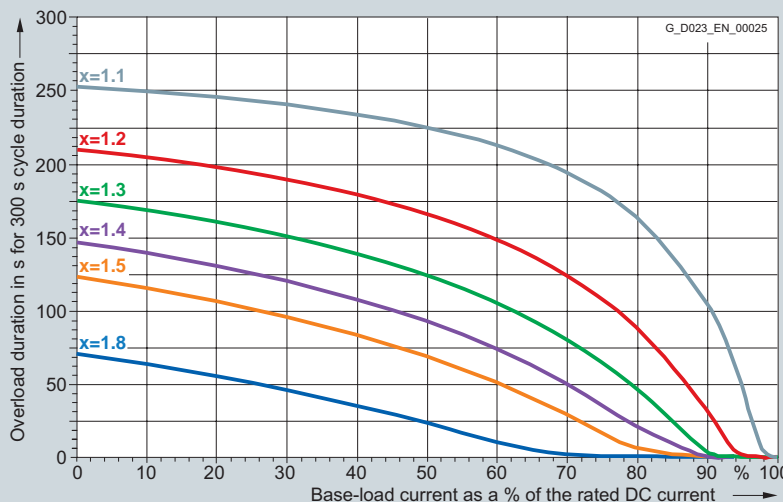

Overload with x-times rated DC current	t_{an} (s)
x=1.1	2081
x=1.2	1356
x=1.3	990
x=1.4	758
x=1.5	593
x=1.8	296

t_{ab} (s) = 2902

6RA8025-6DS22-0AA0 60 A/two-quadrant operation 400 V, 6RA8025-6FS22-0AA0 60 A/two-quadrant operation 480 V, 6RA8025-6GS22-0AA0 60 A/two-quadrant operation 575 V

Overview (continued)

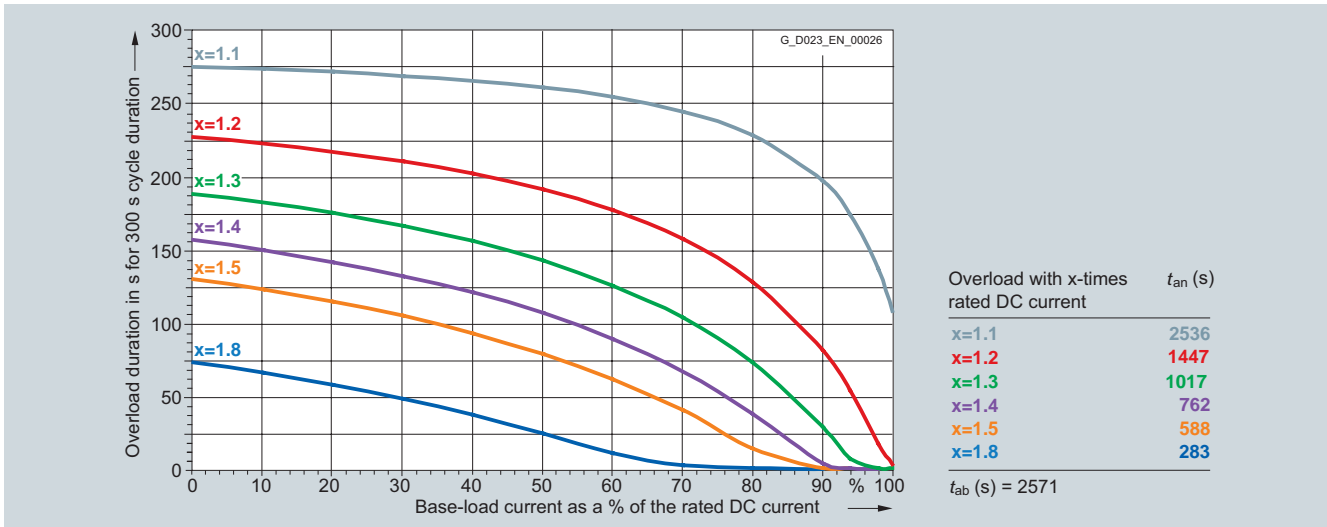

6RA8025-6DV62-0AA0 60 A/four-quadrant operation 400 V, 6RA8025-6FV62-0AA0 60 A/four-quadrant operation 480 V, 6RA8025-6GV62-0AA0 60 A/four-quadrant operation 575 V

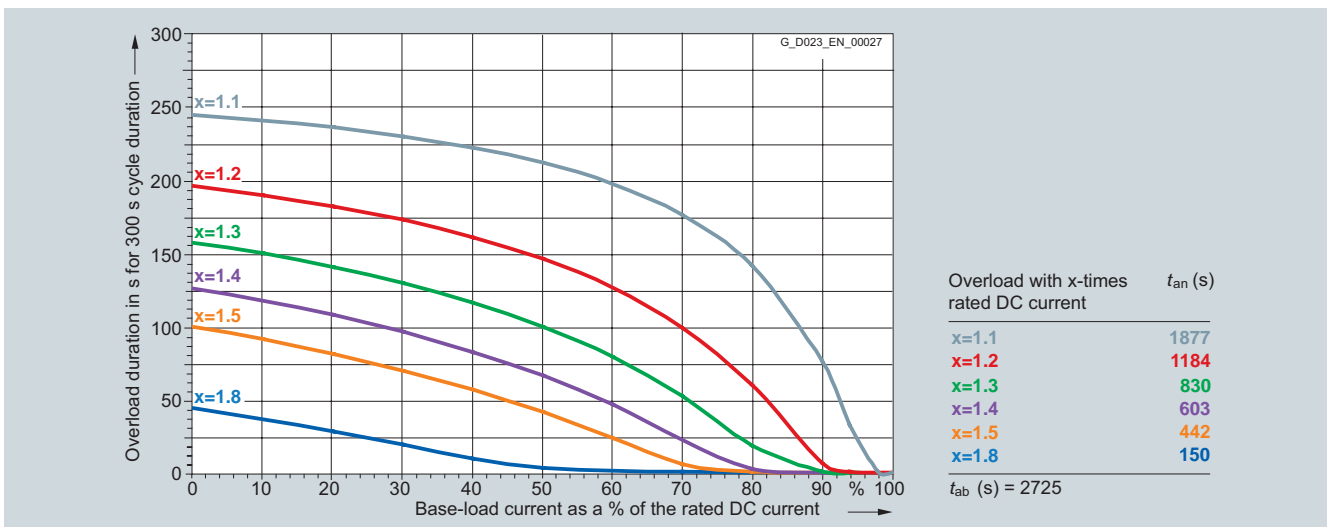

6RA8028-6DS22-0AA0 90 A/two-quadrant operation 400 V, 6RA8028-6FS22-0AA0 90 A/two-quadrant operation 480 V

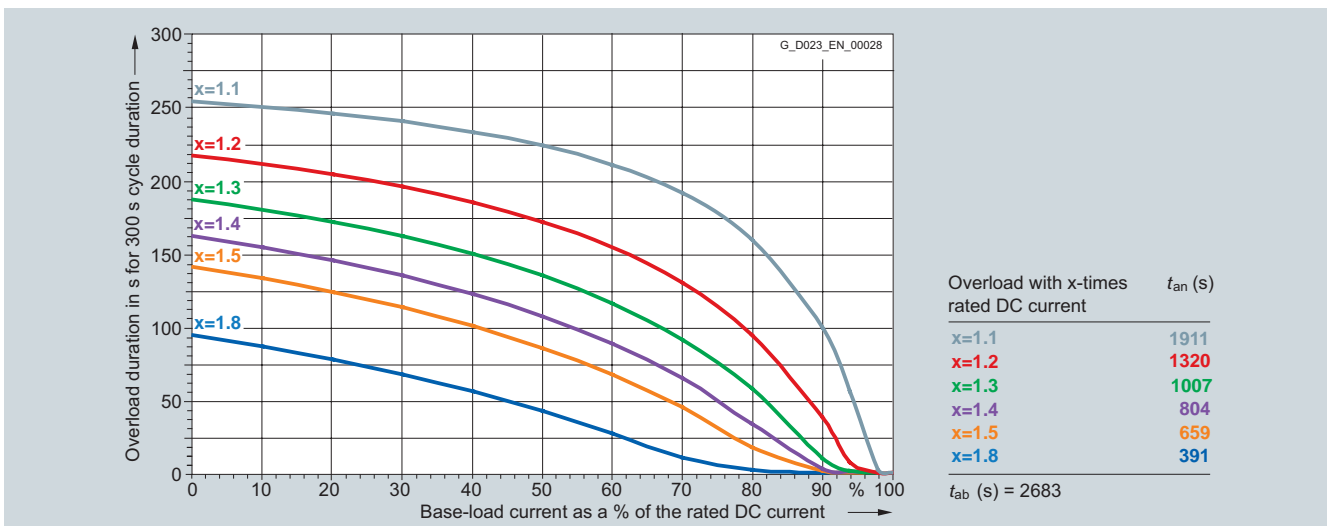

6RA8028-6DV62-0AA0 90 A/four-quadrant operation 400 V, 6RA8028-6FV62-0AA0 90 A/four-quadrant operation 480 V

SINAMICS DCM

Engineering information

Dynamic overload capability

Overview (continued)

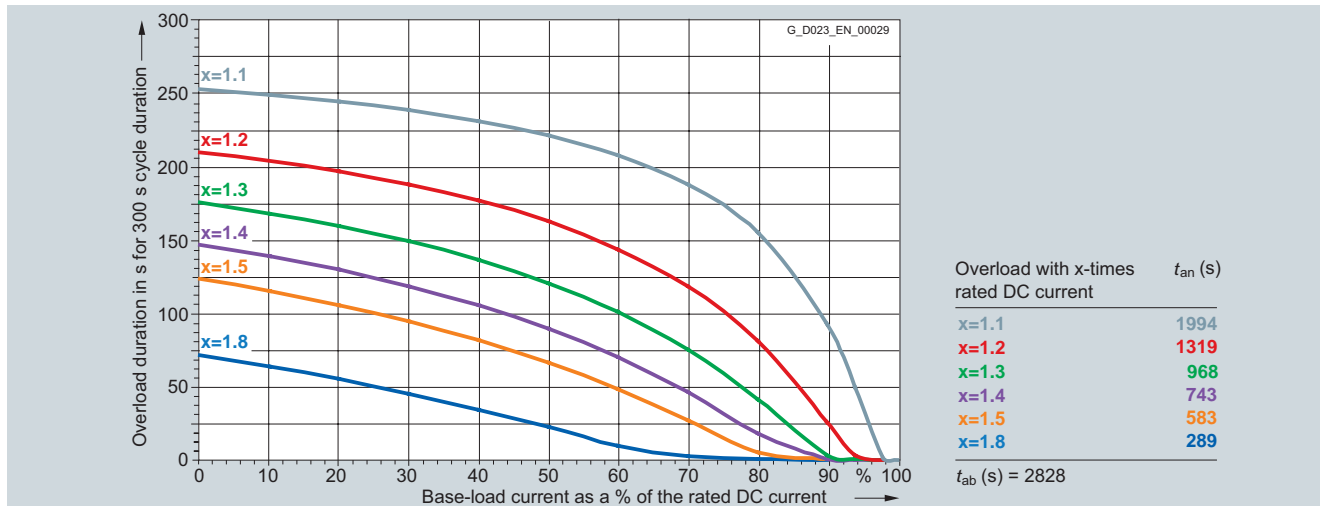

6RA8031-6DS22-0AA0 125 A/two-quadrant operation 400 V, 6RA8031-6FS22-0AA0 125 A/two-quadrant operation 480 V, 6RA8031-6GS22-0AA0 125 A/two-quadrant operation 575 V

5

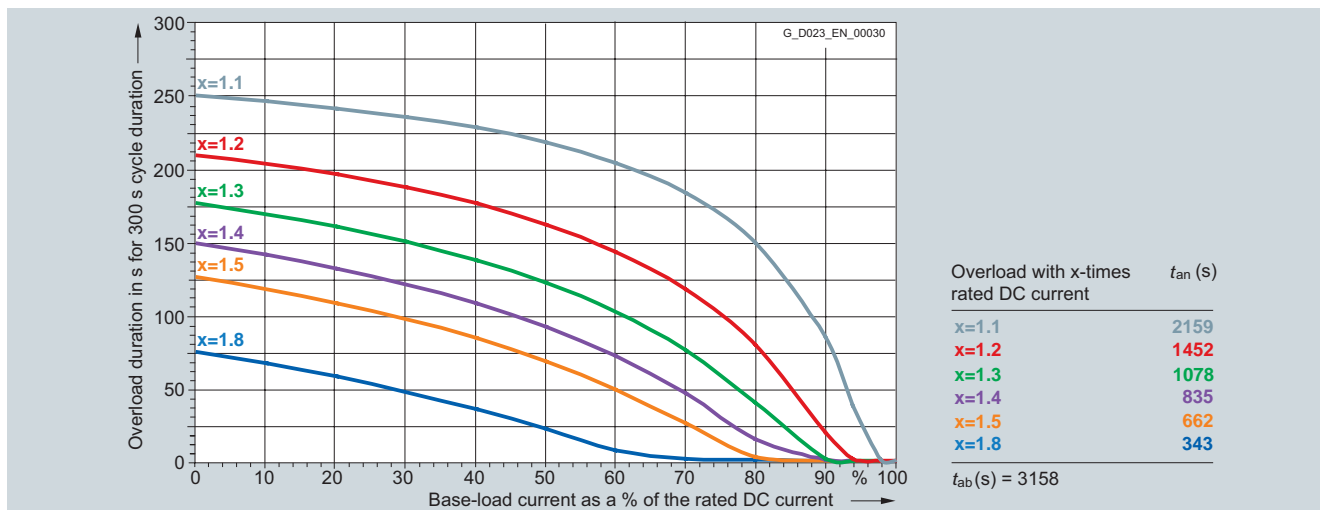

6RA8031-6DV62-0AA0 125 A/four-quadrant operation 400 V, 6RA8031-6FV62-0AA0 125 A/four-quadrant operation 480 V, 6RA8031-6GV62-0AA0 125 A/four-quadrant operation 575 V

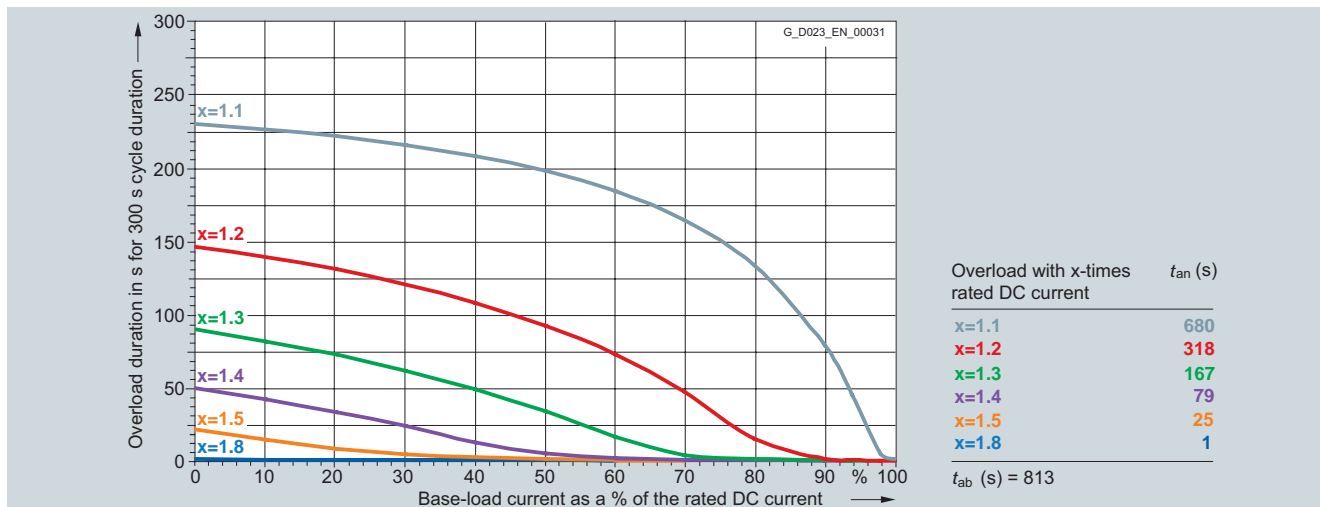

6RA8075-6DS22-0AA0 210 A/two-quadrant operation 400 V, 6RA8075-6DV62-0AA0 210 A/four-quadrant operation 400 V, 6RA8075-6FS22-0AA0 210 A/two-quadrant operation 480 V, 6RA8075-6FV62-0AA0 210 A/four-quadrant operation 480 V, 6RA8075-6GS22-0AA0 210 A/two-quadrant operation 575 V, 6RA8075-6GV62-0AA0 210 A/four-quadrant operation 575 V

Overview (continued)

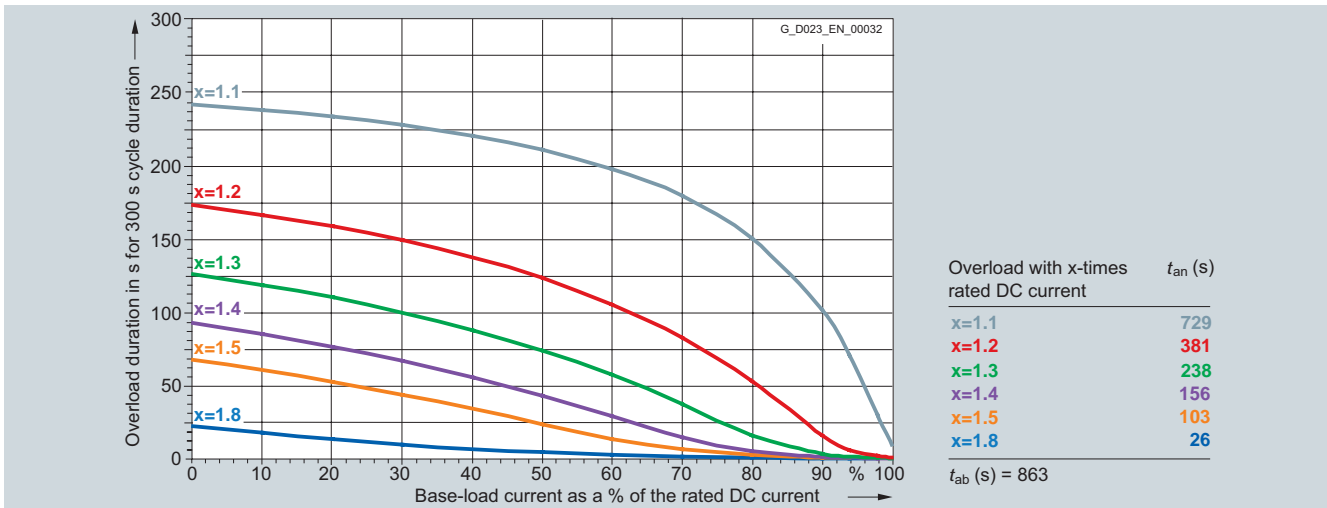

6RA8078-6DS22-0AA0 280 A/two-quadrant operation 400 V, 6RA8078-6DV62-0AA0 280 A/four-quadrant operation 400 V, 6RA8078-6FS22-0AA0 280 A/two-quadrant operation 480 V, 6RA8078-6FV62-0AA0 280 A/four-quadrant operation 480 V

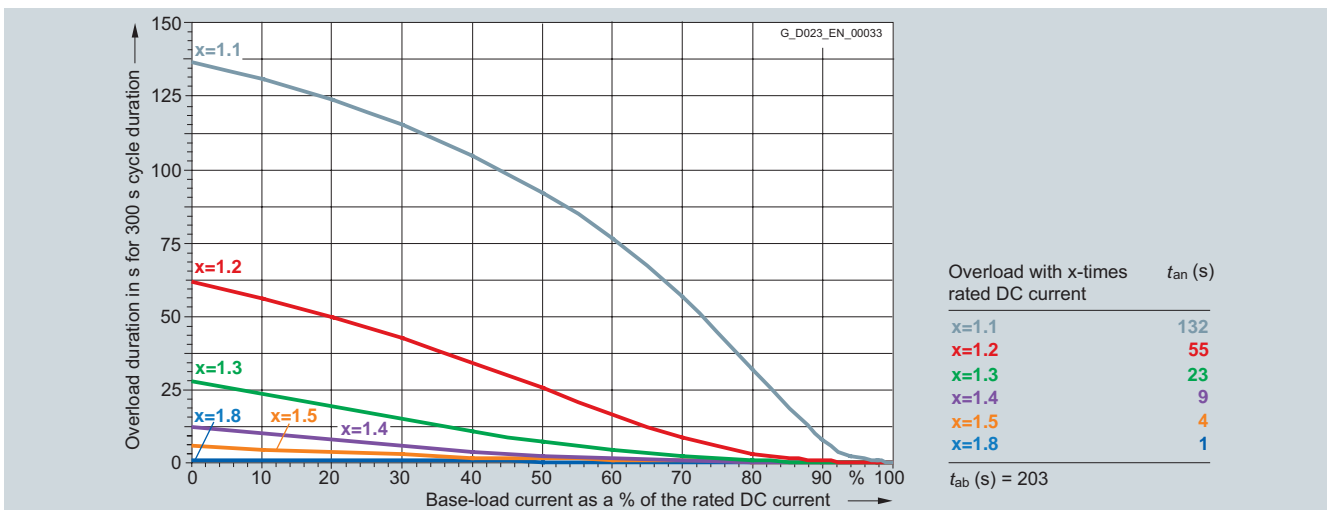

6RA8081-6DS22-0AA0 400 A/two-quadrant operation 400 V, 6RA8081-6GS22-0AA0 400 A/two-quadrant operation 575 V

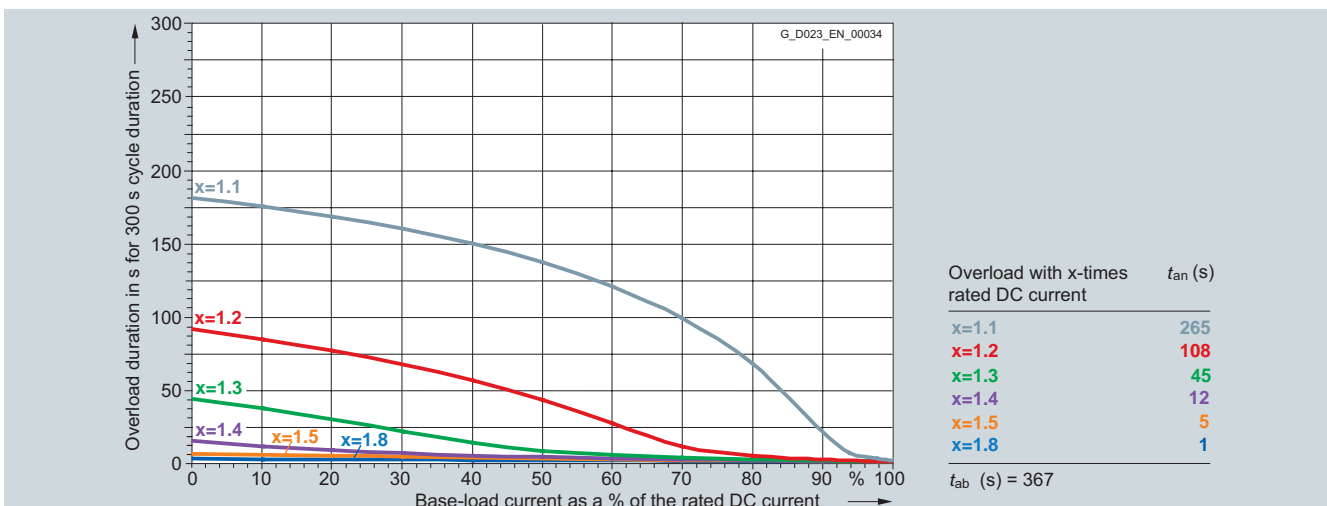

6RA8081-6DV62-0AA0 400 A/four-quadrant operation 400 V, 6RA8081-6GV62-0AA0 400 A/four-quadrant operation 575 V

SINAMICS DCM

Engineering information

Dynamic overload capability

Overview (continued)

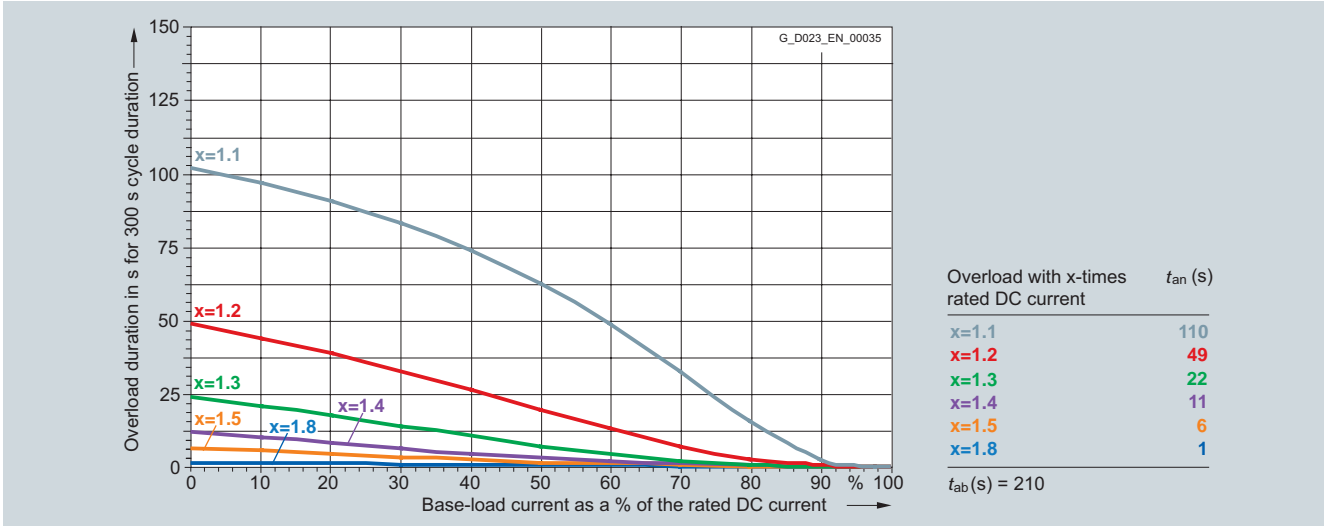

6RA8082-6FS22-0AA0 450 A/two-quadrant operation 480 V, 6RA8082-6FV62-0AA0 450 A/four-quadrant operation 480 V

5

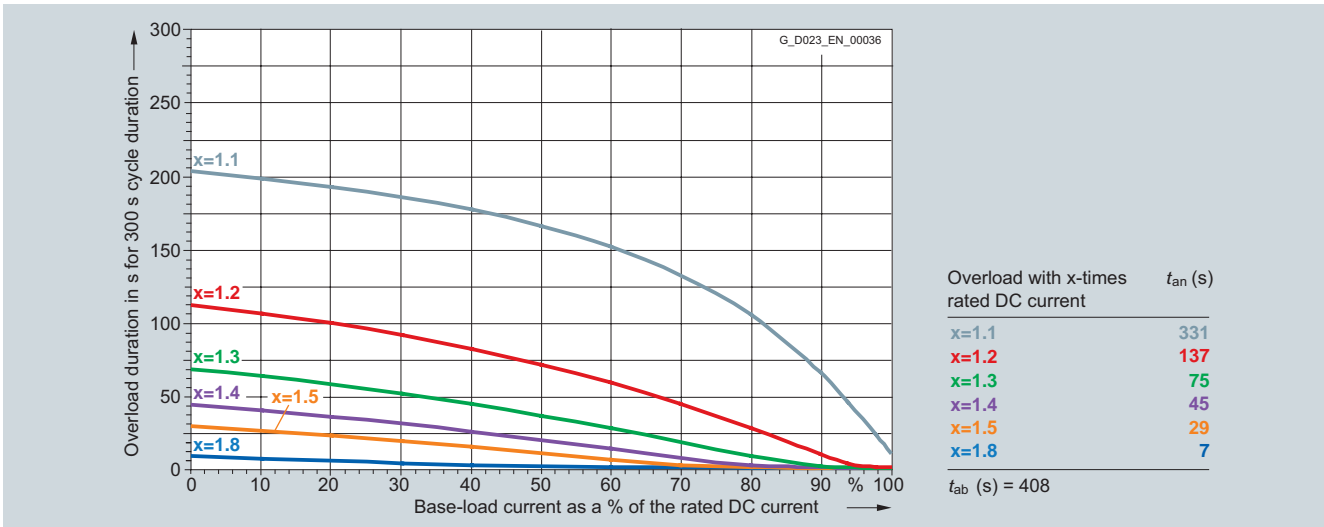

6RA8085-6DS22-0AA0 600 A/two-quadrant operation 400 V, 6RA8085-6FS22-0AA0 600 A/two-quadrant operation 480 V, 6RA8085-6GS22-0AA0 600 A/two-quadrant operation 575 V

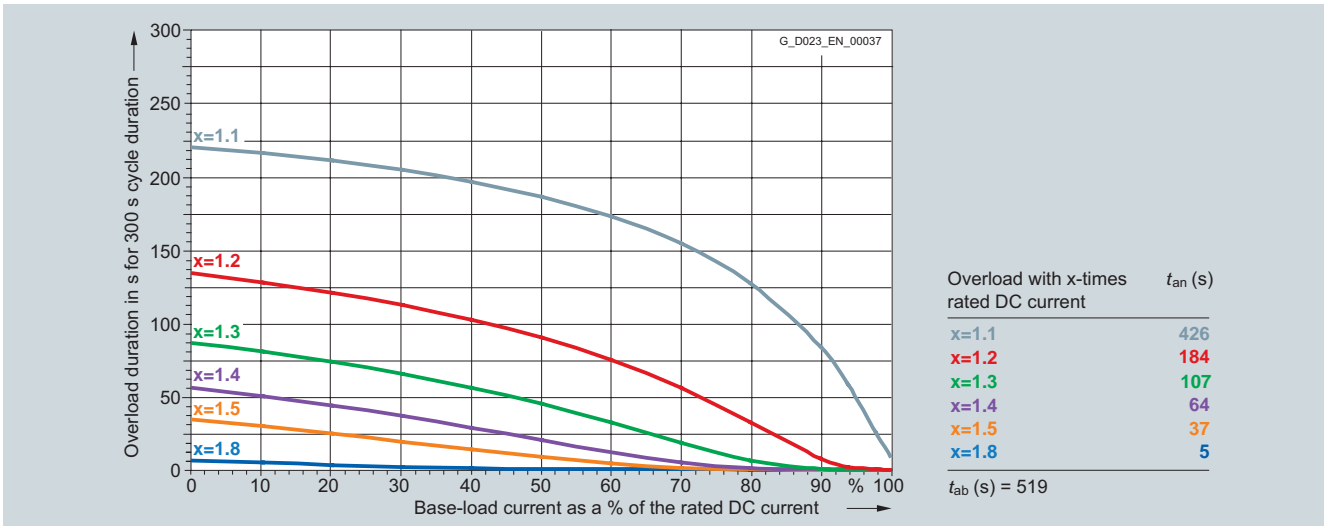

6RA8085-6DV62-0AA0 600 A/four-quadrant operation 400 V, 6RA8085-6FV62-0AA0 600 A/four-quadrant operation 480 V, 6RA8085-6GV62-0AA0 600 A/four-quadrant operation 575 V

Overview (continued)

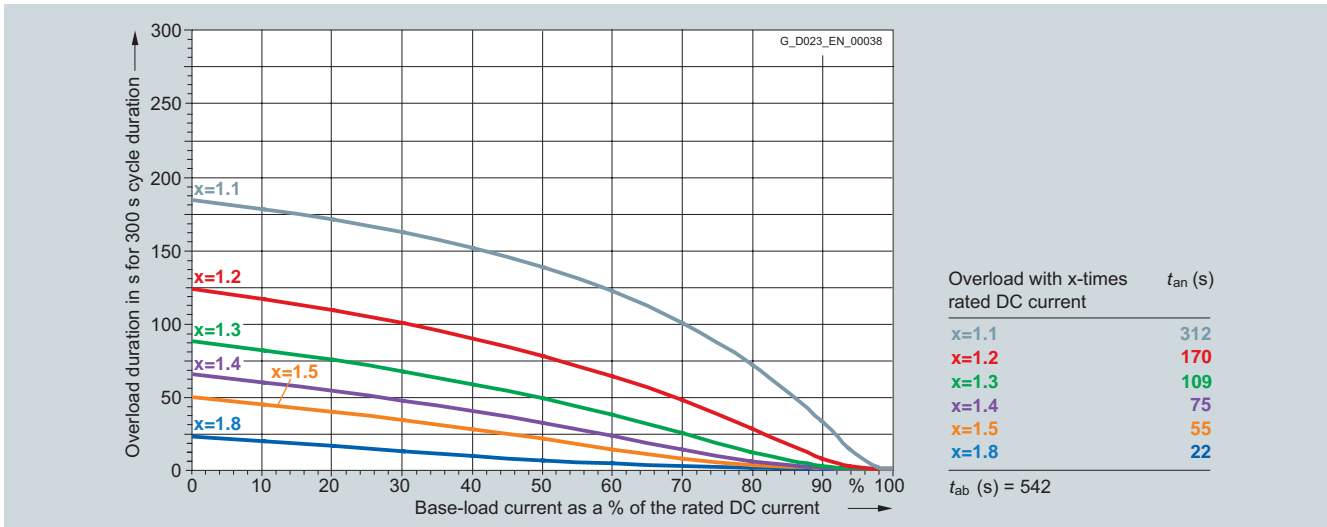

6RA8086-6KS22-0AA0 720 A/two-quadrant operation 690 V

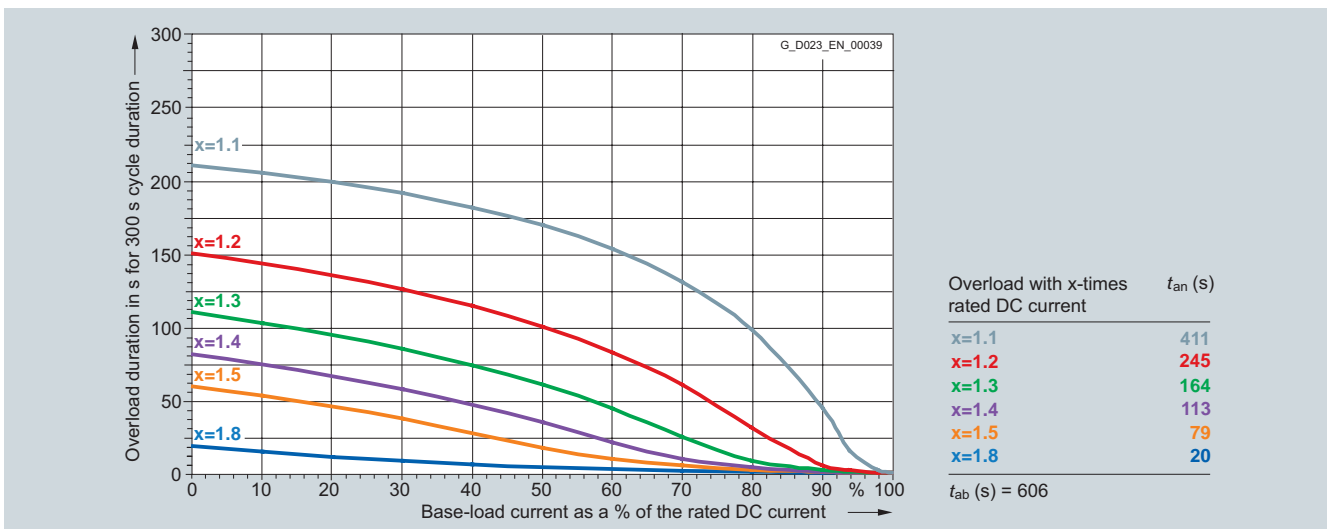

6RA8086-6KV62-0AA0 760 A/four-quadrant operation 690 V

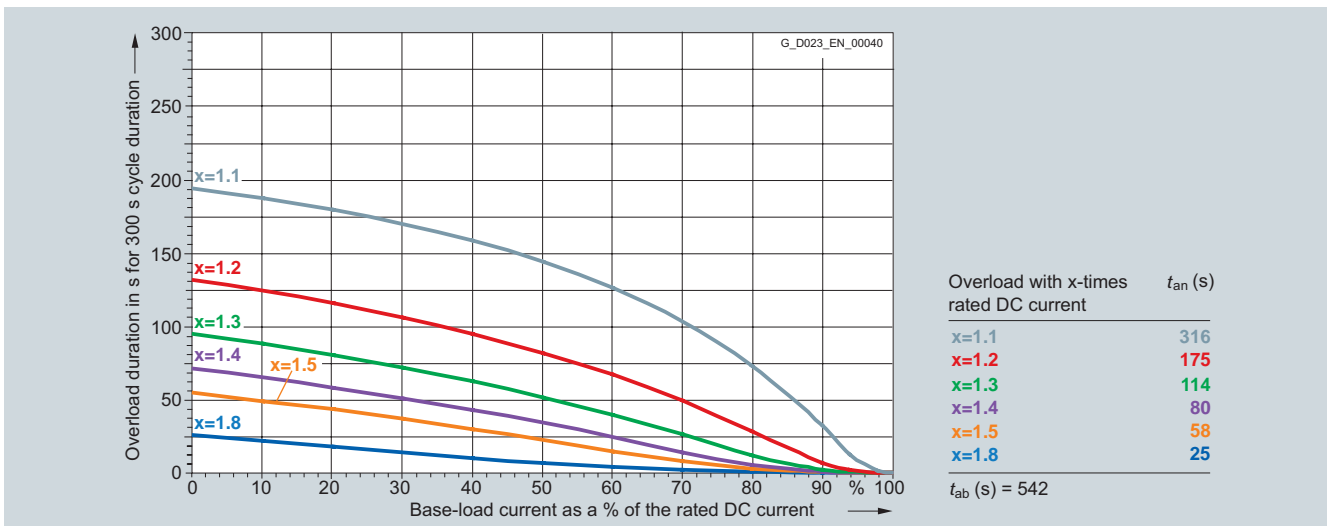

6RA8087-6DS22-0AA0 850 A/two-quadrant operation 400 V, 6RA8087-6FS22-0AA0 850 A/two-quadrant operation 480 V

SINAMICS DCM

Engineering information

Dynamic overload capability

Overview (continued)

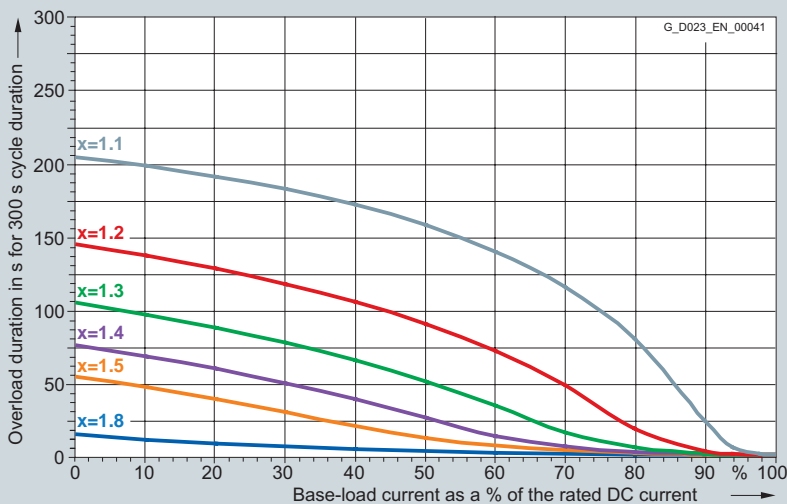

Overload with x-times rated DC current	t_{an} (s)
x=1.1	382
x=1.2	228
x=1.3	151
x=1.4	102
x=1.5	68
x=1.8	13

t_{ab} (s) = 593

6RA8087-6DV62-0AA0 850 A/four-quadrant operation 400 V, 6RA8087-6FV62-0AA0 850 A/four-quadrant operation 480 V, 6RA8087-6GV62-0AA0 850 A/four-quadrant operation 575 V

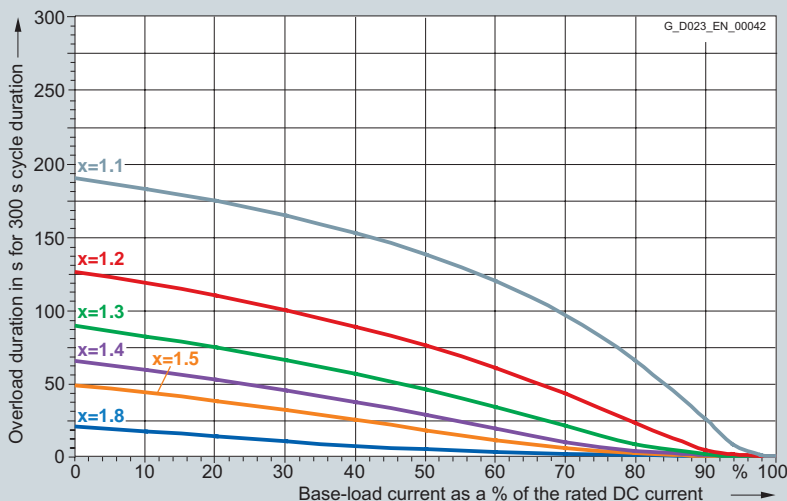

Overload with x-times rated DC current	t_{an} (s)
x=1.1	296
x=1.2	161
x=1.3	102
x=1.4	70
x=1.5	50
x=1.8	19

t_{ab} (s) = 527

6RA8087-6GS22-0AA0 800 A/two-quadrant operation 575 V

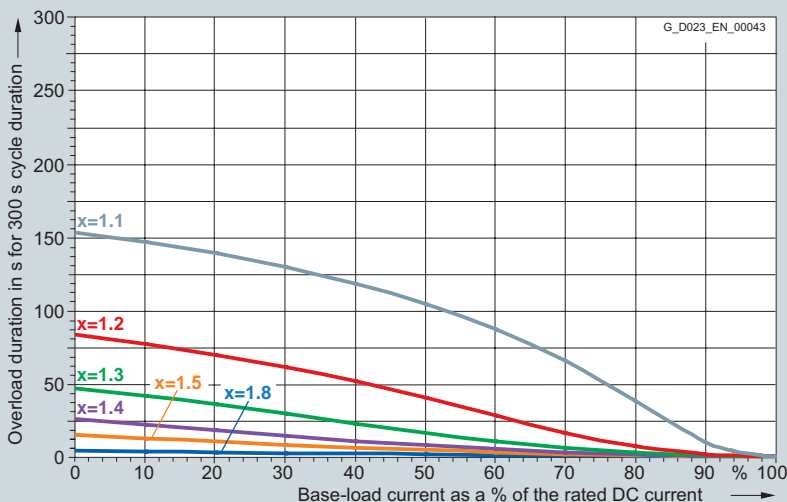

Overload with x-times rated DC current	t_{an} (s)
x=1.1	220
x=1.2	99
x=1.3	50
x=1.4	25
x=1.5	13
x=1.8	4

t_{ab} (s) = 395

6RA8088-6LS22-0AA0 950 A/two-quadrant operation 830 V, 6RA8088-6LV62-0AA0 950 A/four-quadrant operation 830 V

5

Overview (continued)

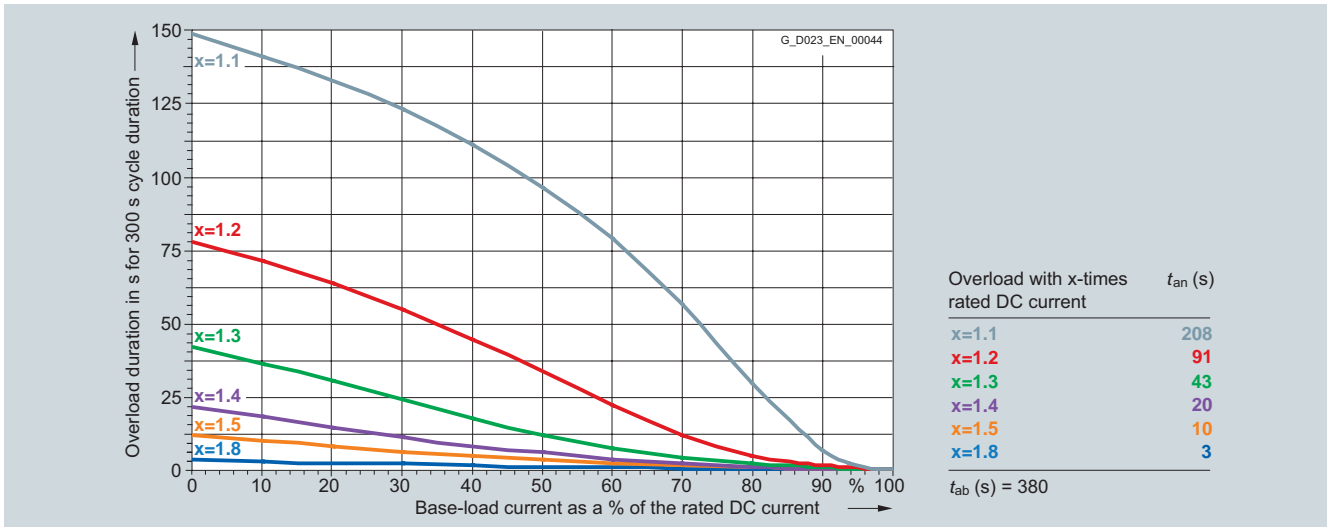

6RA8090-6GS22-0AA0 1 100 A/two-quadrant operation 575 V, 6RA8090-6GV62-0AA0 1 100 A/four-quadrant operation 575 V

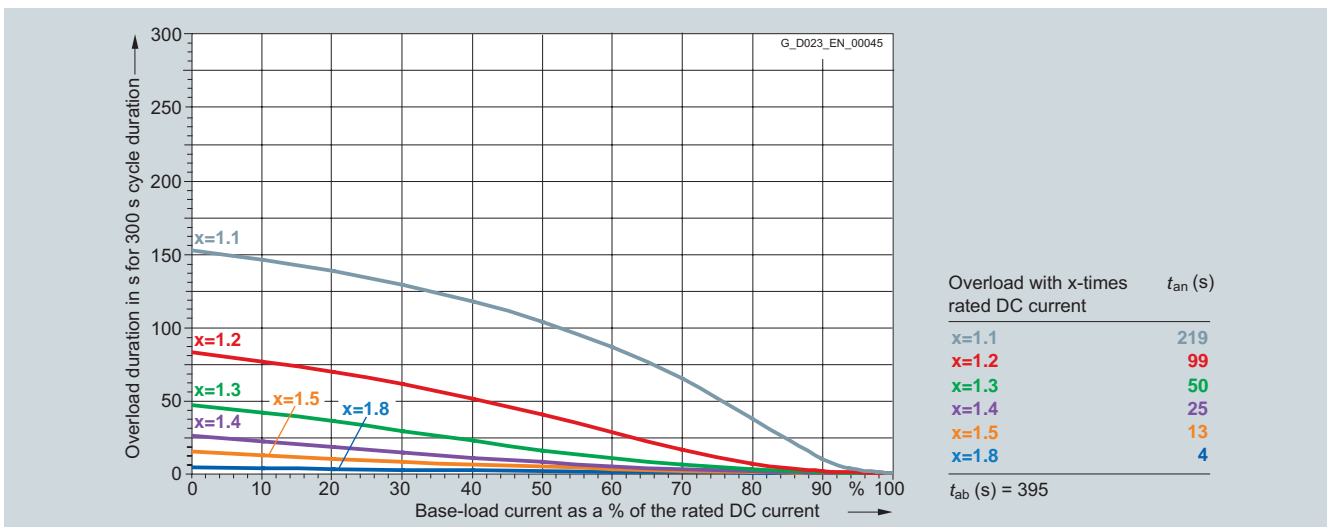

6RA8090-6KS22-0AA0 1 000 A/two-quadrant operation 690 V, 6RA8090-6KV62-0AA0 1 000 A/four-quadrant operation 690 V

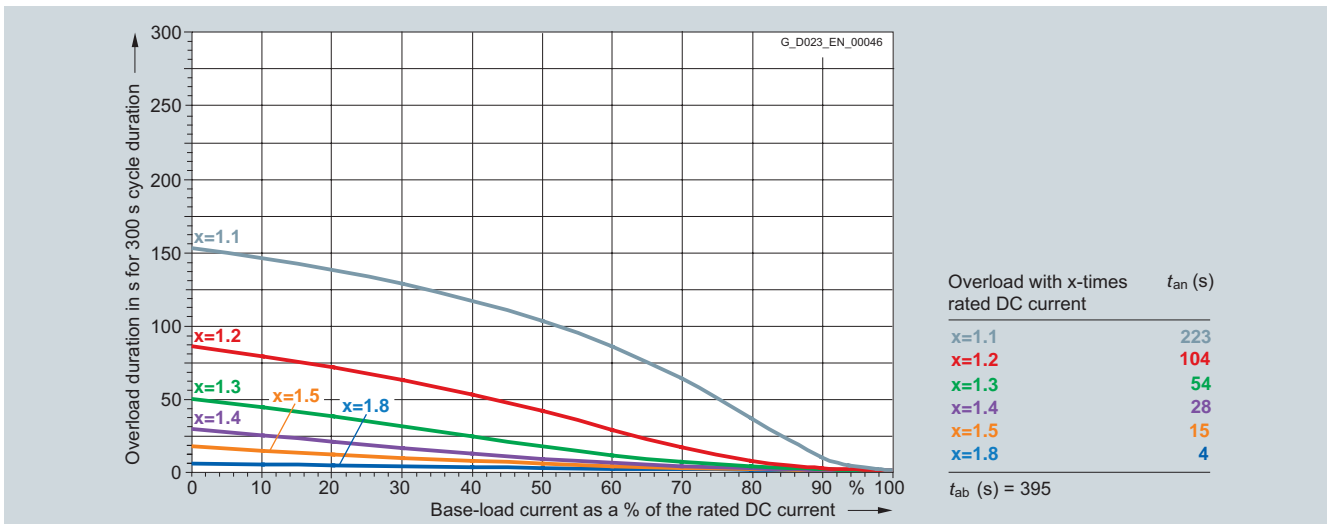

6RA8091-6DS22-0AA0 1 200 A/two-quadrant operation 400 V, 6RA8091-6FS22-0AA0 1 200 A/two-quadrant operation 480 V, 6RA8091-6FV62-0AA0 1 200 A/four-quadrant operation 480 V, 6RA8091-6DV62-0AA0 1 200 A/four-quadrant operation 400 V

SINAMICS DCM

Engineering information

Dynamic overload capability

Overview (continued)

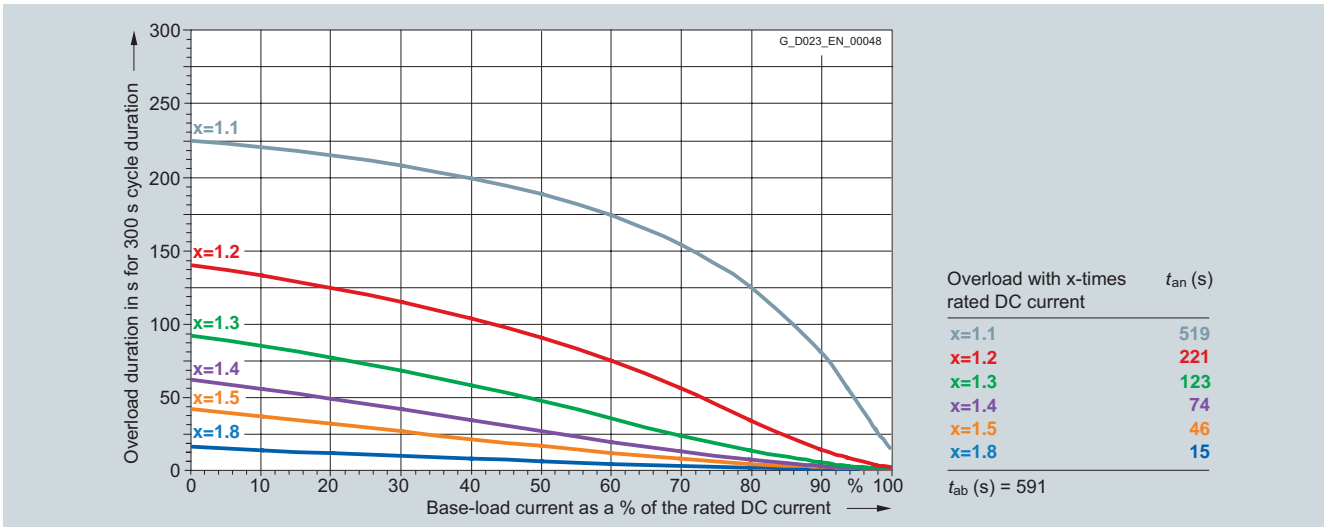

6RA8093-4DS22-0AA0 1 600 A/two-quadrant operation 400 V, 6RA8093-4DV62-0AA0 1 600 A/four-quadrant operation 400 V, 6RA8093-4GS22-0AA0 1 600 A/two-quadrant operation 575 V, 6RA8093-4GV62-0AA0 1 600 A/four-quadrant operation 575 V

5

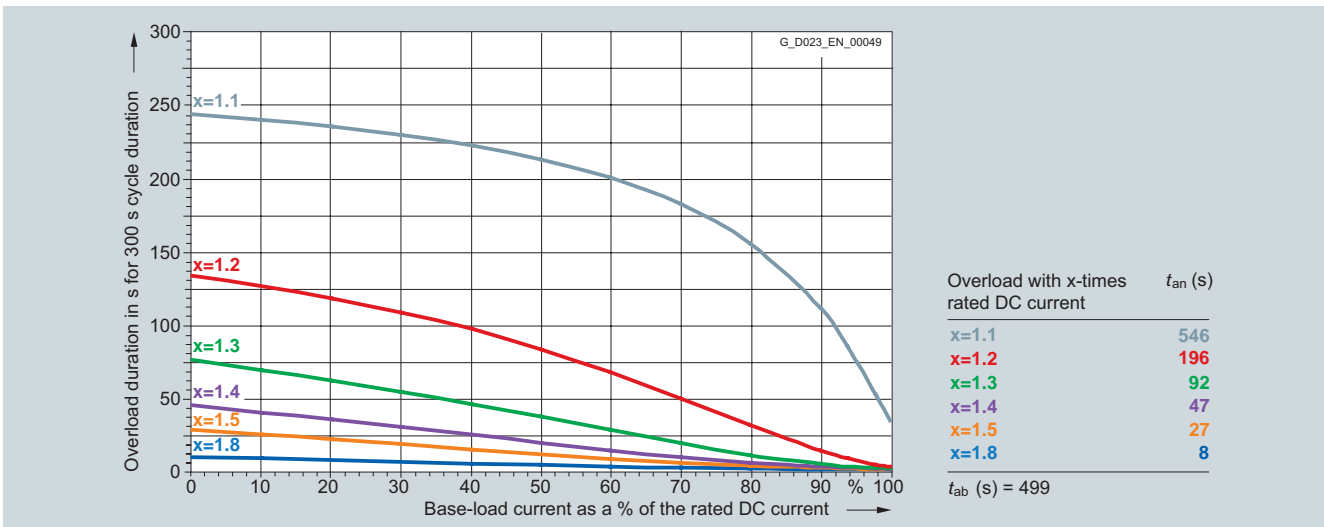

6RA8093-4KS22-0AA0 1 500 A/two-quadrant operation 690 V, 6RA8093-4KV62-0AA0 1 500 A/four-quadrant operation 690 V, 6RA8093-4LS22-0AA0 1 500 A/two-quadrant operation 830 V, 6RA8093-4LV62-0AA0 1 500 A/four-quadrant operation 830 V

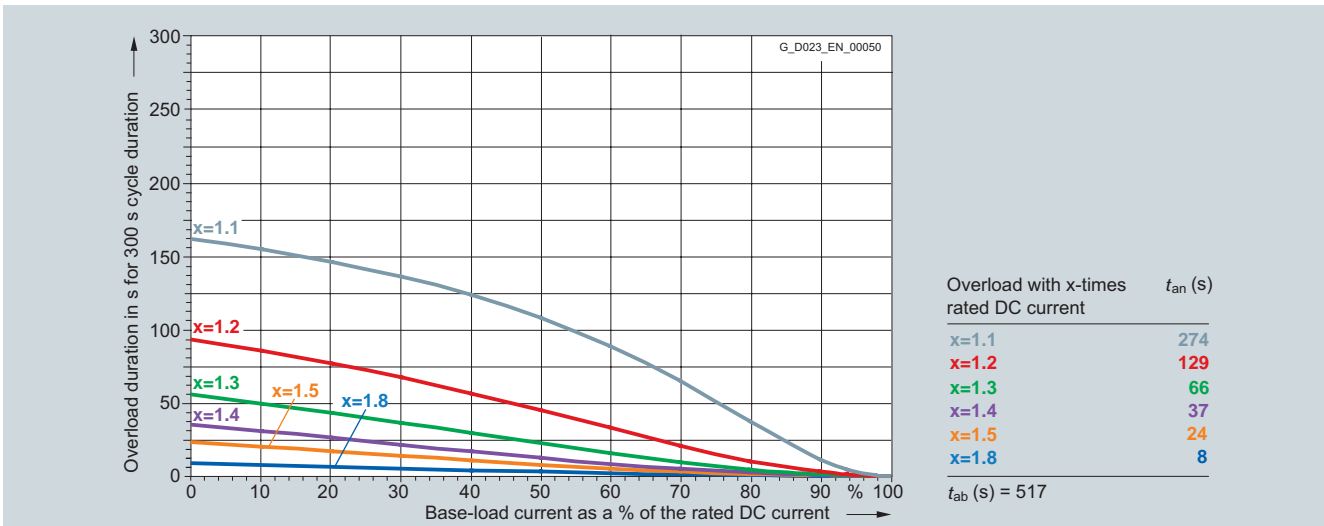

6RA8095-4DS22-0AA0 2 000 A/two-quadrant operation 400 V, 6RA8095-4DV62-0AA0 2 000 A/four-quadrant operation 400 V

Overview (continued)

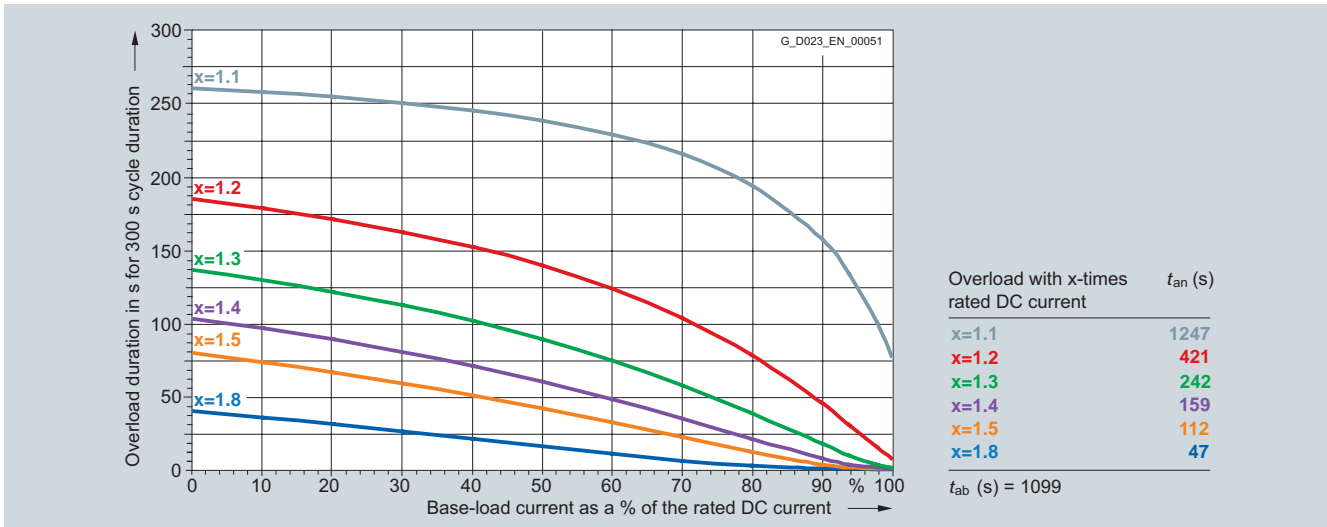

6RA8095-4GS22-0AA0 2 000 A/two-quadrant operation 575 V, 6RA8095-4GV62-0AA0 2 000 A/four-quadrant operation 575 V

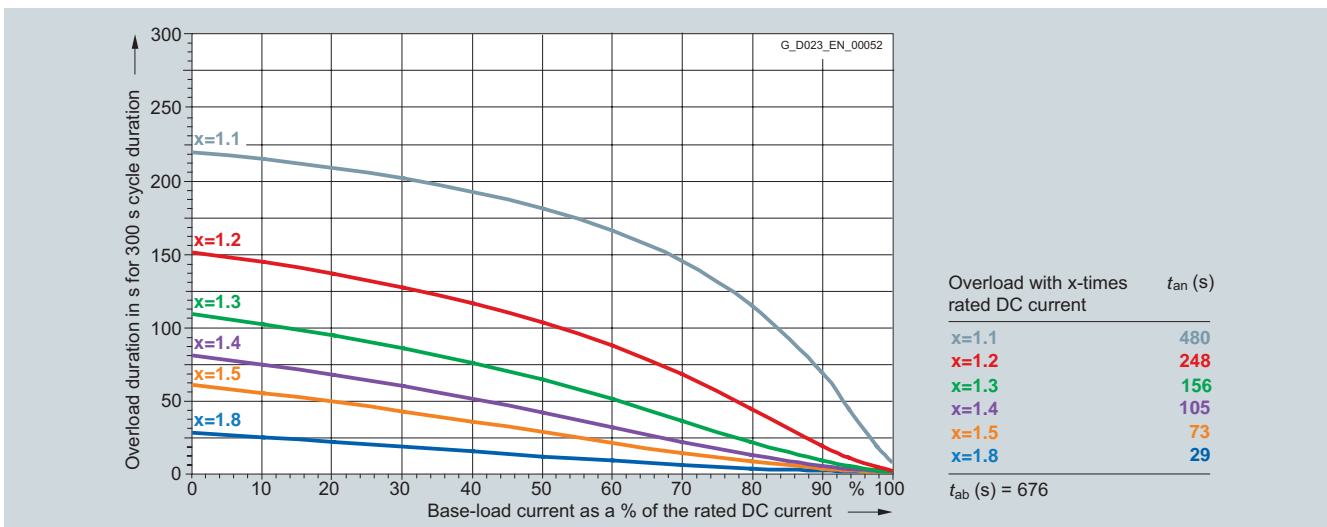

6RA8095-4KS22-0AA0 2 000 A/two-quadrant operation 690 V, 6RA8095-4KV62-0AA0 2 000 A/four-quadrant operation 690 V

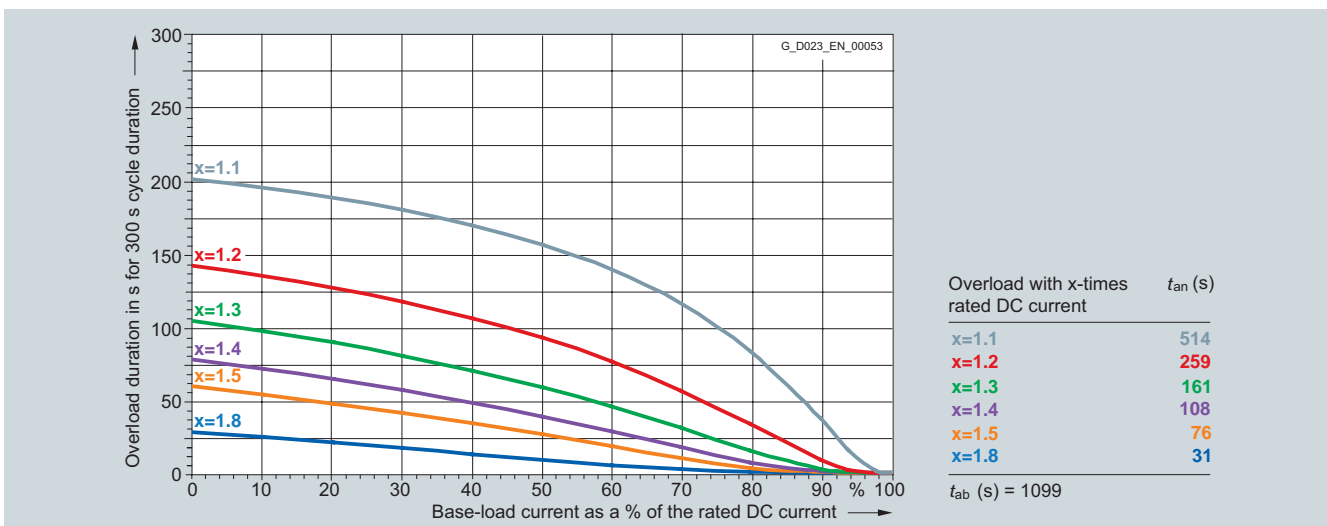

6RA8095-4LS22-0AA0 1 900 A/two-quadrant operation 830 V, 6RA8095-4LV62-0AA0 1 900 A/four-quadrant operation 830 V

SINAMICS DCM

Engineering information

Dynamic overload capability

Overview (continued)

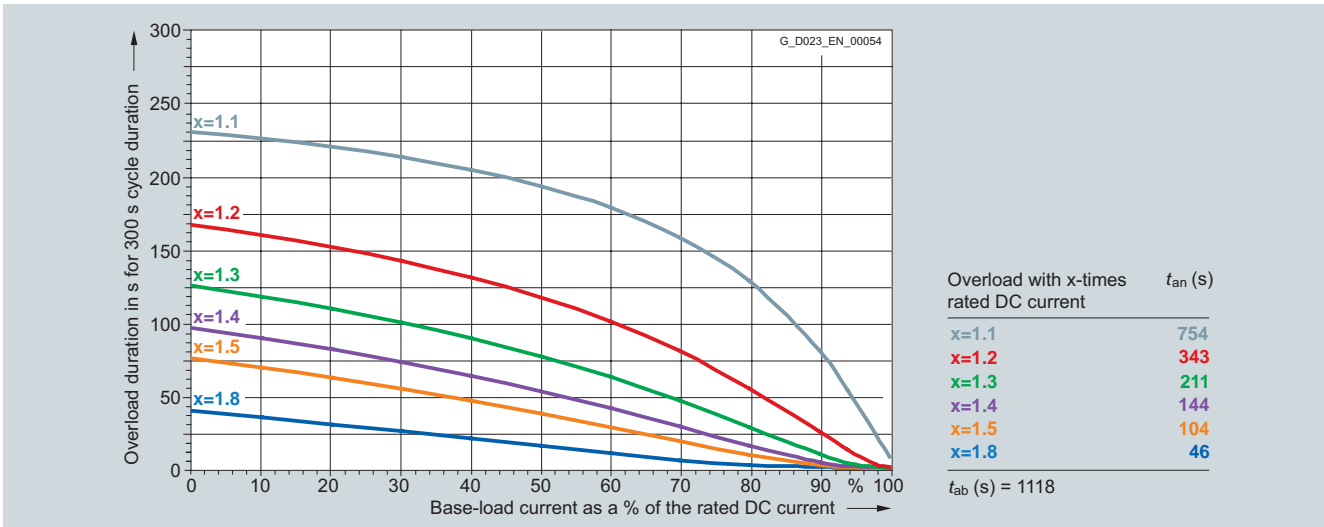

6RA8096-4GS22-0AA0 2 200 A/two-quadrant operation 575 V, 6RA8096-4GV62-0AA0 2 200 A/four-quadrant operation 575 V

5

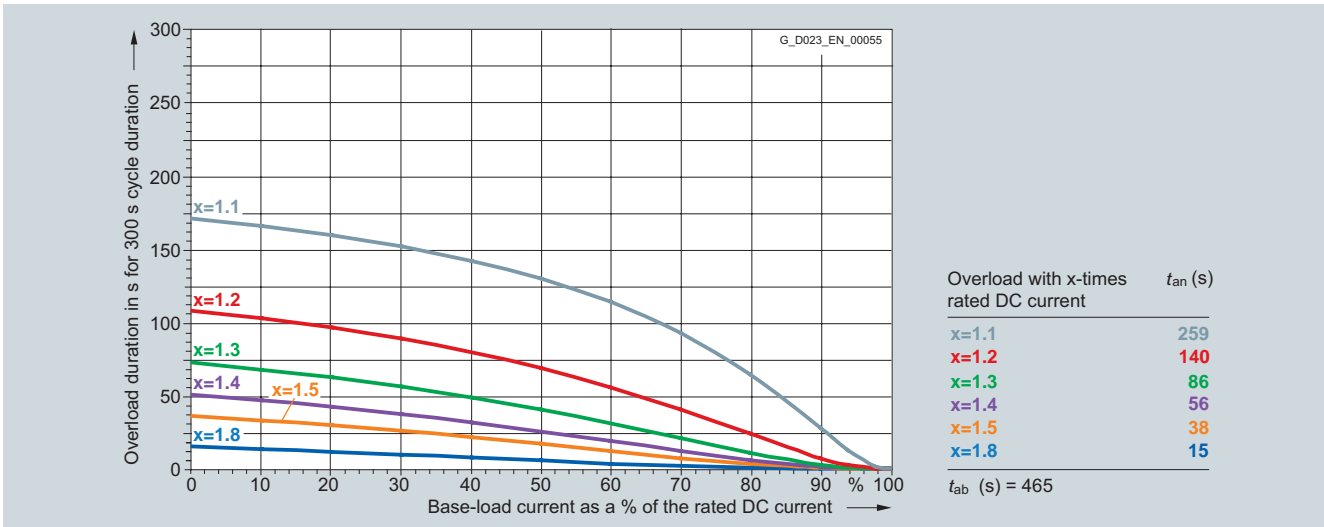

6RA8096-4MS22-0AA0 2 200 A/two-quadrant operation 950 V, 6RA8096-4MV62-0AA0 2 200 A/four-quadrant operation 950 V

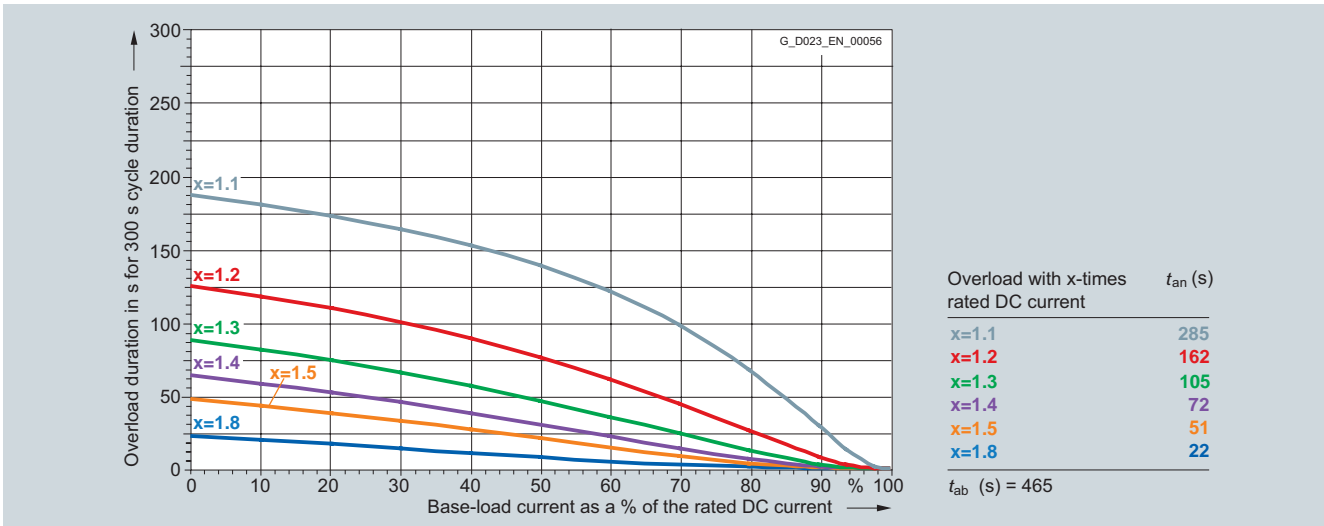

6RA8097-4GS22-0AA0 2 800 A/two-quadrant operation 575 V, 6RA8097-4GV62-0AA0 2 800 A/four-quadrant operation 575 V

Overview (continued)

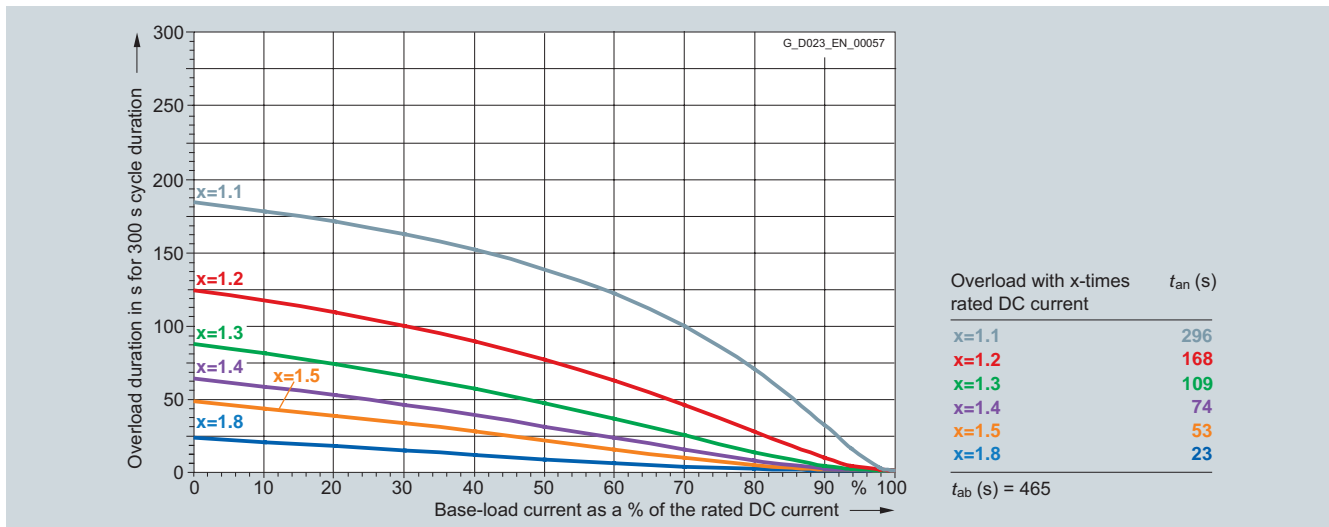

6RA8097-4KS22-0AA0 2 600 A/two-quadrant operation 690 V, 6RA8097-4KV62-0AA0 2 600 A/four-quadrant operation 690 V

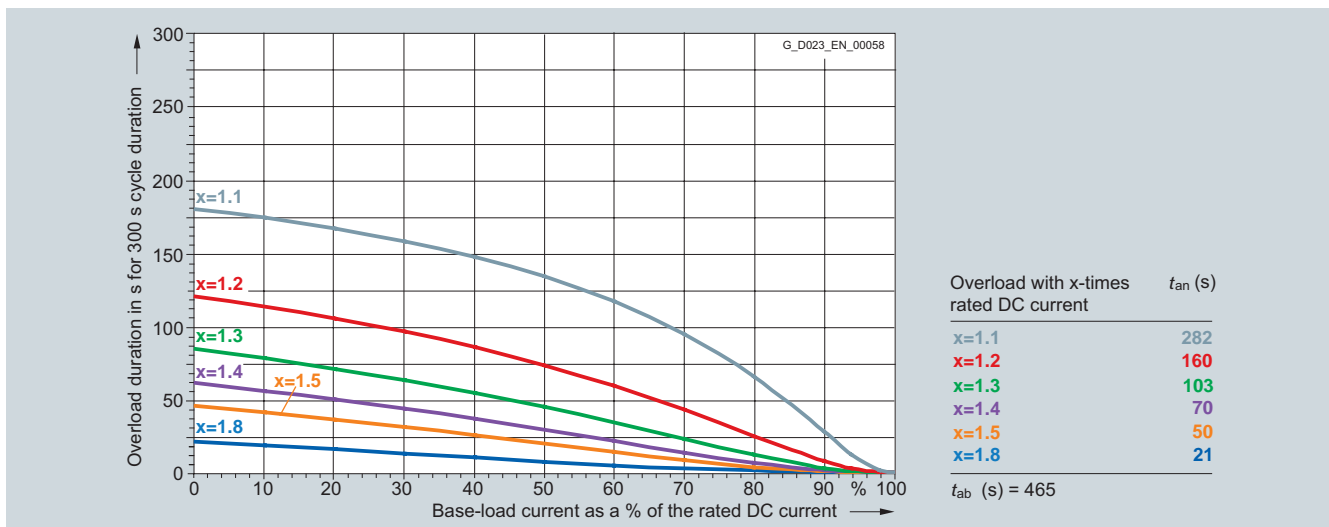

6RA8098-4DS22-0AA0 3 000 A/two-quadrant operation 400 V, 6RA8098-4DV62-0AA0 3 000 A/four-quadrant operation 400 V

Load classes

In order to be able to adapt the SINAMICS DC MASTER as simply as possible to the load profile of the driven machine, in addition to the individual dimensioning using the limiting characteristics of the dynamic overload capability, these can also be dimensioned using pre-selected load cycles that are simple to parameterize.

Note:

SINAMICS DC MASTER does not monitor whether the load class – set using parameters – is maintained. If the power section permits it, the unit can operate for overload durations in excess of those defined by the load class. This means that the driven machine of the mechanical system is not protected against overload!

The overload duration that is actually permitted for the power section in question is always longer than the duration defined by the load class. SINAMICS DC MASTER monitors whether the overload duration that is actually permitted for the power section is being maintained.

SINAMICS DCM

Engineering information

Dynamic overload capability

Overview (continued)

Load class (parameter)	Load for the converter	Load cycle
DC I	$I_{DC I}$ continuous (I_{dN})	<p>100 %</p> <p style="text-align: right;">G_D023_XX_00005</p>
DC II	$I_{DC II}$ for 15 min and $1.5 \times I_{DC II}$ for 60 s	<p>60 s 15 min</p> <p>100 % 150 %</p> <p style="text-align: right;">G_D023_XX_00006</p>
DC III	$I_{DC III}$ for 15 min and $1.5 \times I_{DC III}$ for 120 s	<p>120 s 15 min</p> <p>100 % 150 %</p> <p style="text-align: right;">G_D023_XX_00007</p>
DC IV	$I_{DC IV}$ for 15 min and $2 \times I_{DC IV}$ for 10 s	<p>10 s 15 min</p> <p>100 % 200 %</p> <p style="text-align: right;">G_D023_XX_00008</p>
US rating	I_{US} for 15 min and $1.5 \times I_{US}$ for 60 s Note: With this setting, for all unit types, an ambient and/or cooling medium temperature of 45 °C is permissible.	<p>60 s 15 min</p> <p>100 % 150 %</p> <p style="text-align: right;">G_D023_XX_00006</p>

5

Overview (continued)

Duty cycles for two-quadrant operation

Supply voltage V	SINAMICS DC MASTER converter Type	T_U °C	Duty cycles								US rating $T_U = 45\text{ °C}$	
			DC I		DC II		DC III		DC IV		15 min 100 %	60 s 150 %
			Continu- ous A	15 min 100 % A	60 s 150 % A	15 min 100 % A	120 s 150 % A	15 min 100 % A	10 s 200 % A	15 min 100 % A	60 s 150 % A	
400 V 3 AC	6RA8025-6DS22-0AA0	45	60	51.4	77.1	50.2	75.3	46.4	92.8	51.4	77.1	
	6RA8028-6DS22-0AA0	45	90	74.4	111	72.8	109	65.4	130	74.4	111	
	6RA8031-6DS22-0AA0	45	125	106	159	103	155	96.3	192	106	159	
	6RA8075-6DS22-0AA0	40	210	164	247	161	242	136	273	157	236	
	6RA8078-6DS22-0AA0	40	280	226	340	219	328	201	402	215	323	
	6RA8081-6DS22-0AA0	40	400	290	435	282	423	244	488	278	417	
	6RA8085-6DS22-0AA0	40	600	462	693	446	669	413	826	443	665	
	6RA8087-6DS22-0AA0	40	850	652	978	622	933	609	1 219	619	929	
	6RA8091-6DS22-0AA0	40	1 200	884	1 326	857	1 286	768	1 537	842	1 263	
	6RA8093-4DS22-0AA0	40	1 600	1 255	1 883	1 213	1 819	1 139	2 279	1 190	1 785	
	6RA8095-4DS22-0AA0	40	2 000	1 477	2 216	1 435	2 152	1 326	2 653	1 404	2 106	
6RA8098-4DS22-0AA0	40	3 000	2 288	3 432	2 189	3 283	2 164	4 328	2 178	3 267		
480 V 3 AC	6RA8025-6FS22-0AA0	45	60	51.4	77.1	50.2	75.3	46.4	92.8	51.4	77.1	
	6RA8028-6FS22-0AA0	45	90	74.4	111	72.8	109	65.4	130	74.4	111	
	6RA8031-6FS22-0AA0	45	125	106	159	103	155	96.3	192	106	159	
	6RA8075-6FS22-0AA0	40	210	164	247	161	242	136	273	157	236	
	6RA8078-6FS22-0AA0	40	280	226	340	219	328	201	402	215	323	
	6RA8082-6FS22-0AA0	40	450	320	480	311	466	274	548	306	460	
	6RA8085-6FS22-0AA0	40	600	462	693	446	669	413	826	443	665	
	6RA8087-6FS22-0AA0	40	850	652	978	622	933	609	1 219	619	929	
	6RA8091-6FS22-0AA0	40	1 200	884	1 326	857	1 286	768	1 537	842	1 263	
575 V 3 AC	6RA8025-6GS22-0AA0	45	60	51.4	77.1	50.2	75.3	46.4	92.8	51.4	77.1	
	6RA8031-6GS22-0AA0	45	125	106	159	103	155	96.3	192	106	159	
	6RA8075-6GS22-0AA0	40	210	164	247	161	242	136	273	157	236	
	6RA8081-6GS22-0AA0	40	400	290	435	282	423	244	488	278	417	
	6RA8085-6GS22-0AA0	40	600	462	693	446	669	413	826	443	665	
	6RA8087-6GS22-0AA0	40	800	607	911	581	872	559	1 118	578	867	
	6RA8090-6GS22-0AA0	40	1 100	804	1 207	782	1 173	689	1 379	766	1 150	
	6RA8093-4GS22-0AA0	40	1 600	1 255	1 883	1 213	1 819	1 139	2 279	1 190	1 785	
	6RA8095-4GS22-0AA0	40	2 000	1 663	2 494	1 591	2 386	1 568	3 136	1 569	2 354	
	6RA8096-4GS22-0AA0	40	2 200	1 779	2 669	1 699	2 549	1 697	3 394	1 678	2 517	
	6RA8097-4GS22-0AA0	40	2 800	2 136	3 204	2 044	3 066	2 022	4 044	2 024	3 036	
690 V 3 AC	6RA8086-6KS22-0AA0	40	720	553	829	527	791	515	1 031	525	788	
	6RA8090-6KS22-0AA0	40	1 000	737	1 105	715	1 072	639	1 279	702	1 053	
	6RA8093-4KS22-0AA0	40	1 500	1 171	1 757	1 140	1 710	1 036	2 073	1 116	1 674	
	6RA8095-4KS22-0AA0	40	2 000	1 589	2 383	1 522	2 283	1 505	3 011	1 503	2 255	
	6RA8097-4KS22-0AA0	40	2 600	1 992	2 989	1 906	2 859	1 887	3 774	1 876	2 815	
830 V 3 AC	6RA8088-6LS22-0AA0	40	950	700	1 051	679	1 019	607	1 215	667	1 001	
	6RA8093-4LS22-0AA0	40	1 500	1 171	1 757	1 140	1 710	1 036	2 073	1 116	1 674	
	6RA8095-4LS22-0AA0	40	1 900	1 485	2 228	1 421	2 132	1 396	2 793	1 414	2 121	
950 V 3 AC	6RA8096-4MS22-0AA0	40	2 200	1 674	2 511	1 603	2 404	1 570	3 141	1 588	2 382	

SINAMICS DCM

Engineering information

Dynamic overload capability

Overview (continued)

Duty cycles for four-quadrant operation

Supply voltage V	SINAMICS DC MASTER converter Type	T_u °C	Duty cycles								US rating $T_u = 45\text{ °C}$	
			DC I		DC II		DC III		DC IV		15 min 100 %	60 s 150 %
			Continu- ous A	15 min 100 % A	60 s 150 % A	15 min 100 % A	120 s 150 % A	15 min 100 % A	10 s 200 % A	15 min 100 % A	60 s 150 % A	
400 V 3 AC	6RA8013-6DV62-0AA0	45	15	13.9	20.8	13.5	20.2	12.6	25.2	13.9	20.8	
	6RA8018-6DV62-0AA0	45	30	24.9	37.3	24.2	36.3	22.4	44.8	24.9	37.3	
	6RA8025-6DV62-0AA0	45	60	53.1	79.6	51.8	77.7	47.2	94.4	53.1	79.6	
	6RA8028-6DV62-0AA0	45	90	78.2	117	76	114	72.2	144	78.2	117	
	6RA8031-6DV62-0AA0	45	125	106	159	103	155	95.4	190	106	159	
	6RA8075-6DV62-0AA0	40	210	164	247	161	242	136	273	157	236	
	6RA8078-6DV62-0AA0	40	280	226	340	219	328	201	402	215	323	
	6RA8081-6DV62-0AA0	40	400	300	450	292	438	247	494	285	428	
	6RA8085-6DV62-0AA0	40	600	470	706	453	680	410	820	450	675	
	6RA8087-6DV62-0AA0	40	850	658	987	634	951	579	1 159	626	939	
	6RA8091-6DV62-0AA0	40	1 200	884	1 326	857	1 286	768	1 537	842	1 263	
	6RA8093-4DV62-0AA0	40	1 600	1 255	1 883	1 213	1 819	1 139	2 279	1 190	1 785	
	6RA8095-4DV62-0AA0	40	2 000	1 477	2 216	1 435	2 152	1 326	2 653	1 404	2 106	
	6RA8098-4DV62-0AA0	40	3 000	2 288	3 432	2 189	3 283	2 164	4 328	2 178	3 267	
480 V 3 AC	6RA8013-6FV62-0AA0	45	15	13.9	20.8	13.5	20.2	12.6	25.2	13.9	20.8	
	6RA8018-6FV62-0AA0	45	30	24.9	37.3	24.2	36.3	22.4	44.8	24.9	37.3	
	6RA8025-6FV62-0AA0	45	60	53.1	79.6	51.8	77.7	47.2	94.4	53.1	79.6	
	6RA8028-6FV62-0AA0	45	90	78.2	117	76	114	72.2	144	78.2	117	
	6RA8031-6FV62-0AA0	45	125	106	159	103	155	95.4	190	106	159	
	6RA8075-6FV62-0AA0	40	210	164	247	161	242	136	273	157	236	
	6RA8078-6FV62-0AA0	40	280	226	340	219	328	201	402	215	323	
	6RA8082-6FV62-0AA0	40	450	320	480	311	466	274	548	306	460	
	6RA8085-6FV62-0AA0	40	600	470	706	453	680	410	820	450	675	
	6RA8087-6FV62-0AA0	40	850	658	987	634	951	579	1 159	626	939	
	6RA8091-6FV62-0AA0	40	1 200	884	1 326	857	1 286	768	1 537	842	1 263	
	575 V 3 AC	6RA8025-6GV62-0AA0	45	60	53.1	79.6	51.8	77.7	47.2	94.4	53.1	79.6
		6RA8031-6GV62-0AA0	45	125	106	159	103	155	95.4	190	106	159
		6RA8075-6GV62-0AA0	40	210	164	247	161	242	136	273	157	236
6RA8081-6GV62-0AA0		40	400	300	450	292	438	247	494	285	428	
6RA8085-6GV62-0AA0		40	600	470	706	453	680	410	820	450	675	
6RA8087-6GV62-0AA0		40	850	658	987	634	951	579	1 159	626	939	
6RA8090-6GV62-0AA0		40	1 100	804	1 207	782	1 173	689	1 379	766	1 150	
6RA8093-4GV62-0AA0		40	1 600	1 255	1 883	1 213	1 819	1 139	2 279	1 190	1 785	
6RA8095-4GV62-0AA0		40	2 000	1 663	2 494	1 591	2 386	1 568	3 136	1 569	2 354	
6RA8096-4GV62-0AA0		40	2 200	1 779	2 669	1 699	2 549	1 697	3 394	1 678	2 517	
6RA8097-4GV62-0AA0		40	2 800	2 136	3 204	2 044	3 066	2 022	4 044	2 024	3 036	
690 V 3 AC		6RA8086-6KV62-0AA0	40	760	598	898	575	863	532	1 065	569	853
		6RA8090-6KV62-0AA0	40	1 000	737	1 105	715	1 072	639	1 279	702	1 053
		6RA8093-4KV62-0AA0	40	1 500	1 171	1 757	1 140	1 710	1 036	2 073	1 116	1 674
	6RA8095-4KV62-0AA0	40	2 000	1 589	2 383	1 522	2 283	1 505	3 011	1 503	2 255	
	6RA8097-4KV62-0AA0	40	2 600	1 992	2 989	1 906	2 859	1 887	3 774	1 876	2 815	
830 V 3 AC	6RA8088-6LV62-0AA0	40	950	700	1 051	679	1 019	607	1 215	667	1 001	
	6RA8093-4LV62-0AA0	40	1 500	1 171	1 757	1 140	1 710	1 036	2 073	1 116	1 674	
	6RA8095-4LV62-0AA0	40	1 900	1 485	2 228	1 421	2 132	1 396	2 793	1 414	2 121	
950 V 3 AC	6RA8096-4MV62-0AA0	40	2 200	1 674	2 511	1 603	2 404	1 570	3 141	1 588	2 382	

Overview

Parallel connection of SINAMICS DC MASTER units

SINAMICS DC MASTER units can be connected in parallel to increase the power rating.

The following secondary conditions must be fulfilled:

The hardware and plug connectors necessary to transmit the firing pulses and to establish the higher-level communication are provided on the CUD.

A maximum of 6 units can be connected in parallel. When connecting several units in parallel, the master unit should be positioned centrally due to the signal runtimes. Maximum cable length of the parallel-connection interface cable between master and slave units at each end of the bus: 15 m.

Identical, separate commutating reactors (u_k min. 2 %) are required for each SINAMICS DC MASTER unit in order to evenly distribute the current. The difference in reactor tolerances determines the current distribution. For operation without derating (current reduction), a tolerance of 5 % or better is recommended.

Only units with the same DC current ratings are permitted to be connected in parallel.

The permissible output current when connecting units in parallel is, when maintaining the secondary conditions:

$$I_{\max} = n \times I_{N(\text{SINAMICS DC MASTER})}$$

n = number of SINAMICS DC MASTER units

Redundant operation (mode “(n+m) operation”)

SINAMICS DC MASTER units can also be used in a redundant configuration as a special operating mode of the parallel connection. In this operating mode, it is possible to maintain operation with the remaining SINAMICS DC MASTER units if one unit fails (e.g. if a fuse fails in the power section). When appropriately configured and interconnected, both the armature circuit as well as the field circuit can be redundantly operated.

SINAMICS DC MASTER units that can still function, continue to operate without any interruption when a unit fails. When configuring the system, it is important to note that in redundant applications, the power rating of only n units (instead of $n+m$ units) must be sufficient.

In the case of a fault, the master functionality is automatically transferred. As a consequence, this operating mode is possible both when the power section of the slave units fails and when the power section of the master unit fails. (MTBF data in redundant operation are available on request.)

Connection schematic of the armature circuit when connecting SINAMICS DC MASTER units in parallel

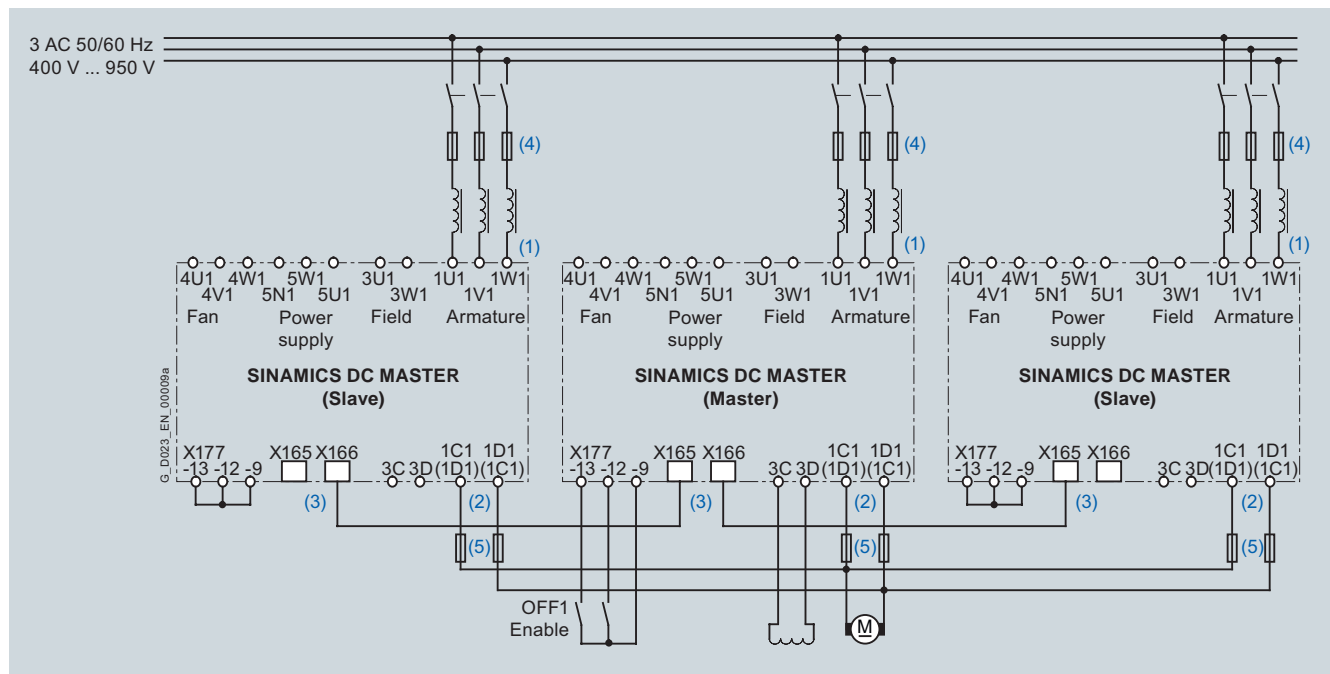

- (1) The same phase sequence is required between 1U1/1V1/1W1.
- (2) The same phase sequence is required between 1C1/1D1.
- (3) The units are connected using (8-pin) shielded patch cables of type UTP CAT5 in acc. with ANSI/EIA/TIA 568, such as those that are used in PC network technology. A standard 5 m long cable can be directly purchased from Siemens (Order No.: 6RY1707-0AA08). $(n-1)$ cables are required to connect n units in parallel. The bus termination must be activated at the units/devices connected at the start of the bus and at the end of the bus.
- (4) These fuses may only be used with units up to 850 A.
- (5) Only for units up to 850 A in four-quadrant operation.

SINAMICS DCM

Engineering information

12-pulse operation

Overview

SINAMICS DC MASTER for 12-pulse operation

For 12-pulse operation, two SINAMICS DC MASTER converters are supplied with voltages displaced by 30 degrees. This configuration reduces the harmonics. Each SINAMICS DC MASTER conducts half of the total current. One of the SINAMICS DC MASTER units is operated with closed-loop speed control, and the second with closed-loop current control. A peer-to-peer connection is used to transfer the current setpoint from the first to the second SINAMICS DC MASTER.

Smoothing reactors are required in the DC circuit for 12-pulse operation.

Calculating the smoothing reactor

- A smoothing reactor is used for each of the two partial converters. The reactor comprises a 2-value reactor; this means that the inductance of the reactor is defined for two current values.
- The reactor is thermally dimensioned according to the rms value of the DC reactor current.

Calculating the required inductance

1. Inductance of the reactor at $0.2 \times I_{dN}$ (L_{D1})

2. Inductance of the reactor for I_{dmax} (L_{D2})

- Inductance for 50 Hz line frequency

$$L_{D1} = 0.296 \times 10^{-3} \times V_{di}/(0.2 \times I_{dN})$$

$$L_{D2} = 0.296 \times 10^{-3} \times V_{di}/(0.33 \times I_{dmax})$$

- Inductance for 60 Hz line frequency

$$L_{D1} = 0.24 \times 10^{-3} \times V_{di}/(0.2 \times I_{dN})$$

$$L_{D2} = 0.24 \times 10^{-3} \times V_{di}/(0.33 \times I_{dmax})$$

L = Inductance in H

I_{dN} half the rated DC current of the DC motor

I_{dmax} half the maximum current of the DC motor

$$V_{di} = 1.35 \times V_N$$

V_N rated line supply voltage

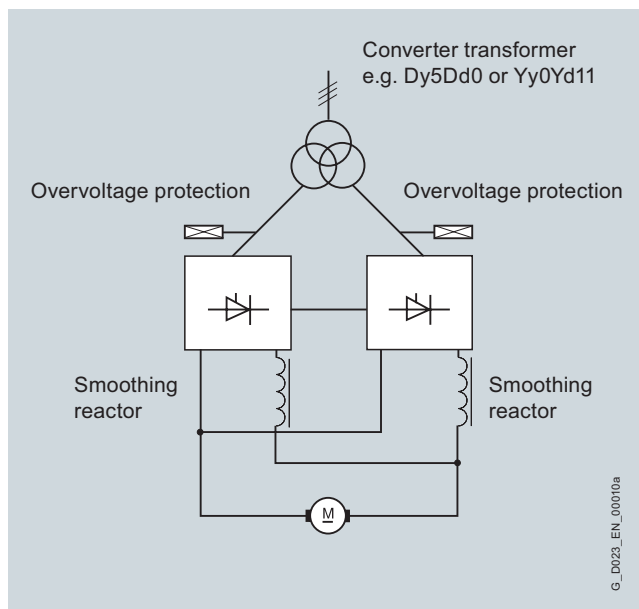

12-pulse operation

Supply of high inductances

Overview

SINAMICS DC MASTER to supply high inductances

To supply high inductances – such as the fields of large DC or synchronous motors or lifting solenoids – the gating unit is changed over to long pulses using the appropriate parameter settings. At high levels of inductance, the long pulses ensure that the thyristors are reliably triggered. In this case, the armature circuit of the units is not used to supply the armature of DC motors, but to supply large field windings.

Note:

An external overvoltage protective circuit must be provided at the DC voltage output of the SINAMICS DC MASTER (e.g. SICROWBAR DC overvoltage protection).

Protection against condensation

Overview

Protection against condensation

SINAMICS DC MASTER are designed in compliance with climate class 3K3 (EN 60721-3-3) without condensation.

When supplied to tropical countries, we recommend that the electrical cabinets are equipped with cabinet heating elements.

Units with coated PCBs are optionally available (option M08); these are insensitive to unfavorable environmental conditions. In order to guarantee safe and reliable operation, under all circumstances, it should be avoided that the units are commissioned with PC boards with moisture condensation.

Overview

Input pulse levels

The evaluation electronics can process encoder signals (symmetrical as well as asymmetrical) up to a maximum differential voltage of 27 V. The encoder type is selected via parameter. The evaluation electronics are electronically adjusted to the encoder signal voltage. With the parameter setting, a sub-division is made into two rated input voltage ranges.

	Rated input voltage range	
	5 V	15 V
Low level	Differential voltage < 0.8 V	Differential voltage < 5 V
High level	Differential voltage > 2 V	Differential voltage > 8 V ¹⁾
Hysteresis	> 0.2 V	> 1 V
Common-mode controllability	± 10 V	± 10 V

If the pulse encoder does not supply any symmetrical encoder signals, it must be grounded with each signal cable twisted in pairs and connected to the negative connections of track 1, track 2, and zero mark.

Maximum frequency that can be evaluated

The maximum frequency of the encoder pulses that can be evaluated is 300 kHz. To ensure that the encoder pulses are evaluated correctly, the minimum edge clearance T_{\min} between two encoder signal edges (track 1, track 2), as listed in the table, must be adhered to.

	Rated input voltage range				
	5 V	15 V	15 V	15 V	15 V
Differential voltage ²⁾	2 V	> 2.5 V	8 V	10 V	> 14 V
T_{\min} ³⁾	630 ns	380 ns	630 ns	430 ns	380 ns

If the pulse encoder is incorrectly matched to the encoder cable, disturbing cable reflections will occur at the receiving end. To ensure that encoder pulses of this type can be evaluated without errors, these reflections need to be damped. The limit values listed in the table below must be maintained in order to prevent the resulting power losses in the evaluation electronics adaptor from being exceeded.

	F_{\max}				
	50 kHz	100 kHz	150 kHz	200 kHz	300 kHz
Differential voltage ⁴⁾	Up to 27 V	Up to 22 V	Up to 18 V	Up to 16 V	Up to 14 V

Cable, cable length, shield connection

The encoder cable capacitance must be recharged at each encoder edge change. The rms value of this current is proportional to the cable length and pulse frequency, and must not exceed the current permitted by the encoder manufacturer. A suitable cable that meets the recommendations of the encoder manufacturer must be used, and the maximum cable length must not be exceeded.

Generally speaking, a twisted cable pair with a single pair shield is sufficient for each track. This reduces crosstalk between the cables. Shielding all the pairs provides protection against interference pulses. The shield should be connected to the SINAMICS DC MASTER shield bar through a large surface area.

¹⁾ Restriction: See "Maximum frequency that can be evaluated"

²⁾ Differential voltage at the terminals of the evaluation electronics

³⁾ The phase error L_G (deviation of 90°), caused by the encoder and cable and which may occur, can be calculated from T_{\min} :

$$L_G = + (90^\circ - f_p \times T_{\min} \times 360^\circ \times 10^{-6})$$

$$L_G \text{ Phase error in } ^\circ$$

$$f_p \text{ Pulse frequency in kHz}$$

$$T_{\min} \text{ Minimum edge clearance in ns}$$

⁴⁾ Differential voltage of the encoder pulses without load (approximate encoder power supply voltage)

SINAMICS DCM

Engineering information

Notes for EMC-compliant drive installation

Overview

Notes for EMC-compliant installation

These installation instructions do not claim to contain all details and versions of units, or to take into account all conceivable operational cases and applications.

Contact partners of the Siemens regional offices are available for additional information or for specific problems, that have not been handled in sufficient detail for your particular application.

The contents of these installation instructions neither form part of nor modify any prior or existing contract, agreement, or legal relationship. The particular contract of sale represents the overall obligations of SIEMENS AG. The warranty specified in the contract between the parties is the only warranty accepted by the SIEMENS AG. Any statements contained in these installation instructions neither create new warranty conditions nor modify the existing warranty conditions.

Basic information about EMC

What is EMC?

EMC stands for "ElectroMagnetic Compatibility" and describes the capability of a device to function satisfactorily in an electromagnetic environment without itself causing interference unacceptable for other devices in the environment. Therefore, the various units should not mutually interfere with one another.

Within the context of the EMC Directive, the SINAMICS DC MASTER units described in this document are not "units" at all, but are instead "components" that are intended to be installed in an overall system or overall plant. For reasons of clarity, however, the generic term "units" is used in many cases.

Interference emissions and interference immunity

EMC is dependent upon two properties demonstrated by the units involved in the system: interference emissions and interference immunity. Electrical units can be sources of interference (senders) and/or potentially susceptible equipment (receivers).

Electromagnetic compatibility is ensured when the existing sources of interference do not impair the function of potentially susceptible equipment.

A unit may even be a source of interference and potentially susceptible equipment at the same time: For example, the power section of a converter unit should be viewed as a source of interference and the control unit as potentially susceptible equipment.

Product standard EN 61800-3

The EMC requirements for "Variable-speed drive systems" are described in the product standard EN 61800-3. A variable-speed drive system (or Power Drive System PDS) consists of the drive converter and the electric motor including cables. The driven machine is not part of the drive system.

EN 61800-3 defines different limit values depending on the location of the drive system, referred to as the first and second environments.

Residential buildings or locations at which the drive system is directly connected to a public low-voltage supply without intermediate transformer are defined as the **first environment**.

The term **second environment** refers to all locations outside residential areas. These are basically industrial areas which are supplied from the medium-voltage line supply via their own transformers.

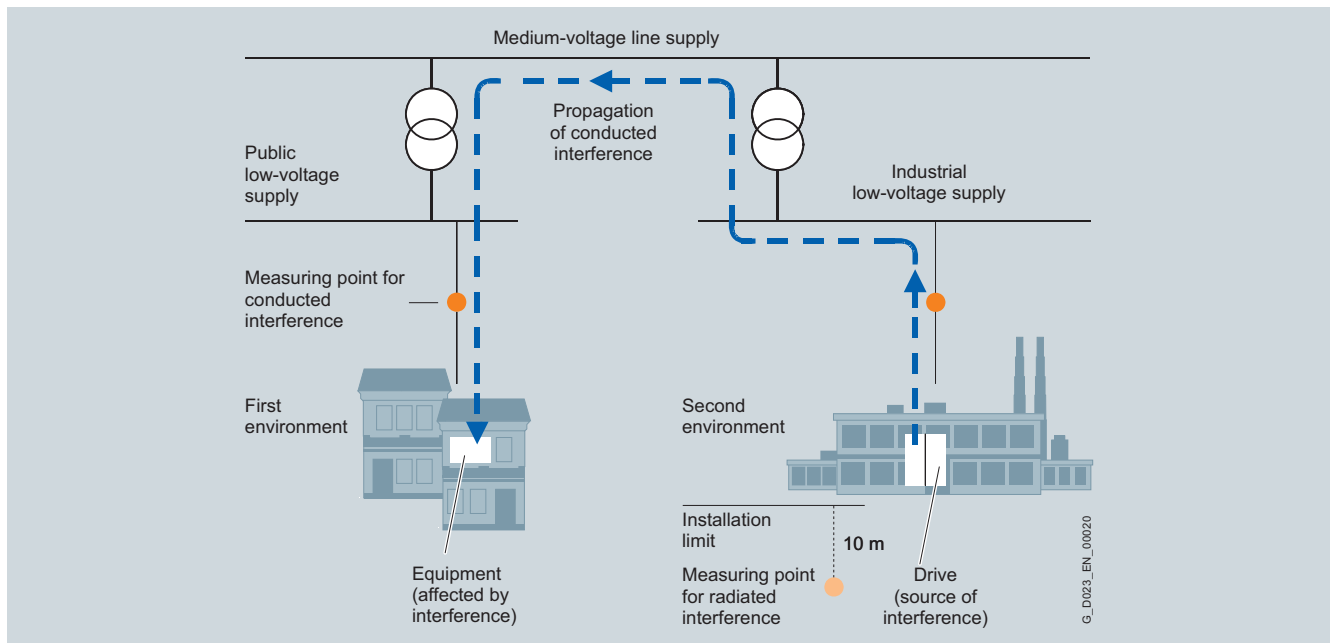

Definition of the first and second environments

Overview (continued)

Four different categories are defined in EN 61800-3 Ed.2 depending on the location and the power of the drive:

Category C1: Drive systems for rated voltages < 1 000 V for unlimited use in the first environment.

Category C2: Stationary drive systems for rated voltages < 1 000 V for use in the second environment. Use in the first environment is possible if the drive system is marketed and installed by qualified personnel. The warning information and installation instructions supplied by the manufacturer must be observed.

Category C3: Drive systems for rated voltages < 1 000 V for exclusive use in the second environment.

Category C4: Drive systems for rated voltages \geq 1 000 V or for rated currents \geq 400 A for use in complex systems in the second environment.

The following diagram shows how the four categories are assigned to the first and second environments:

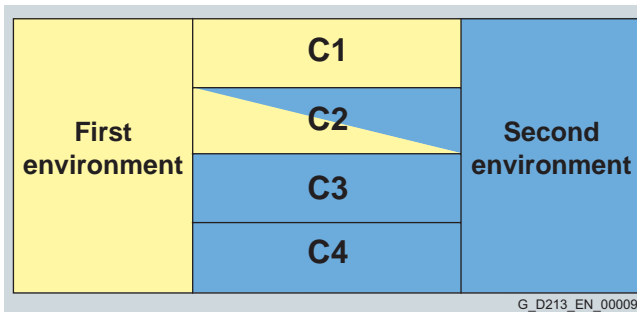

Definition of categories C1 to C4

SINAMICS DC MASTER units are nearly always used in the second environment (Categories C3 and C4).

Radio interference suppression filters and commutating reactors are required whenever they are to be used in Category C2.

SINAMICS DC MASTER units conform to the interference immunity requirements defined in EN 61800-3 for the second environment, and thus also to the lower requirements in the first environment.

Standard EN 55011

Some situations require compliance with standard EN 55011. This defines limit values for interference emissions in industrial and residential environments. The values that are measured are conducted interference at the line supply connection as interference voltage, and electromagnetically radiated interference as radio interference, under standardized conditions.

The standard defines limit values "A1" and "B1" which, for interference voltage, apply to the 150 kHz – 30 MHz range and, for radio interference, the 30 MHz – 2 GHz range. Since SINAMICS DC MASTER converter units are used in industrial applications, they are subject to the limit value "A1". In order to achieve limit value "A1", the SINAMICS DC MASTER units must be provided with external radio interference suppression filters and commutating reactors.

SINAMICS DC MASTER, industrial applications

Industrial applications demand that units demonstrate an extremely high level of interference immunity, but by contrast place very low requirements on them in terms of interference emission levels.

SINAMICS DC MASTER converter units are components of an electrical drive, such as contactors and switches. Qualified personnel must integrate them into a drive system which, as an absolute minimum, consists of the converter unit, motor cables, and motor. Commutating reactors and fuses are also required in

most cases. Therefore, whether or not a limit value is adhered to is determined by the components being installed correctly. Limiting interference emission levels in line with limit value "A1" requires not only the converter unit itself, but also the radio interference suppression filter assigned to it and the commutating reactor, at the very least. Without a radio interference suppression filter, the interference emission level of SINAMICS DC MASTER converter units exceeds limit value "A1" of EN 55011.

If the drive forms part of a plant or system, it does not initially need to fulfill any interference emission requirements. However, EMC legislation does stipulate that the plant or system as a whole must be electromagnetically compatible with its environment.

If all the control components in the plant or system (such as PLCs) demonstrate a level of interference immunity that is suitable for industrial applications, then it is not necessary for every drive to adhere to limit value "A1".

Non-grounded line supplies

Non-grounded line supplies (IT line supplies) are used in some branches of industry in order to increase the availability of the plant. In the event of a ground fault, no fault current flows and the plant can continue with production. However, in conjunction with radio interference suppression filters, in the case of a fault, a fault current flows, which can cause the drives to shut down or possibly even destroy the radio interference suppression filter. This is the reason that the product standard does not define any limit values for these types of line supplies. From an economics perspective, any necessary EMC conformance measures should be taken on the grounded primary side of the supply transformer.

EMC planning

If two units are not electromagnetically compatible, you can reduce the interference emission level of the source of interference or increase the interference immunity of the potentially susceptible equipment.

Sources of interference are generally power electronics units with high power consumption. Reducing their interference emission levels requires complex filters. Potentially susceptible equipment usually refers to controlgear and sensors, including their evaluation circuit. Lower costs are involved with increasing the interference immunity of units with lower power ratings. This means, that from an economics perspective, increasing the interference immunity is generally a more favorable option for industrial applications than reducing the interference emission level. For example, to maintain limit value class A1 of EN 55011, the radio interference voltage at the line supply connection point between 150 and 500 kHz can be a maximum of 79 dB (μ V) and between 500 kHz and 30 MHz, a maximum of 73 dB (μ V) (9 or 4.5 mV).

In industrial applications, EMC between units should be based on a carefully-balanced combination of the interference emission and interference immunity levels.

The most cost-effective measure that can be put in place to achieve EMC conformance is to physically separate sources of interference and potentially susceptible equipment – provided that you have taken this option into account during the planning stage of your machine/plant. In the first instance, it is necessary to determine whether each unit used is a potential source of interference or potentially susceptible equipment. Within this context, converter units and contactors, for example, can be counted as sources of interference. While examples of potentially susceptible equipment include PLCs, encoders and sensors.

The components in the control cabinet (sources of interference and potentially susceptible equipment) must be physically separated, by means of partition plates if necessary, or by installing them in metal enclosures.

Overview (continued)

EMC-compliant drive installation (installation instructions)

General information

Not only are drives operated in a wide variety of environments, but the electrical components used (controls and switched mode power supplies, and so on) can also differ widely with respect to interference immunity and interference emission levels, meaning that all installation guidelines of any kind can offer is a practical compromise. This is the reason that it is possible to deviate from the EMC rules on a case-for-case basis provided that individual measures are tested.

In order to ensure electromagnetic compatibility (EMC) in your control cabinets in rugged electrical environments and adhere to the standards required by the relevant legislating body, the EMC rules listed below should be followed during the construction and design stages.

Rules 1 to 10 are generally valid. Rules 11 to 15 must be followed in order to fulfill interference emission standards.

Rules for EMC-compliant installation

Rule 1

All metal parts of the control cabinet are connected with one another through a large surface area with a good electrical connection (not paint on paint!). If required, contact or serrated washers should be used. The cabinet door must be connected to the cabinet using the shortest possible grounding straps (at the top, center, and bottom).

Rule 2

Contactors, relays, solenoid valves, electromechanical operating hours counters, etc., in the cabinet and – where applicable – in neighboring cabinets – must be provided with quenching combination, e.g. RC elements, varistors, and diodes. The protective circuit must be directly connected to the particular coil.

Rule 3

Signal cables ¹⁾ if at all possible, should only be routed at just one level in the cabinet.

Rule 4

Unshielded cables in the same circuit (outgoing/incoming conductors) must be twisted wherever possible, or the area between them minimized, to prevent the unnecessary formation of frame antennae.

Rule 5

Connect spare wires at both ends to the cabinet ground (ground ²⁾). This achieves an additional shielding effect.

Rule 6

Avoid unnecessary cable lengths. This keeps coupling capacitances and inductances low.

Rule 7

Crosstalk is generally reduced, if cables are routed close to the control cabinet ground. Therefore, do not route cables freely around the cabinet, but route them as close as possible to the cabinet enclosure or to the mounting plates. This also applies to spare cables.

Rule 8

Signal and power cables must be physically separated (to prevent coupling paths!). A minimum distance of 20 cm must be observed.

If it is not possible to physically separate the encoder and motor cables, the encoder cable must be decoupled either using a partition or by routing it in a metal conduit. The partition or metal conduit must be grounded at several points.

Rule 9

Ground the shields of digital signal cables at both ends (source and destination), ensuring maximum contact area and good conductivity. In the event of poor equipotential bonding between the shield connections, run an additional equipotential bonding conductor with a cross-section of at least 10 mm² parallel to the shield for the purpose of reducing the shield current. Generally speaking, the shields may also be connected to the cabinet enclosure (ground) at several points. The shields can be connected several times even outside the control cabinet.

Foil-type shields should be avoided, as they are at least 5 times less effective than braided shields.

Rule 10

Shields for analog signal cables may be connected to ground at both ends if the equipotential bonding is good (this must be done through a large surface area with good conductivity!). It can be assumed that equipotential bonding is good if all of the metal parts are interconnected with one another through a good electrical connection and the electronics components are supplied from a single source.

Connecting shields at one end prevents low-frequency, capacitive interference from being coupled in (e.g. 50 Hz hum). In this case, the shield should be connected in the control cabinet; whereby the shield can also be connected using a separate wire.

Rule 11

Ensure that the radio interference suppression filter is located close to the suspected source of interference. The filter must be attached to the cabinet enclosure, mounting plate, etc., through a large surface area. Incoming and outgoing cables must be physically separated.

Rule 12

Radio interference suppression filters must be used in order to conform to limit value class A1. Additional loads must be connected upstream of the filter (line side).

The control used and the manner in which the rest of the control cabinet is wired will determine whether an additional line filter needs to be installed.

Rule 13

A commutating reactor must be included in the field circuit for controlled field power supplies.

Rule 14

A commutating reactor must be included in the armature circuit of the converter.

Rule 15

The motor cables do not have to be shielded. There must be a clearance of at least 20 cm between the line supply feeder cable and the motor cables (field, armature). If necessary, a separating metal partition should be used.

The cabinet design shown in the following diagram is intended to help the user become familiar with EMC-critical parts. This example does not claim to show all possible cabinet components or design options.

Additional diagrams show details that are not immediately clear in the overview diagram and which may also have an effect on the resistance to interference/interference emission levels of the cabinet as well as different shield connection techniques.

¹⁾ Signal cables are defined as:
Digital signal cable:
Cables for pulse encoders,
serial interfaces, e.g. PROFIBUS-DP or
analog signal cable, e.g. ± 10 V setpoint cable.

²⁾ Generally speaking, "ground" refers to all metallic conductive parts that can be connected to a protective conductor, such as the cabinet enclosure, motor enclosure, or foundation ground etc..

Overview (continued)

Arrangement of radio interference suppression filters and commutating reactors

Another section shows how the radio interference suppression filters and commutating reactors are arranged in a SINAMICS DC MASTER. The order in which the reactors and filters are installed must be adhered to. The filter cables on the line side and unit side must be physically separated.

For information on selecting fuses for semiconductor protection, please refer to the section titled "Line fuses".

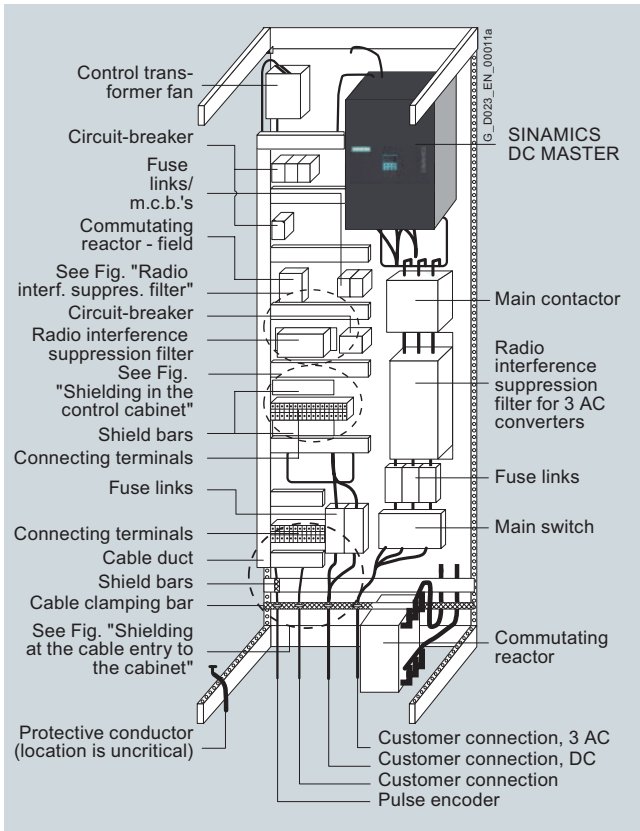

Example of a cabinet design with a SINAMICS DC MASTER of up to 850 A

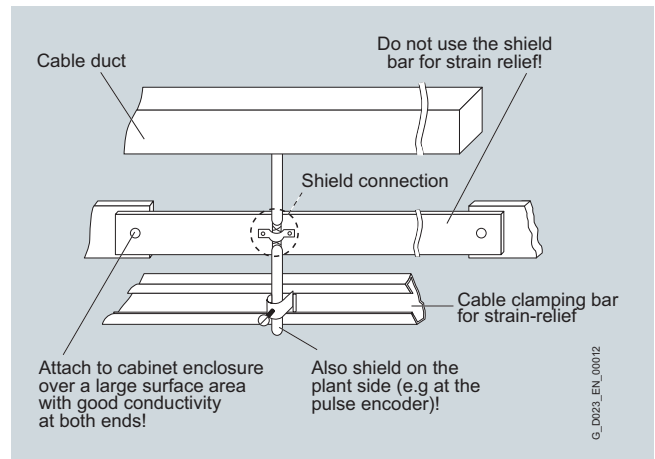

Shielding at the cable entry to the cabinet

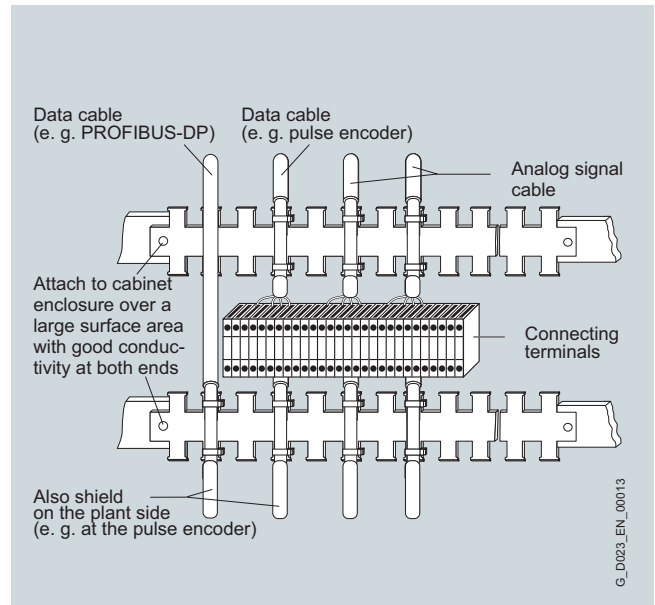

Shielding in the control cabinet

SINAMICS DCM

Engineering information

Notes for EMC-compliant drive installation

Overview (continued)

Radio interference suppression filter for the SINAMICS DC MASTER field power section

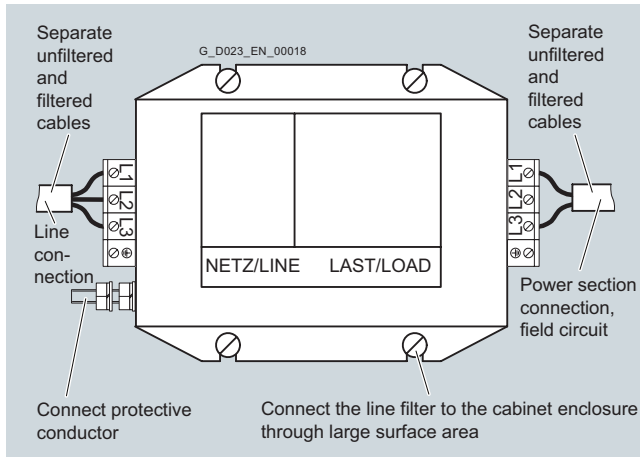

Radio interference suppression filter

Shield connection

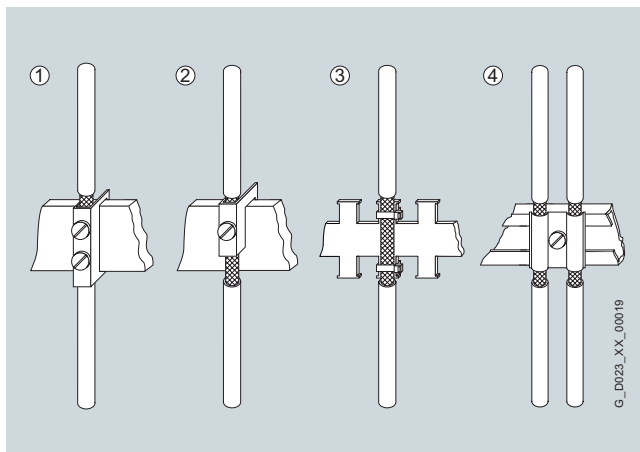

Shield connection

- ① Connecting terminal on a copper bar, max. cable diameter 15 mm
- ② Bar-mounting terminal on a copper bar, max. cable diameter 10 mm
- ③ Metal tube or cable tie on a bare-metal comb-type/toothed bar
- ④ Clamp with metal backing plate on a cable support rail

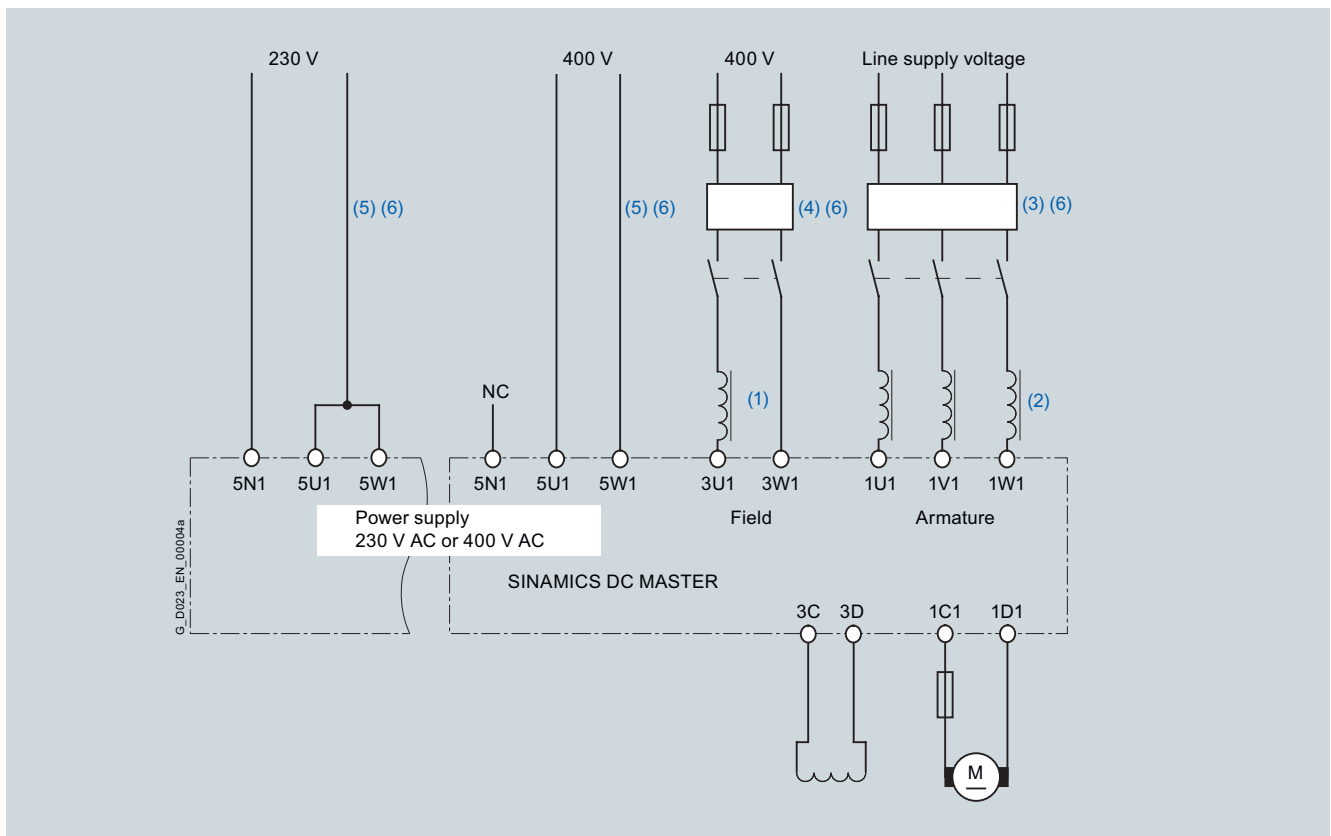
Overview (continued)Arrangement of the components for converter units

Arrangement of reactors and radio interference suppression filters

- (1) The commutating reactor in the field circuit is dimensioned for the rated motor field current.
- (2) The commutating reactor in the armature circuit is dimensioned for the rated motor armature current. The line current is 0.82 times the DC current.
- (3) The radio interference suppression filter for the armature circuit is dimensioned for the rated motor armature current. The line current is 0.82 times the DC current.
- (4) The radio interference suppression filter for the field circuit is dimensioned for the rated motor field current.
- (5) Radio interference suppression filters are not required for the electronics power supply alone. Current consumption at 400 V 1 A, at 230 V 2 A.
- (6) If the power supply voltages for the armature circuit, field circuit and electronics power supply are the same, then the voltage for the field and electronics power supply can also be taken after the radio interference suppression filter for the armature circuit.

SINAMICS DCM

Engineering information

Harmonics

Overview

Line-side harmonics produced by converter units in a fully-controlled three-phase bridge circuit B6C and (B6)A(B6)C

The majority of converter units for medium-power applications have a fully-controlled three-phase bridge circuit. Below is an example of the harmonics that can be found in a typical system configuration for two firing angles ($\alpha = 20^\circ$ and $\alpha = 60^\circ$).

The values have been taken from a previous publication, "Oberschwingungen im netzseitigen Strom sechspulsiger netzgeführter Stromrichter (Harmonics in the Line-Side Current of Six-Pulse, Line-Commutated Converters)" by H. Arremann and G. Möltgen, Siemens Research and Development Division, Volume 7 (1978) No. 2, © Springer-Verlag 1978.

In addition, the formulas are specified which, depending on the actual operating data in use, line supply voltage (no-load voltage V_{V0}), line frequency f_N and DC current I_d , can be used to calculate the short-circuit power S_K and armature inductance L_a for the motor to which the specified harmonics spectrum applies.

If the actual line short-circuit power and/or actual armature inductance deviate from the values calculated in this way, then they will need to be calculated on a case-by-case basis.

The harmonics spectrum shown below is obtained if the values for the short-circuit power S_K at the point where the unit is connected and the armature inductance L_a of the motor, calculated using the following formulas, match the actual values of the plant or system. If the values do not match, the harmonics will have to be separately calculated.

v	I_v/I_1	
	at $\alpha = 20^\circ$ fundamental factor $g = 0.962$	at $\alpha = 60^\circ$ fundamental factor $g = 0.953$
5	0.235	0.283
7	0.100	0.050
11	0.083	0.089
13	0.056	0.038
17	0.046	0.050
19	0.035	0.029
23	0.028	0.034
25	0.024	0.023
29	0.018	0.026
31	0.016	0.019
35	0.011	0.020
37	0.010	0.016
41	0.006	0.016
43	0.006	0.013
47	0.003	0.013
49	0.003	0.011

The fundamental component of current I_1 as a reference variable is calculated using the following formula:

$$I_1 = g \times 0.817 \times I_d$$

I_d DC current of the operating point being investigated
 g Basic fundamental content

The harmonics currents calculated according to the table only apply for:

a) Short-circuit power S_K at the point where the converter unit is connected

$$S_K = V_{V0}^2 / X_N \text{ (VA)}$$

where

$$X_N = X_K - X_D = 0.03536 \times V_{V0} / I_d - 2\pi \times f_N \times L_D \text{ (}\Omega\text{)}$$

V_{V0} No-load voltage at the point where the converter unit is connected in V

I_d DC current of the operating point being investigated in A

f_N Line frequency in Hz

L_D Inductance of the commutating reactor being used in H

b) Armature inductance L_a

$$L_a = 0.0488 \times V_{V0} / (f_N \times I_d) \text{ (H)}$$

If the actual values for the short-circuit power S_K and/or armature inductance L_a deviate from the values calculated using the formulas above, a separate calculation will need to be made.

Example:

Let us assume a drive with the following data:

$$V_{V0} = 400 \text{ V}$$

$$I_d = 150 \text{ A}$$

$$f_N = 50 \text{ Hz}$$

$$L_D = 0.169 \text{ mH (4EU2421-7AA10) with } l_{LN} = 125 \text{ A}$$

where

$$X_N = 0.03536 \times 400 / 150 - 2\pi \times 0.169 \times 10^{-3} = 0.0412 \Omega$$

The following short-circuit power of the line supply required at the point where the converter is connected:

$$S_K = 400^2 / 0.0412 = 3.88 \text{ MVA}$$

and the following armature inductance of the motor required:

$$L_a = 0.0488 \times 400 / (50 \times 150) = 2.0 \text{ mH}$$

The harmonics currents I_v (with $I_1 = g \times 0.817 \times I_d$ for firing angles $\alpha = 20^\circ$ and $\alpha = 60^\circ$) that can be taken from the tables, only apply for the values S_K and L_a that have been calculated in this way. If the actual values deviate from these, a separate calculation will have to be made.

For the purpose of dimensioning filters and compensation equipment with reactors, it is only possible to draw on the information provided by the harmonic values calculated in this way if the calculated values S_K and L_a match the actual drive values. In all other cases, a separate calculation will have to be made (this particularly applies when using compensated motors as they have very low armature inductance levels).

Tools and engineering



6/2	SIZER LD web engineering tool
6/2	Overview
6/3	STARTER commissioning tool
6/3	Overview
6/3	Integration
6/3	Selection and ordering data
6/4	Accessories
6/5	Drive Control Chart (DCC)
6/5	Overview
6/5	Selection and ordering data
6/6	Drive ES engineering software
6/6	Overview
6/6	Application
6/6	Design
6/7	Selection and ordering data
6/8	Options

SINAMICS DCM

Tools and engineering

SIZER LD web engineering tool

Overview

SIZER LD web is used when engineering SINAMICS DC MASTER. It provides supply when selecting and dimensioning the converter, associated options and accessories required for the particular application. SIZER LD web is implemented as web-based application (Internet): <http://www.siemens.com/sizer-ld>.

SIZER LD web supports all of the engineering stages of a converter in just one workflow:

- Enter the motor data, converter data and AC line supply data
- Select the SINAMICS DC MASTER options
- Compile the required documentation and accessories

The SIZER LD web user interface is in German and English.

The engineered drive is saved in a project. From the general idea and the structure, the "Projects" and "Project items" set up in the system correspond to quotations. These are all saved on one server and can be recalled at any time.

Results of the engineering process include:

- Data sheet with the technical data of the engineered converter and where relevant, the accessories
- Dimension drawing of the converter

The results and dimension drawings can be saved or exported to technical quotation documentation.

SIZER LD web requires the following preconditions for its use:

- Internet connection
- Login for SSO (Single-Sign-On) through <http://www.siemens.com/sizer-ld>
- SIZER LD web Version 1 has been designed for Internet Explorer 6 or higher. Mozilla Firefox, Safari (Mac OS) and Opera are also supported from Version 2 and higher.

However, in the future, SINAMICS DC MASTER will not only be able to be engineered in SIZER LD web. It is also possible to engineer the unit in the Industry Mall (<https://mall.automation.siemens.com/>) directly via the configurator list. Almost the whole of the Industry product catalog can be called-up in the Industry Mall – including Configurators for a wide range of products – without having to enter a Login. After logging on to the Mall, users can view the prices and add the products that have been selected into the Mall shopping cart and then enter an order.

Overview

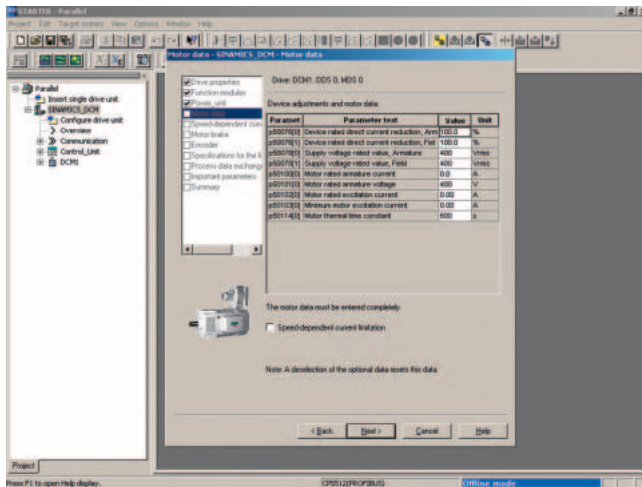

The user-friendly STARTER commissioning tool can be used for:

- Commissioning
- Optimization and
- Diagnostics

This software can either be operated as a stand-alone PC application or can be integrated into the SCOUT engineering system (with SIMOTION) or STEP 7 (with Drive ES Basic). The basic functions and handling are the same in both cases.

In addition to the SINAMICS DC MASTER, the current version of STARTER also supports all of the SINAMICS AC drives – including MICROMASTER 4 and the frequency converters for the SIMATIC ET 200S FC distributed I/O.

SINAMICS DC MASTER is supported from STARTER 4.1.5; it is not possible to use older STARTER versions.

The project wizards can be used to create the drives within the structure of the project tree.

Entry level personnel are interactively supported in a solution-oriented way.

First commissioning is guided by a wizard which makes all of the basic settings in the drive. Therefore, getting a motor up and running is merely a question of setting a few of the drive parameters as part of the drive configuration process.

Examples of individual settings that can be made include:

- Terminals
- Bus interface
- BICO interconnections
- Diagnostics

Experts can quickly access all of the parameters via the Expert List and do not have to navigate through dialogs.

In addition, the following functions are available for optimization purposes:

- Trace (depending on drive)

Diagnostic functions provide information about:

- Control/status words
- Parameter status
- Operating conditions
- Communication states

Performance features

- Easy to use: Only a small number of settings need to be made to successfully commission the drive for the first time: Motor rotates
- Solution-based user navigation simplifies commissioning
- The built-in trace function provides optimum support during commissioning, optimization and troubleshooting

Minimum hardware and software requirements

PG or PC with Pentium III 1 GHz

512 MB RAM (1 GB RAM recommended)

Screen resolution 1 024 × 768 pixels, 16 bit color depth

Free hard disk memory: 2 GB

Windows 2000 SP4, Windows 2003 Server SP1, SP2

Windows XP Professional SP2 or SP3

Windows Vista Business SP1, Windows Vista Ultimate SP1

Microsoft Internet Explorer 6.0

Integration

Communication between the Control Unit of the drive and the programming device (PG) or PC can be established via a serial interface, via PROFIBUS or PROFINET.

The following accessories are available for the particular drive system:

SINAMICS DC MASTER

A PROFIBUS communication module and a connecting cable are required to establish communication between a PG/PC and a CUD.

For example, the **PROFIBUS communication module** CP 5512 (PCMCIA type 2 card + adapter with 9-pin SUB-D socket for connection to PROFIBUS. For MS Windows 2000/XP Professional and PCMCIA 32)
Order No.: 6GK1551-2AA00

and a **connecting cable** between CP 5512 and PROFIBUS
Order No.: 6ES7901-4BD00-0XA0

Selection and ordering data

	Order No.
STARTER commissioning tool for SINAMICS and MICROMASTER	6SL3072-0AA00-0AG0
English/French/German/Italian/Spanish	

STARTER version 4.1 with Service Pack 5, Hotfix 1 is required for SINAMICS DC MASTER.

If new converter units are launched into the market or if the functionality of a converter is extended by new software, then it is not necessary to install new STARTER software. STARTER can be updated by installing an SSP (SINAMICS Support Package). The actual STARTER version as well as updates can be downloaded from the Internet under <http://support.automation.siemens.com/WWW/view/en/10804985/133100> and are provided in the product DVD supplied with each unit.

SINAMICS DCM

Tools and engineering

STARTER commissioning tool

Accessories

Connection

Depending on the version of the Control Unit, the Control Unit (CU) of the drive unit can communicate with the programming device (PG) or PC via a serial interface, PROFIBUS, or Ethernet/PROFINET. The following accessories are available for the particular drive system as listed in the following table.

	Order No.
PROFIBUS communication module CP 5512 PCMCIA type 2 card + adapter with 9-pin SUB-D socket for connection to PROFIBUS. For MS Windows 2000/XP Professional and PCMCIA 32	6GK1551-2AA00
Connecting cable between CP 5512 and PROFIBUS	6ES7901-4BD00-0XA0

Overview

Graphically configuring and expanding the device functionality using the freely available closed-loop control, arithmetic, and logic blocks

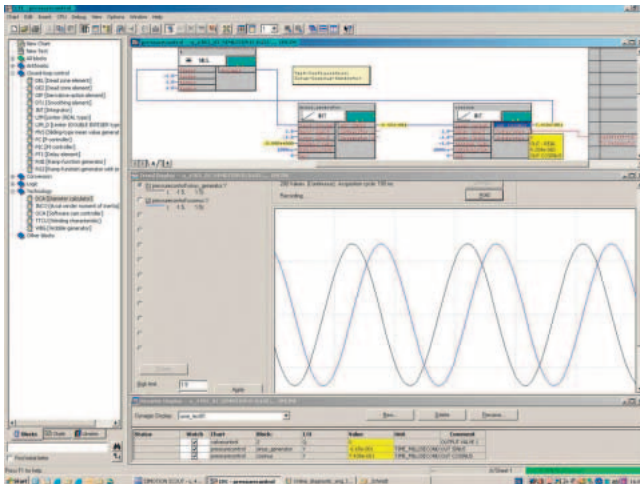
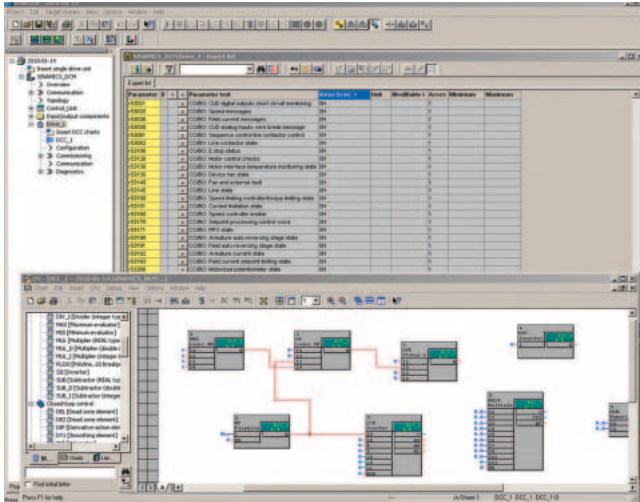

Drive Control Chart (DCC) extends the possibility of very simply configuring technological functions – both for the SIMOTION motion control system as well as for the SINAMICS DC MASTER drive system. For users, this opens up a new dimension regarding the adaptability of the systems mentioned to the specific functions of their machines. DCC has no restrictions with regard to the number of usable functions; this is only limited by the performance capability of the target platform.

The user-friendly DCC editor enables easy graphics-based configuration, allows control loop structures to be clearly represented and provides a high degree of reusability of diagrams that have already been created.

The open-loop and closed-loop control functions are defined by using multi-instance-capable blocks (Drive Control Blocks (DCBs)) from a pre-defined library (DCB library) that are selected and graphically linked with one another by dragging and dropping. Test and diagnostic functions allow the program behavior to be verified and in the case of a fault, the cause identified.

The block library encompasses a large selection of closed-loop, arithmetic and logic blocks, as well as comprehensive open-loop and closed-loop control functions.

For logically combining, evaluating and acquiring binary signals, all commonly used logic functions are available for selection (AND, XOR, on/off delay, RS flipflop, counter, etc.). A wide range of arithmetic functions, such as absolute value generation, dividers and minimum/maximum evaluation are available to monitor and evaluate numerical quantities. In addition to the closed-loop drive control, axial winder functions, closed-loop PI controller, ramp function generator or wobble generator can be configured simply and easily.

Closed-loop control structures can be programmed with almost no restrictions in conjunction with the SIMOTION motion control system. These can then be combined with other program sections to form an overall program.

Further, Drive Control Chart for SINAMICS DC MASTER provides a user-friendly basis to handle drive-related open-loop and closed-loop control tasks directly in the converter. This further extends the possibility of adapting SINAMICS to the particular application. Local data processing in the drive supports the implementation of modular machine concepts and results in an increase in the overall machine performance.

Minimum hardware and software requirements

See the SCOUT or STARTER engineering software, since DCC is installed in addition to this.

Note:

In order to download the DCB library into the drive, it is necessary to use a memory card for the first time (option S01 or option S02 when using a Standard CUD right (option G10) or an Advanced CUD right (option G11)).

Selection and ordering data

DCC comprises the graphic configuring tool (DCC Editor) and the block library (DCB Library).

DCC is installed in addition to the SCOUT or STARTER engineering software.

The necessary engineering license for each PC (floating) for DCC is acquired at the same time the order is placed; additional run time licenses are not required.

DCC can be ordered in two versions: The version for SIMOTION and SINAMICS applications, or the version for SINAMICS applications only.

	Order No.
DCC-SIMOTION-/SINAMICS V2.0 SP1 for SCOUT/STARTER V4.1 SP1 (single-user engineering license, with DCC data carrier) DCC editor + DCB libraries for use on SIMOTION V4.1 SP1 and SINAMICS S120 V2.5 SP1 German/English/French/Italian (SIMOTION) German/English/French/Italian/Spanish (SINAMICS)	6AU1810-1JA20-1XA0
DCC-SINAMICS V2.0 SP1 for STARTER V4.1 SP1 (single-user engineering license, with DCC data carrier) DCC editor + DCB library for use on SINAMICS S120 V2.5 SP1 German/English/French/Italian/Spanish	6AU1810-1HA20-1XA0

SINAMICS DCM

Tools and engineering

Drive ES engineering software

Overview

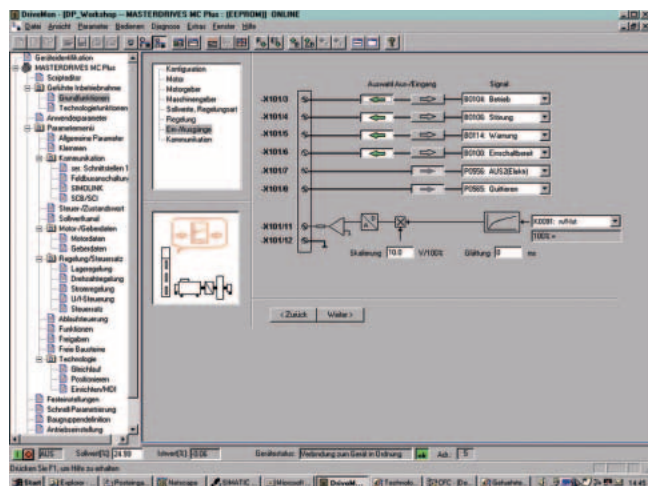

Drive ES is the engineering system used to integrate Siemens drive technology into the SIMATIC automation world easily, efficiently and cost-effectively in terms of communication, configuration and data management.

It is based on the operator interface of the STEP 7 Manager, the essential element when it comes to engineering.

Various software packages are available for selection:

- Drive ES Basic – for entry into the world of Totally Integrated Automation and the capability of routing beyond network boundaries and the use of the SIMATIC teleservice.
- Drive ES SIMATIC – to simply parameterize the STEP 7 communication program instead of programming.
- Drive ES PCS7 – integrates drives with PROFIBUS interface into the SIMATIC PCS7 process control system.

Application

The Drive ES (Drive Engineering Software) engineering software fully integrates drives from Siemens into the world of Totally Integrated Automation.

The table provides a general overview of the Drive ES software packages available for each drive.

Drive	Drive ES Basic V5.4 and higher	Drive ES SIMATIC V5.4 and higher	Drive ES PCS7 V6.0 and higher
SIMOVERT MASTERDRIVES	•	•	•
SIMOREG DC-MASTER	•	•	•
SIMODRIVE 611 universal HRS	•	•	
SIMODRIVE POSMO A/SI/CD/CA	•	•	
MICROMASTER/MIDIMASTER/COMBIMASTER Third generation	•	•	•
MICROMASTER 4 Fourth generation	•	•	•
SINAMICS S110	•	•	
SINAMICS S120	•	•	• 1)
SINAMICS S150	•	•	• 1)
SINAMICS G120	•	•	• 1)
SINAMICS G120D	•	•	• 1)
SINAMICS G130	•	•	• 1)
SINAMICS G150	•	•	• 1)
SINAMICS GL150	•	•	• 1)
SINAMICS GM150	•	•	• 1)
SINAMICS SM150	•	•	• 1)
SINAMICS DC MASTER	• 2)	• 3)	on request

Design

- **Drive ES Basic** is the basic software to parameterize all of the drives online and offline. Using the Drive ES Basic basic software, the automation and the drives can be handled with the SIMATIC Manager software. Drive ES Basic is the starting point for common data archiving for complete projects and for extending the use of routing and the SIMATIC teleservice to drives. Drive ES Basic provides the engineering tools for the new motion control functions, slave-to-slave communication, equidistance mode and clock cycle synchronization with PROFIBUS DP and ensures that drives with PROFINET IO are simply integrated into the SIMATIC environment.

- **Drive ES SIMATIC** requires that STEP 7 has first been installed. It features a SIMATIC function block library, thereby making the programming of the PROFIBUS and/or PROFINET IO interface in the SIMATIC CPU for the drives easy and secure.

There is no need for separate, time-consuming programming of the data exchange between the SIMATIC CPU and the drive.

All Drive ES users need to remember is:

Copy – Modify – Load – Finished.

Customized, fully-developed function blocks are copied from the library into user-specific projects.

- Frequently-used functions are set to run in program format:
- The complete diagnostics memory is automatically read-out of the drive
 - Download complete parameter set automatically from the SIMATIC CPU to the drive, e.g. when a device has to be replaced
 - Automatically download partial parameter sets (e.g. for recipe or product change) from the SIMATIC CPU to the drive
 - Upload the complete parameter assignment or partial parameter sets from the drive to the SIMATIC CPU, that means update.

1) Drive ES PCS7 V6.0 SP2 and higher
 2) Drive ES Basic V5.4 SP5 and higher
 3) Drive ES SIMATIC V5.4 SP3 and higher

Design (continued)

Detailed contents of the Drive ES SIMATIC package:

- **“PROFIBUS DP” communications software** for S7-300 with CPUs with integrated DP interface (DRVDPS7, POSMO function block libraries), S7-400 with CPUs with integrated DP interface or with CP443-5 (DRVDPS7, POSMO function block libraries) and S7-300 with CP342-5 (DRVDPS7C function block library)
- **“USS protocol” communications software** for S7-300 with integrated PtP interfaces or with CP 340/341 and S7-400 with CP 441 (DRVUSSS7 function block library)
- **STEP 7 slave object manager** for the easy configuration of drives as well as for non-cyclic PROFIBUS DP communication with the drives; supports the conversion of DVA_S7 to Drive ES projects (V5.1 and higher)
- **STEP 7 device object manager** for convenient configuration of drives with PROFINET IO interfaces (V5.4 and higher)
- **SETUP program** for installing the software in the STEP 7 environment
- **“PROFINET IO” communications software** for S7-300 with CPUs with integrated PN interface, S7-400 with CPUs with integrated PN interface or with CP (DRVDPS7 function block library, respectively). PROFINET IO and PROFIBUS DP use the same blocks from the DRVDPS7 library, i.e. the blocks are able to serve both buses with a common block (only for V5.4 and higher)
- **Drive ES PCS7** requires that SIMATIC PCS7 (version 5.2 and higher) has first been installed. Drive ES PCS7 provides a function block library with function blocks for the drives and the corresponding faceplates for the operator station which enables the drives to be operated from the PCS7 process control system. From version V6.1 and higher, drives will also be able to be represented in the PCS7 Maintenance Station.

Detailed contents of the Drive ES PCS7 package:

- **Block library for SIMATIC PCS7** Faceplates and control blocks for SIMOVERT MASTERDRIVES VC and MC, as well as MICRO-/MIDIMASTER of the third and fourth generation and SIMOREG DC-MASTER and SINAMICS
- **STEP 7 slave object manager** for convenient configuration of drives and acyclic PROFIBUS DP communications with the drives
- **SETUP program** for installing the software in the PCS7 environment

Selection and ordering data

	Order No.
Drive ES Basic V5.4 SPx ¹⁾ <ul style="list-style-type: none"> • Configuration software for the integration of drives into Totally Integrated Automation • Precondition: STEP 7 V5.3 and higher, SP 3 • Supply as: DVD English/French/German/Italian/Spanish with electronic documentation 	
Floating license, 1 user	6SW1700-5JA00-4AA0
Floating license, (copy license), 60 users	6SW1700-5JA00-4AA1
Update service for single-user license	6SW1700-0JA00-0AB2
Update service for copy license, 60 users	6SW1700-0JA00-1AB2
Upgrade from V5.x to V5.4 SPx ¹⁾	6SW1700-5JA00-4AA4
Drive ES SIMATIC V5.4 SPx ¹⁾ <ul style="list-style-type: none"> • Function block library for SIMATIC for the parameterization of communication with the drives • Precondition: STEP 7, V5.3 and higher, SP 3 • Supply as: CD-ROM English/French/German/Italian/Spanish with electronic documentation 	
Single-user license incl. 1x runtime license	6SW1700-5JC00-4AA0
Runtime license (without data carrier)	6SW1700-5JC00-1AC0
Update service for single-user license	6SW1700-0JC00-0AB2
Upgrade from V5.x to V5.4 SPx ¹⁾	6SW1700-5JC00-4AA4
Drive ES PCS7 V6.1 SPx ¹⁾ <ul style="list-style-type: none"> • Block library for PCS7 for the integration of drives • Precondition: PCS7, V6.1 and higher • Supply as: CD-ROM English/French/German/Italian/Spanish with electronic documentation 	
Single-user license incl. 1x runtime license	6SW1700-6JD00-1AA0
Runtime license (without data carrier)	6SW1700-5JD00-1AC0
Update service for single-user license	6SW1700-0JD00-0AB2
Upgrade from V5.x to V6.1 SPx ¹⁾	6SW1700-6JD00-1AA4
Drive ES PCS7 V7.0 SPx ¹⁾ <ul style="list-style-type: none"> • Block library for PCS7 for the integration of drives • Precondition: PCS7, V7.0 and higher • Supply as: CD-ROM English/French/German/Italian/Spanish with electronic documentation 	
Single-user license, incl. 1x runtime license	6SW1700-7JD00-0AA0
Runtime license (without data carrier)	6SW1700-5JD00-1AC0
Update service for single-user license	6SW1700-0JD00-0AB2
Upgrade from V5.x to V7.0 SPx ¹⁾	6SW1700-7JD00-0AA4

¹⁾ Orders are always automatically supplied with the latest SP.

SINAMICS DCM

Tools and engineering

Drive ES engineering software

Options

Drive ES software update service

A software update service can also be purchased for the Drive ES software. The user will automatically receive the latest software, service packs and full versions for one year after ordering.

The update service can only be ordered in addition to an existing (i.e. previously ordered) full version.

- Period of update service: 1 year

The update service is automatically extended by 1 further year unless canceled up to 6 weeks prior to expiration.

	Order No.
Drive ES Basic	
Update service for single-user license	6SW1700-0JA00-0AB2
Update service for copy license	6SW1700-0JA00-1AB2
Drive ES SIMATIC	
Update service for single-user license	6SW1700-0JC00-0AB2
Drive ES PCS7	
Update service for single-user license	6SW1700-0JD00-0AB2

Services and documentation



7/2	SINAMICS DCM demonstration case
7/2	Overview
7/2	Application
7/2	Function
7/2	Technical specifications
7/2	Selection and ordering data
7/3	Training
7/3	Overview
7/3	<ul style="list-style-type: none"> • Faster and more applicable know-how: Hands-on training from the manufacturer • SITRAIN highlights
7/4	Range of training courses
7/4	Overview
7/4	<ul style="list-style-type: none"> • Commissioning SINAMICS DCM
7/5	Service & Support – Services covering the entire life cycle
7/5	Online Support
7/5	Technical Support
7/5	Technical Consulting
7/5	Engineering Support
7/5	Field Service
7/5	Spare Parts and Repairs
7/5	Optimization and Upgrading
7/6	Knowledge Base on DVD
7/6	Automation Value Card
7/7	Documentation
7/7	Overview
7/7	Selection and ordering data

SINAMICS DCM

Services and documentation

SINAMICS DCM demonstration case

Overview



Demonstration case, opened

The SINAMICS DC MASTER demonstration model is installed ready to be connected-up in a rugged transport case and is immediately ready for operation. It comprises a DC converter 480 V 3 AC, DC 30 A, a 1 kW DC motor as well as numerous options and accessories. The case has two integrated transport wheels and a hinged handle.

Scope of delivery

The following main components are included in the SINAMICS DC MASTER demonstration case, including all of the required wiring, connection and signal cables:

- DC converter 6RA8018-6FV62-0AA0-Z;
Z=G00+G10+G20+S01
G00 = Advanced CUD left
G10 = Standard CUD right
G20 = Communication Board CBE20 left
S01 = Memory card left
- TM31 Terminal Module
- TM15 Terminal Module
- AOP30 Advanced Operator Panel
- Radio interference suppression filter
- Three-phase commutating reactor for the armature circuit
- Single-phase commutating reactor for the field circuit
- DC motor 1 kW, 1 750 rpm
- Pulse encoder OG 60 DN 2040 CI
- Analog tachometer GT 5.05 L/410, $V_0 = 10 \text{ V}/1\ 000 \text{ rpm}$
- Commissioning box for SINAMICS DC MASTER to control analog and digital inputs and outputs

Free function blocks and Drive Control Chart can be used without any restrictions.

The demonstration case is also available without integrated DC motor to operate an externally mounted DC motor. (The rated converter data must be observed.)

Application

- Demonstrating DC drives to customers
- Training Siemens employees and customers
- Test configurations

An automation group using a SIMATIC demonstration case together with one or several SINAMICS DC MASTER demonstration cases can be implemented.

Function

Operation

The converter can be operated from:

- the commissioning box, which is connected to the terminals of the unit or the TM15 and TM31
- the AOP30 operator panel
- the PROFIBUS interface
- the PROFINET interface

A description is provided with the demonstration case. This clearly shows the principle operator panel design and the possible functions of the operator controls.

To use the STARTER commissioning tool users require a programming device or PC. The system requirements are described in section STARTER.

Technical specifications

SINAMICS DCM demonstration case	
Line supply connection	
Supply voltage	400 V 3 AC (+15 %/-20 %)
Rated frequency	45 ... 65 Hz
Connecting cable with 16-A-CECON connector (5UR5076-3), length	approx. 4 m
Line connection fusing required	16 A
Dimensions and weights	
• Width	approx. 680 mm
• Height	approx. 700 mm
• Depth	approx. 430 mm
Weight with integrated DC motor	approx. 70 kg
Weight without motor	approx. 55 kg

Selection and ordering data

SINAMICS DCM demonstration case	
Description	Order No.
With integrated DC motor	6RX1800-0SM00
Without motor	6RX1800-0SV00

The demonstration case with integrated DC motor is also available for rental.

Please contact your regional Siemens sales person.

Overview

Faster and more applicable know-how: Hands-on training from the manufacturer

SITRAIN® – Siemens Training for Automation and Industrial Solutions – provides you with comprehensive support in solving your tasks.

Training by the market leader in automation and plant engineering enables you to make correct decisions with confidence. Especially when it involves the optimum and efficient use of products and plants. You can eliminate deficiencies in existing plants and avoid expensive planning mistakes right from the very start.



First-class know-how which pays off directly: In shorter commissioning times, high-quality end products, faster troubleshooting and reduced downtimes. In other words, higher profits and lower costs.

Achieve more with SITRAIN

- Shorter times for commissioning, maintenance and service
- Optimized production operations
- Reliable engineering and commissioning
- Minimizing plant downtimes
- Flexible plant adaptation to market requirements
- Compliance with quality standards in production
- Increased employee satisfaction and motivation
- Shorter familiarization times following changes in technology and staff

Contact

Visit our Internet site under:

<http://www.siemens.com/sitrain> or let us advise you personally. You can request our latest training catalog from:

SITRAIN Customer Support Germany:

Tel.: +49 (0)1805 / 23 56 11

Fax: +49 (0)1805 / 23 56 12

(0.14 €/min. from German landlines, mobile call charges may differ)

E-Mail: info@sitrain.com

SITRAIN highlights

Top trainers

Our trainers have a wealth of practical and didactic experience. Course developers have direct contact to product development, and directly pass on their knowledge to the trainers.

Practical experience

The practical experience of our trainers enables them to teach theory effectively. But since it is known that all theory is drab, we attach great importance to practical exercises which can comprise up to half of the course time. You can therefore immediately implement your new knowledge in practice. We train you on state-of-the-art equipment that has been designed both from the methodology and didactic perspectives. You feel absolutely certain when trained in this environment.

Wide variety

With a total of about 300 local attendance courses, we train the complete range of products from Siemens Industry as well as interaction of the products in systems.

Customized training

We are never far away. You can find us at more than 50 locations in Germany, and in 62 countries worldwide. You wish to have individual training instead of one of our 300 courses? Our solution: We will provide a program tailored exactly to your personal requirements. Training can be carried out in our Training Centers or at your company.

The right combination: Blended learning

Blended learning is the combination of various training media and sequences. For example, attending a course in a local training center can be optimally supplemented by a teach-yourself program as preparation or follow-up. Spin-off: Lower travel costs and shorter times away from work.



SINAMICS DCM

Services and documentation

Range of training courses

Overview

Commissioning SINAMICS DCM

Description/learning objective

This training course explains how you adapt the parameter settings of the converter to the application and the DC motor. You expand your theoretical knowledge in the form of exercises carried out on special training equipment. After participating in the course, you know the functions of a converter and the interfaces. You are in a position to safely and quickly commission the unit. Through routine fault diagnostics and troubleshooting, you save time and optimize the availability of your plant or system.

Target group

Commissioning engineers, project engineers, service personnel

Preconditions

Basic knowledge of electrical engineering

Content

- Design and function of the SINAMICS DC MASTER converter:
 - Control module CUD
 - Power section
 - Field circuit
 - Interfaces
 - Circuit diagrams

- Commissioning and parameterizing using the BOP20 and AOP30 operator panels and the STARTER PC program
- Using the memory card: Structure and data backup
- Procedure when commissioning, checking functions
- Optimizing the closed-loop current and speed control, automatic optimization
- Function diagrams: Setpoint channel, inputs and outputs, free function blocks
- Information on Drive Control Chart DCC
- Drive interface to PROFIBUS / PROFINET
- Expanding the system using Terminal Modules and Sensor Modules via DRIVE-CLiQ
- Parallel circuit configuration and peer-to-peer coupling
- Operating states, alarms and fault messages
- Service functions: Trace, measuring functions, diagnostics memory
- Practical exercises using AOP30 and STARTER on training equipment

Note:

This course is subject to export regulations
AL: N, ECCN: EAR99T

Duration 5 days

Order code: DR-DCM

SINAMICS DCM

Services and documentation

Service & Support
Services covering the entire life cycle

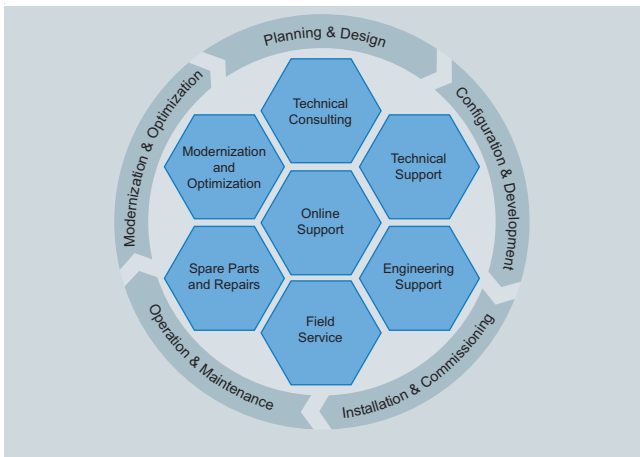

Our Service & Support accompanies you worldwide in all concerns related to the automation and drive technology of Siemens. In more than 100 countries directly on site and covering all phases of the life cycle of your machines and plants. Round the clock.

An experienced team of specialists with their combined know-how is ready to assist you. Regular training courses and a close contact of our employees among each other – also across continents – assure a reliable service for multifaceted scopes.

Online Support



The comprehensive information system available round the clock via Internet ranging from Product Support and Service & Support services to Support Tools in the Shop.

<http://www.siemens.com/automation/service&support>

Technical Support



Competent consulting in technical questions covering a wide range of customer-oriented services for all our products and systems.

<http://www.siemens.com/automation/support-request>

Technical Consulting



Support in the planning and designing of your project from detailed actual-state analysis, target definition and consulting on product and system questions right to the creation of the automation solution.

Engineering Support

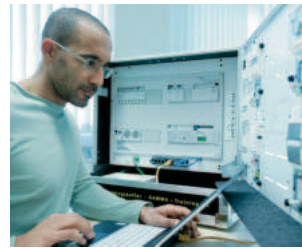

Support in configuring and developing with customer-oriented services from actual configuration to implementation of the automation project.

Field Service



With Field Service, we offer services for startup and maintenance essential for ensuring system availability.

Spare Parts and Repairs



In the operating phase of a machine or automation system, we provide a comprehensive repair and spare parts service ensuring the highest degree of plant availability.

Optimization and Upgrading



After startup or during the operating phase, additional potential for increasing the productivity or for reducing costs often arises. For this purpose, we offer you high-quality services in optimization and upgrading.

You find contact details in the Internet under:
<http://www.siemens.com/automation/service&support>

SINAMICS DCM

Services and documentation

Service & Support

Knowledge Base on DVD



For locations without online connections to the Internet there are excerpts of the free part of the information sources available on DVD (Service & Support Knowledge Base). This DVD contains all the latest product information at the time of production (FAQs, Downloads, Tips and Tricks, Updates) as well as general information on Service & Support.

The DVD also includes a full-text search and our Knowledge Manager for targeted searches for solutions. The DVD will be updated every 4 months.

Just the same as our online offer in the Internet, the Service & Support Knowledge Base on DVD comes complete in 5 languages (German, English, French, Italian, Spanish).

You can order the **Service & Support Knowledge Base** DVD from your Siemens contact.

Order No. **6ZB5310-0EP30-0BA2**

Automation Value Card



Small card – great support

The Automation Value Card is an integral component of the comprehensive service concept with which Siemens Automation and Drives will accompany you in each phase of your automation project.

It doesn't matter whether you want just specific services from our Technical Support or want to purchase something on our Online portal, you can always pay with your Automation Value Card. No invoicing, transparent and safe. With your personal card number and associated PIN you can view the state of your account and all transactions at any time.

Services on card. This is how it's done.

Card number and PIN are on the back of the Automation Value Card. When delivered, the PIN is covered by a scratch field, guaranteeing that the full credit is on the card.

By entering the card number and PIN you have full access to the Service & Support services being offered. The charge for the services procured is debited from the credits on your Automation Value Card.

All the services offered are marked in currency-neutral credits, so you can use the Automation Value Card worldwide.

Order your Automation Value Card easily and comfortably like a product with your sales contact.

Automation Value Card order numbers

Credits	Order No.
200	6ES7 997-0BA00-0XA0
500	6ES7 997-0BB00-0XA0
1 000	6ES7 997-0BC00-0XA0
10 000	6ES7 997-0BG00-0XA0

Detailed information on the services offered is available on our Internet site at:

<http://www.siemens.com/automation/service&support>

Service & Support à la Card: Examples

Technical Support

"Priority"	Priority processing for urgent cases
"24 h"	Availability round the clock
"Extended"	Technical consulting for complex questions
"Mature Products"	Consulting service for products that are not available any more

Support Tools in the Support Shop

Tools that can be used directly for configuration, analysis and testing

Overview

Documentation is supplied as standard on DVD together with the converter. German, English, French, Spanish, Italian and Russian are the standard languages. The documentation can be

additionally ordered as hard copy in the languages specified below.

Selection and ordering data

Documentation for SINAMICS DC MASTER

Documentation	Language	Order No.
Operating Instructions DC Converters	German	6RX1800-0AD00
	English	6RX1800-0AD76
	French	6RX1800-0AD77
	Spanish	6RX1800-0AD78
	Italian	6RX1800-0AD72
	Russian	6RX1800-0AD56
Operating Instructions Control Module	German	6RX1800-0BD00
	English	6RX1800-0BD76
	French	6RX1800-0BD77
	Spanish	6RX1800-0BD78
	Italian	6RX1800-0BD72
	Russian	6RX1800-0BD56
List Manual	German	6RX1800-0ED00
	English	6RX1800-0ED76
	French	6RX1800-0ED77
	Spanish	6RX1800-0ED78
	Italian	6RX1800-0ED72
	Russian	6RX1800-0ED56
Function Manual SINAMICS Free function blocks	German	6RX1800-0FD00
	English	6RX1800-0FD76
Set of manuals DC Converters and Control Module includes the Operating Instructions, List Manual and Function Manual Free function blocks ¹⁾	German	6RX1800-0GD00
	English	6RX1800-0GD76
	French	6RX1800-0GD77
	Spanish	6RX1800-0GD78
	Italian	6RX1800-0GD72
	Russian	6RX1800-0GD56

Documentation on DVD

Documentation	Language	Order No.
All documentation in all languages on DVD ¹⁾	German, English, French, Spanish, Italian and Russian	6RX1800-0AD64

¹⁾ Function Manual Free function blocks only in German and English.

SINAMICS DCM

Services and documentation

Notes

Appendix



8/2	Subject index
8/5	Order number index
8/6	List of abbreviations
8/7	Partner at Industry Automation and Drive Technologies
8/8	Online Services – Information and Ordering in the Internet and on DVD
8/8	Siemens Industry Automation and Drive Technologies in the WWW
8/8	Product Selection Using the Offline Mall of Industry
8/8	Easy Shopping with the Industry Mall
8/9	Conditions of sale and delivery
8/9	Export regulations
8/10	DVD-ROM included with Catalog D 23.1 · 2010

Subject index

	Part/Page		Part/Page
A		C (continued)	
Accessories	4/1	CUD	2/2, 3/32, 3/35, 4/4
Accessories – Control Module	3/53	Current controller	3/5
Actual speed	3/4	Current limiting	3/5
Advanced CUD	2/2, 3/32, 3/35, 4/4, 4/6, 4/9	D	
Advanced Operator Panel AOP30	3/10, 3/46, 4/2	DC Converter	3/10, 3/38
Analog outputs	3/48	DC fuse	3/30, 3/31, 4/12 ... 4/15
Analog user-assignable inputs	3/48	Description of options	3/35
AOP30	3/10, 3/46, 4/2	Design – Control Module	3/51
Appendix	8/1	Diagnostics	3/47
Application – Control Module	3/51	Dimension drawings	8/10
Application – DC Converter and Control Module	3/3	Documentation	3/9, 7/7
Approvals	3/11, 3/35, 4/4, 4/7, 4/10, 4/27	Drive components, communication	3/6
Arm fuses	4/13 ... 4/15	Drive Control Chart (DCC)	2/3, 3/45, 6/5
Armature circuit, closed-loop control	3/4	Drive ES engineering software	6/6
Armature circuit, fuses	4/12	DRIVE-CLiQ	2/3, 3/6, 4/4, 4/5, 4/7
Armature supply	3/32, 3/36	Duty cycles for four-quadrant operation	5/18
Assignment of terminals and connectors	3/39	Duty cycles for two-quadrant operation	5/17
Automation Value Card	7/6	DVD	8/8
Auto-reversing module	3/5	DVD-ROM included with Catalog D 23.1 · 2010	8/10
Available options	3/32	Dynamic overload capability	5/2
B		E	
Basic information about EMC	5/22	Electronics power supply	2/3, 3/32, 3/36, 3/41
Basic Operator Panel BOP20	3/10, 3/45	EMC	5/22
Benefits – DC Converter and Control Module	3/3	EMC-compliant drive installation	5/24
Binary inputs	3/48	EMF controller	3/6
Binary outputs	3/48	Engineering	6/1
Block library for SIMATIC PCS7	6/7	Engineering information	5/1
BOP20	3/10, 3/45	Engineering software Drive ES	6/6
Bridge circuit B6C and (B6)A(B6)C – three-phase	5/28	Engineering Support	7/5
Brush length	3/49	Engineering tool SIZER LD web	6/2
C		E-STOP	3/49
Cable	5/21	Expandable functionality using SINAMICS components	2/3
Cable length	5/21	Export regulations	8/9
CBE20	3/32, 3/35	F	
Characteristic values of the pulse tachometer evaluation electronics	5/21	Fans	3/32, 3/36, 3/42
Characteristics – dynamic overload capability	5/4 ... 5/15	Field circuit	3/40
Circuit-breakers	4/19	Field circuit, closed-loop control	3/6
Closed-loop control	3/46	Field circuit, fuses	4/12
Closed-loop control in the armature circuit	3/4	Field current controller	3/6
Closed-loop control in the field circuit	3/6	Field power section	3/32, 3/36
Closed-loop control section	3/42	Field power supply	2/2
Coated PCBs	2/3, 3/32, 3/36	Field power supply in line with requirements	2/2
Commissioning SINAMICS DCM	7/4	Field Service	7/5
Commissioning tool STARTER	6/3	Filters	4/19
Communication between drive components	3/6	Free function blocks	2/3, 3/44
Communication Board CBE20	3/32, 3/35	Function blocks, free	2/3, 3/44
Commutating reactors	4/16	Function of the inputs and outputs	3/48
Components for converter units, arrangement	5/27	Functionality using SINAMICS components	2/3
Components, supplementary	4/1	Functions of the closed-loop control in the armature circuit	3/4
Conditions of delivery	8/9	Functions of the closed-loop control in the field circuit	3/6
Conditions of sale	8/9	Fuses for the armature circuit	4/12
Configuration	1/12	Fuses for the field circuit	4/12
Connection, single-phase	2/3	G	
Connector Board	3/43	Gating unit	3/5, 3/6
Connectors	3/39	General information – DC Converter and Control Module	3/2
Contact	8/7	General technical data – DC Converter	3/11
Contactors	4/19	H	
Control Module	3/51	Hands-on training from the manufacturer	7/3
Control terminal block	3/49	Harmonics	5/28
Control Units	3/37	High inductances, supply	5/20
Coolant temperature	3/8	Highlights	2/1
Cooling	3/45		
Copper busbars, nickel-plated	2/3, 3/32, 3/36		

	Part/Page		Part/Page
I		P	
Industry Mall	0/6	Parallel connection of SINAMICS DC MASTER units	5/19
Information and Ordering in the Internet and on DVD	8/8	Parameterizing devices	3/45
Input pulse levels	5/21	Peer-to-peer protocol	3/49
Inputs, functions	3/48	Phase fuses	3/30, 3/31, 4/12 ... 4/15
Installation altitude	3/8		
Interface to the motor	3/50	Platform concept and Totally Integrated Automation	1/2
Interfaces, serial	3/49	Power section	3/39, 3/45
Interference suppression filter	4/19	Power section isolated with respect to ground	2/3
Internet	8/8	Precontrol	3/5
Introduction	1/1	Product Selection Using the Offline Mall of Industry	8/8
IP20 – mounting kit to upgrade	4/11	PROFIBUS as standard	2/2
		“PROFIBUS DP” communications software	6/7
K		“PROFINET IO” communications software	6/7
Knowledge Base on DVD	7/6	PROFINET optional	2/2
		Protection against condensation	5/20
L		Pulse operation – 12-pulse	5/20
Levels, input pulses	5/21	Pulse tachometer evaluation electronics, characteristic values	5/21
Line-side harmonics	5/28		
List of abbreviations	8/6	Q	
Load classes	5/15, 5/16	Quality according to DIN EN ISO 9001	1/3
M		R	
Mall	0/6, 8/8	Radio interference suppression filters	4/19, 5/26
Members of the SINAMICS drive family	1/6	Radio interference suppression filters from EPCOS	4/19
Memory card	3/32, 3/36	Radio interference suppression filters from Siemens	4/20
Monitoring	3/47	Ramp-function generator	3/4
More information – DC Converter and Control Module	3/9	Range of training courses	7/4
Motor fan airflow	3/50	Redundant operation	5/19
Motor temperature	3/50	Repairs	7/5
Mounting kit to upgrade to IP20	4/11	Rules for EMC-compliant installation	5/24
N		S	
Nickel-plated copper busbars	2/3	Safety shutdown (E-STOP)	3/49
Notes for EMC-compliant installation	5/22	Schematics – Control Module	3/54
		Schematics – Control Units	3/37
O		Schematics – DC Converter	3/38
Offline Mall	8/8	Schematics SIMOREG CCP	4/32, 4/33
Online services	8/8	Selection and ordering data – Control Module	3/52
Online Support	7/5	Selection and ordering data DC Converter for four-quadrant operation	3/31
Open-loop control section	3/42	Selection and ordering data DC Converter for two-quadrant operation	3/30
Open-loop drive control	3/46	Selection matrix, options	3/33
Operation, 12-pulse	5/20	Sensor Module Cabinet-Mounted SMC30	4/4
Operation, single-phase	3/8	Sensors, external	3/32, 3/36
Optimization	7/5	Serial interfaces	3/49
Option selection matrix	3/33	Service & Support	7/5
Options	3/32	Services	7/1
Options, description	3/35	SETUP program	6/7
Order number index	8/5	Shield connection	5/21, 5/26
Ordering examples	3/34	Shielding	5/25
Outputs, functions	3/48	SICROWBAR AC	4/21 ... 4/23
Overload capability, dynamic	5/2	SICROWBAR DC	4/24 ... 4/27
Overview – DC Converter	3/10	SICROWBAR overvoltage protection	4/21 ... 4/27
Overview – DC Converter and Control Module	3/2	Siemens DC motors	3/50
Overview, closed-loop control structure	3/7	Siemens Industry Automation and Drive Technologies in the WWW	8/8
Overvoltage protection	4/21		

Subject index

	Part/Page		Part/Page
S (continued)		T	
SIMOREG CCP	4/28	Technical Consulting	7/5
SIMOREG CM	3/2	Technical specifications – Control Module	3/52
SINAMICS DC converters	1/6	Technical specifications – DC Converter	3/10
SINAMICS DC MASTER for 12-pulse operation	5/20	Technical specifications – SINAMICS DC MASTER converters	3/12
SINAMICS DC MASTER to supply high inductances	5/20	Technical Support	7/5
SINAMICS DCM	1/6	Temperature range, wide	2/4
SINAMICS DCM demonstration case	7/2	Terminal Module TM15	4/5
SINAMICS DCM series of converters	1/10	Terminal Module TM31	4/8
SINAMICS drive family	2/2	Terminals	3/39
SINAMICS G110	1/7	Terminals on Connector Board	3/43
SINAMICS G110D	1/7	The SINAMICS drive family	1/2
SINAMICS G120	1/7	Three-phase bridge circuit B6C and (B6)A(B6)C	5/28
SINAMICS G120D	1/7	TM15	4/5
SINAMICS G130, SINAMICS G150	1/8	TM31	4/8
SINAMICS GL150	1/9	Tools	6/1
SINAMICS GM150	1/9	Torque limiting	3/5
SINAMICS Link	3/6	Totally Integrated Automation	0/4, 1/2
SINAMICS low-voltage converters	1/7	Training	7/3
SINAMICS medium-voltage converters	1/9		
SINAMICS S110	1/8	U	
SINAMICS S120	1/8	Upgrade to IP20	4/11
SINAMICS S150	1/8	Upgrading	7/5
SINAMICS SM150	1/9	USS protocol	3/49
SINAMICS, members of the drive family	1/6	“USS-Protocol” communications software	6/7
SINAMICS, the drive family	1/2		
Single-phase connection	2/3	V	
Single-phase operation	3/8	Variance of the Control Units	2/2
SITRAIN	7/3		
SIZER LD web engineering tool	6/2	W	
SMC30	4/4	WWW	8/8
Spare Parts	7/5		
Speed controller	3/5		
Speed setpoint	3/4		
Standard CUD	2/2, 3/32, 3/35, 4/4		
Standards	3/10, 4/27, 5/22, 5/23		
STARTER commissioning tool	6/3		
STEP 7 device object manager	6/7		
STEP 7 slave object manager	6/7		
Supplementary components	4/1		
Supply of high inductances	5/20		
Switching frequency	5/21		
System components of a DC drive	1/11		

Order number index

Part/Page

3NE...	Fuses	4/12 ... 4/15
4EM...	Commutating reactors	4/17
4EP...	Commutating reactors	4/17, 4/18
4EU...	Commutating reactors	4/17, 4/18
5SD...	Fuse	4/12
6AU1810-1...	Drive Control Chart (DCC)	6/5
6ES7901-4BD00-0XA0 6ES7997-...	Connecting cable between CP 5512 and PROFIBUS Automation Value Card	6/4 7/6
6GK1551-2AA00	PROFIBUS communication module CP 5512	6/4
6RA70...	SIMOREG CCP	4/31
6RA8000-0MV62-0AA0	Control Module	3/52
6RA801...	DC Converter for four-quadrant operation	3/31
6RA802...	DC Converter for two-quadrant operation and four-quadrant operation	3/30, 3/31
6RA803...	DC Converter for two-quadrant operation and four-quadrant operation	3/30, 3/31
6RA807...	DC Converter for two-quadrant operation and four-quadrant operation	3/30, 3/31
6RA808...	DC Converter for two-quadrant operation and four-quadrant operation	3/30, 3/31
6RA809...	DC Converter for two-quadrant operation and four-quadrant operation	3/30, 3/31
6RX1800-0AD...	Operating Instructions DC Converters	7/7
6RX1800-0AD64	All documentation in all languages on DVD	7/7
6RX1800-0BD...	Operating Instructions Control Module	7/7
6RX1800-0ED...	List Manual	7/7
6RX1800-0FD...	Function Manual SINAMICS Free function blocks	7/7
6RX1800-0GD...	Set of manuals DC Converters and Control Module	7/7
6RX1800-0MA...	Mounting kit to upgrade to IP20	4/11
6RY1702-...	Arm fuses	4/13, 4/14
6RY1707-0AA08	Patch cable UTP CAT5	4/31
6RY1707-0C...	Pre-fabricated connection set	3/53
6RY1805-0CM00	Rear enclosure part including accessories	3/53
6RY1807-0A...	RS485 cable to connect the AOP to a CUD or to two CUDs	4/3
6RY1807-0C...	Pre-fabricated connection sets and mounting parts	3/53
6SL3055-0AA00-3AA1	TM31 Terminal Module	4/10
6SL3055-0AA00-3FA0	TM15 Terminal Module	4/7
6SL3055-0AA00-4CA4	AOP30 Advanced Operator Panel	4/3
6SL3055-0AA00-5CA2	SMC30 Sensor Module Cabinet-Mounted	4/4
6SL3060-...	Pre-fabricated DRIVE-CLiQ cables	4/7
6SL3072-0AA00-0AG0	STARTER commissioning tool	6/3
6SW1700-...	Drive ES engineering software	6/7, 6/8
7VV3002-...	SICROWBAR AC overvoltage protection	4/23
7VV3003-...	SICROWBAR DC overvoltage protection	4/27

Appendix

List of abbreviations

Abbreviation	Meaning	Abbreviation	Meaning
AC	Alternating Current	LCD	Liquid Crystal Display
AOP30	Advanced Operator Panel	LED	Light Emitting Diode
AWG	American Wire Gauge	MTBF	Mean Time Between Failure
BICO	Binector/Connector Technology	PC	Personal Computer
BOD	Break-Over Diode	PCB	Printed Circuit Board
BOP20	Basic Operator Panel	PCS	Process Control System
CBE	Communication Board	PDS	Power Drive System
CDS	Command Data Set	PE	Protective Earth
CM	Control Module	PG	Programming device (Programmiergerät)
CU	Control Unit	PKW	Parameter identifier value (Parameter Kennung Wert)
CUD	Control Unit DC	PTC	Positive Temperature Coefficient
DC	Direct Current	PZD	Process data (Prozessdaten)
DCB	Drive Control Block	RAM	Random Access Memory
DCC	Drive Control Chart	SMC30	Sensor Module
DCM	DC MASTER	SSO	Single Sign-On
DDS	Drive Data Set	TIA	Totally Integrated Automation
DIN	German Institute for Standardization (Deutsches Institut für Normung e.V.)	TIP	Totally Integrated Power
DRIVE-CLiQ	Drive Component Link with IQ	TM15, TM31	Terminal Module
EMC	Electromagnetic Compatibility	TTL	Transistor-Transistor Logic
EMF	Electromotive Force	UL	Underwriters Laboratories Inc.
EN	European standard (Europäische Norm)	UPS	Uninterruptible Power Supply
EPROM	Erasable Programmable Read Only Memory	USS	Universal serial interface (Universelle Serielle Schnittstelle)
E-STOP	Emergency Stop	VDE	Association of Electrical Engineering, Electronics and Information Technology (Germany) (Verband der Elektrotechnik Elektronik Informationstechnik e.V.)
ES	Engineering System		
HTL	High-level Transistor Logic		
IEC	International Electrotechnical Commission		
IP	International Protection		

Partner at Industry Automation and Drive Technologies



At Siemens Industry Automation and Drive Technologies, more than 85 000 people are resolutely pursuing the same goal: long-term improvement of your competitive ability. We are committed to this goal. Thanks to our commitment, we continue to set new standards in automation and drive technology. In all industries – worldwide.

At your service locally, around the globe for consulting, sales, training, service, support, spare parts... on the entire Industry Automation and Drive Technologies range.

Your personal contact can be found in our Contacts Database at: <http://www.automation.siemens.com/mcms/aspa-db/>

You start by selecting a

- Product group,
- Country,
- City,
- Service.



SINAMICS DCM

Appendix

Online Services – Information and Ordering in the Internet and on DVD

Siemens Industry Automation and Drive Technologies in the WWW



A detailed knowledge of the range of products and services available is essential when planning and configuring automation systems. It goes without saying that this information must always be fully up-to-date.

Siemens Industry Automation and Drive Technologies has therefore built up a comprehensive range of information in the World Wide Web, which offers quick and easy access to all data required.

Under the address

<http://www.siemens.com/automation>

you will find everything you need to know about products, systems and services.

Product Selection Using the Offline Mall of Industry



Detailed information together with convenient interactive functions:

The Offline Mall CA 01 covers more than 80 000 products and thus provides a full summary of the Siemens Industry Automation and Drive Technologies product base.

Here you will find everything that you need to solve tasks in the fields of automation, switchgear, installation and drives. All information is linked into a user interface which is easy to work with and intuitive.

After selecting the product of your choice you can order at the press of a button, by fax or by online link.

Information on the Offline Mall CA 01 can be found in the Internet under

<http://www.siemens.com/automation/ca01>

or on DVD.

Easy Shopping with the Industry Mall



The Industry Mall is the virtual department store of Siemens AG in the Internet. Here you have access to a huge range of products presented in electronic catalogs in an informative and attractive way.

Data transfer via EDIFACT allows the whole procedure from selection through ordering to tracking of the order to be carried out online via the Internet.

Numerous functions are available to support you.

For example, powerful search functions make it easy to find the required products, which can be immediately checked for availability. Customer-specific discounts and preparation of quotes can be carried out online as well as order tracking and tracing.

Please visit the Industry Mall in the Internet under:

<http://www.siemens.com/industrymall>

Conditions of sale and delivery Export regulations

Terms and Conditions of Sale and Delivery

By using this catalog you can acquire hardware and software products described therein from Siemens AG subject to the following terms. Please note! The scope, the quality and the conditions for supplies and services, including software products, by any Siemens entity having a registered office outside of Germany, shall be subject exclusively to the General Terms and Conditions of the respective Siemens entity. The following terms apply exclusively for orders placed with Siemens AG.

For customers with a seat or registered office in Germany

The "General Terms of Payment" as well as the "General Conditions for the Supply of Products and Services of the Electrical and Electronics Industry" shall apply.

For software products, the "General License Conditions for Software Products for Automation and Drives for Customers with a Seat or registered Office in Germany" shall apply.

For customers with a seat or registered office outside of Germany

The "General Terms of Payment" as well as the "General Conditions for Supplies of Siemens Automation and Drives for Customers with a Seat or registered Office outside of Germany" shall apply.

For software products, the "General License Conditions for Software Products for Automation and Drives for Customers with a Seat or registered Office outside of Germany" shall apply.

General

The dimensions are in mm. In Germany, according to the German law on units in measuring technology, data in inches only apply to devices for export.

Illustrations are not binding.

Insofar as there are no remarks on the corresponding pages, – especially with regard to data, dimensions and weights given – these are subject to change without prior notice.

The prices are in € (Euro) ex works, exclusive packaging.

The sales tax (value added tax) is not included in the prices. It shall be debited separately at the respective rate according to the applicable legal regulations.

Prices are subject to change without prior notice. We will debit the prices valid at the time of delivery.

Surcharges will be added to the prices of products that contain silver, copper, aluminum, lead and/or gold if the respective basic official prices for these metals are exceeded. These surcharges will be determined based on the official price and the metal factor of the respective product.

The surcharge will be calculated on the basis of the official price on the day prior to receipt of the order or prior to the release order.

The metal factor determines the official price as of which the metal surcharges are charged and the calculation method used. The metal factor, provided it is relevant, is included with the price information of the respective products.

An exact explanation of the metal factor and the text of the Comprehensive Terms and Conditions of Sale and Delivery are available free of charge from your local Siemens business office under the following Order Nos.:

- 6ZB5310-0KR30-0BA1
(for customers based in Germany)
- 6ZB5310-0KS53-0BA1
(for customers based outside Germany)

or download them from the Internet
www.siemens.com/industrymall
(Germany: Industry Mall Online-Help System)

Export regulations

The products listed in this catalog may be subject to European / German and/or US export regulations.

Therefore, any export requiring a license is subject to approval by the competent authorities.

According to current provisions, the following export regulations must be observed with respect to the products featured in this catalog:

AL	Number of the <u>German Export List</u> Products marked other than "N" require an export license. In the case of software products, the export designations of the relevant data medium must also be generally adhered to. Goods labeled with an " <u>AL</u> " not equal to "N" are subject to a European or German export authorization when being exported out of the EU.
ECCN	<u>Export Control Classification Number</u> Products marked other than "N" are subject to a reexport license to specific countries. In the case of software products, the export designations of the relevant data medium must also be generally adhered to. Goods labeled with an " <u>ECCN</u> " not equal to "N" are subject to a US re-export authorization.

Even without a label or with an "AL: N" or "ECCN: N", authorization may be required due to the final destination and purpose for which the goods are to be used.

The deciding factors are the AL or ECCN export authorization indicated on order confirmations, delivery notes and invoices.

Errors excepted and subject to change without prior notice.

I IA/DT/VuL_ohne MZ/En 16.03.10

Appendix

DVD-ROM included with Catalog D 23.1 · 2010

On the DVD-ROM included with Catalog D 23.1 · 2010, you will find:

- Manuals, SINAMICS DCM and SICROWBAR AC/DC
- GSD files
- Function block diagrams in the VSD format
- Dimension drawings of the DC Converter and Control Module in the DXF and PDF formats
- STARTER commissioning tool
- Spare parts list in the XLS format
- Catalog D 23.1 · 2010 in the PDF format
- Information about service and support

The contents of the DVD correspond to the catalog edition. Current versions are provided in the Internet and on every DVD supplied with the equipment.

Hardware and software requirements

- DVD-ROM drive
- Windows from XP
- Adobe Reader from 7.0
- MS Internet Explorer from V6.0 (SP2)

Start

Insert the DVD-ROM into your DVD-ROM drive.
Run the "start.htm" file from the DVD-ROM in your Windows Explorer.

Note:

No software has to be installed to view the information on this DVD-ROM. The only exception is when using the dimension drawings in the DXF format.

Industry Automation, Drive Technologies and Low Voltage Distribution

Further information can be obtained from our branch offices listed in the appendix or at www.siemens.com/automation/partner

Interactive Catalog on DVD	<i>Catalog</i>	Motion Control	<i>Catalog</i>
for Industry Automation, Drive Technologies and Low Voltage Distribution	CA 01	SINUMERIK & SIMODRIVE Automation Systems for Machine Tools	NC 60
Drive Systems		SINUMERIK & SINAMICS Equipment for Machine Tools	NC 61
<u>Variable-Speed Drives</u>		SIMOTION, SINAMICS S120 and Motors for Production Machines	PM 21
SINAMICS G110, SINAMICS G120	D 11.1	SINAMICS S110 The Basic Positioning Drive	PM 22
Standard Inverters			
SINAMICS G110D, SINAMICS G120D			
Distributed Inverters			
SINAMICS G130 Drive Converter Chassis Units	D 11		
SINAMICS G150 Drive Converter Cabinet Units			
SINAMICS GM150, SINAMICS SM150	D 12		
Medium-Voltage Converters			
SINAMICS S120 Chassis Format Units and Cabinet Modules	D 21.3		
SINAMICS S150 Converter Cabinet Units			
SINAMICS DCM Converter Units	D 23.1		
<u>Three-phase Induction Motors</u>	D 84.1		
• H-compact			
• H-compact PLUS			
Asynchronous Motors Standardline	D 86.1		
Synchronous Motors with Permanent-Magnet Technology, HT-direct	D 86.2		
DC Motors	DA 12		
SIMOREG DC-MASTER 6RA70 Digital Chassis Converters	DA 21.1		
SIMOREG K 6RA22 Analog Chassis Converters	DA 21.2		
<i>PDF: SIMOREG DC-MASTER 6RM70 Digital Converter Cabinet Units</i>	DA 22		
SIMOVERT PM Modular Converter Systems	DA 45		
SIEMOSYN Motors	DA 48		
MICROMASTER 420/430/440 Inverters	DA 51.2		
MICROMASTER 411/COMBIMASTER 411	DA 51.3		
SIMOVERT MASTERDRIVES Vector Control	DA 65.10		
SIMOVERT MASTERDRIVES Motion Control	DA 65.11		
Synchronous and asynchronous servomotors for SIMOVERT MASTERDRIVES	DA 65.3		
SIMODRIVE 611 universal and POSMO	DA 65.4		
SIMOTION, SINAMICS S120 and Motors for Production Machines	PM 21		
SINAMICS S110 The Basic Positioning Drive	PM 22		
<u>Low-Voltage Three-Phase-Motors</u>			
IEC Squirrel-Cage Motors	D 81.1		
MOTOX Geared Motors	D 87.1		
<u>Automation Systems for Machine Tools SIMODRIVE</u>	NC 60		
• Motors			
• Converter Systems SIMODRIVE 611/POSMO			
<u>Automation Systems for Machine Tools SINAMICS</u>	NC 61		
• Motors			
• Drive System SINAMICS S120			
<u>Drive and Control Components for Hoisting Equipment</u>	HE 1		
<u>Mechanical Driving Machines</u>			
Flender Standard Couplings	MD 10.1		
Electrical Installation Technology			
<i>PDF: ALPHA Distribution Boards and Terminal Blocks</i>	ETA 1		
<i>PDF: ALPHA 8HP Molded-Plastic Distribution System</i>	ETA 3		
<i>PDF: BETA Low-Voltage Circuit Protection</i>	ET B1		
<i>PDF: DELTA Switches and Socket Outlets</i>	ET D1		
<i>PDF: GAMMA Building Management Systems</i>	ET G1		
		Low-Voltage	
		Controls and Distribution – SIRIUS, SENTRON, SIVACON	LV 1
		SICUBE System Cubicles and Cubicle Air-Conditioning	LV 50
		<i>PDF: SIDAC Reactors and Filters</i>	LV 60
		<i>PDF: SIVACON 8PS Busbar Trunking Systems</i>	LV 70
		Low-Voltage Controls and Distribution – SIRIUS, SENTRON, SIVACON	LV 90
		Power Supply and System Cabling	
		Power supply SITOP	KT 10.1
		System cabling SIMATIC TOP connect	KT 10.2
		Process Instrumentation and Analytics	
		Field Instruments for Process Automation	FI 01
		<i>PDF: Indicators for panel mounting</i>	MP 12
		SIREC Recorders and Accessories	MP 20
		SIPART, Controllers and Software	MP 31
		<i>PDF: Products for Weighing Technology</i>	WT 10
		Process Analytical Instruments	PA 01
		<i>PDF: Process Analytics, Components for the System Integration</i>	PA 11
		Safety Integrated	
		Safety Technology for Factory Automation	SI 10
		SIMATIC HMI	
		Human Machine Interface Systems	ST 80
		SIMATIC Industrial Automation Systems	
		Products for Totally Integrated Automation and Micro Automation	ST 70
		SIMATIC PCS 7 Process Control System	ST PCS 7
		Add-ons for the SIMATIC PCS 7 Process Control System	ST PCS 7.1
		<i>PDF: Migration solutions with the SIMATIC PCS 7 Process Control System</i>	ST PCS 7.2
		pc-based Automation	ST PC
		SIMATIC NET	
		Industrial Communication	IK PI
		SIMATIC Sensors	
		Sensor Technology for Factory Automation	FS 10
		Industrial Identification Systems	ID 10
		System Solutions	
		Applications and Products for Industry are part of the interactive catalog CA 01	

PDF: These catalogs are only available as pdf files.

Siemens AG
Industry Sector
Drive Technologies Division
Large Drives
Postfach 48 48
90026 NÜRNBERG
GERMANY

www.siemens.com/sinamics

Subject to change without prior notice
Order No. E86060-K5523-A111-A1-7600
3P.8222.88.12 / Dispo 18402
KG 0510 6.0 E 168 En
Printed in Germany
© Siemens AG 2010

The information provided in this catalog contains descriptions or characteristics of performance which in case of actual use do not always apply as described or which may change as a result of further development of the products. An obligation to provide the respective characteristics shall only exist if expressly agreed in the terms of contract. Availability and technical specifications are subject to change without notice.

All product designations may be trademarks or product names of Siemens AG or supplier companies whose use by third parties for their own purposes could violate the rights of the owners.

Token fee: 5.00 €

SIEMENS

Catalog D23.1-2010

SINAMICS DCM Converter Units

men's AG